

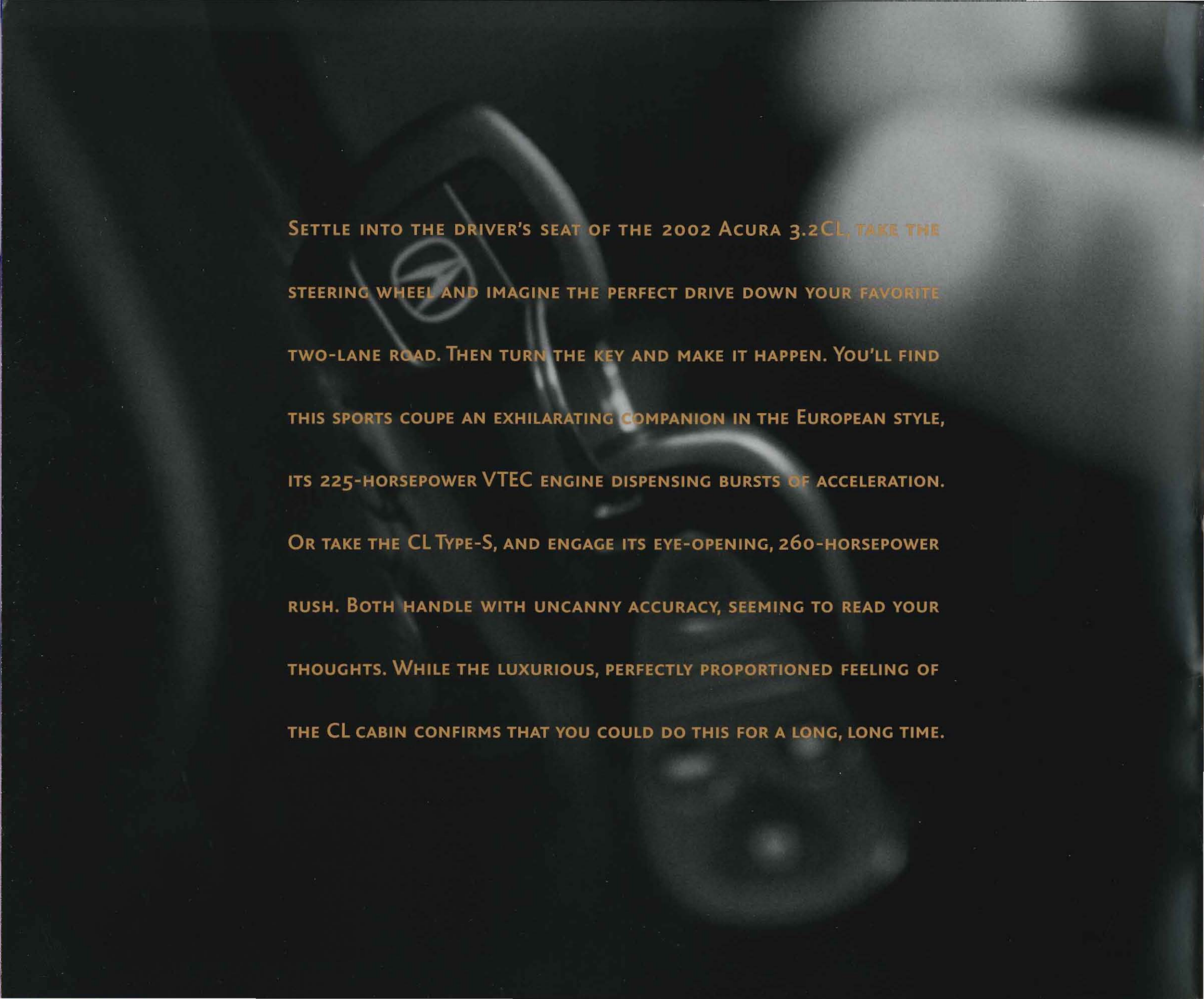

ACURA CL 2002





SETTLE INTO THE DRIVER'S SEAT OF THE 2002 ACURA 3.2CL, TAKE THE
STEERING WHEEL AND IMAGINE THE PERFECT DRIVE DOWN YOUR FAVORITE
TWO-LANE ROAD. THEN TURN THE KEY AND MAKE IT HAPPEN. YOU'LL FIND
THIS SPORTS COUPE AN EXHILARATING COMPANION IN THE EUROPEAN STYLE,
ITS 225-HORSEPOWER VTEC ENGINE DISPENSING BURSTS OF ACCELERATION.
OR TAKE THE CL TYPE-S, AND ENGAGE ITS EYE-OPENING, 260-HORSEPOWER
RUSH. BOTH HANDLE WITH UNCANNY ACCURACY, SEEMING TO READ YOUR
THOUGHTS. WHILE THE LUXURIOUS, PERFECTLY PROPORTIONED FEELING OF
THE CL CABIN CONFIRMS THAT YOU COULD DO THIS FOR A LONG, LONG TIME.





"I travel for travel's sake." ROBERT LOUIS STEVENSON



ACURA CL TYPE-S SHOWN IN SATIN SILVER METALLIC.



THAT RACECAR FEELING JUST RUNS IN THE FAMILY.

The sound and fury you experience in driving the 2002 Acura 3.2CL™ to its full capability are evidence of a truly distinctive and rich heritage. The highly advanced engines that power the CL reflect the lessons learned in achieving six Constructor's World Championships on the Formula One Grand Prix racing circuit. In that forum of ferocious speed and unrelenting pressure, our engineers developed the systems and technologies that led to victory. And that eventually helped to create the two compelling engines that make this coupe a study in exhilaration.

The CL moves to the soul-stirring beat of a smooth, 3.2-liter, 24-valve V-6 engine that delivers both exciting power – 225 horsepower and 216 lbs-ft of torque – as well as amazing efficiency. While these virtues may seem to be incompatible, it's just the kind of challenge our engineers long to conquer. They've applied a variety of innovations that originated from our competition experience, such as

aluminum-alloy construction for high strength, reduced weight and excellent heat dissipation. A crankshaft made of forged steel that offers exceptional resistance to flexing. A 4-valve-per-cylinder configuration to optimize the flow of the intake and exhaust gases through the combustion chamber. Roller cam followers that help reduce friction and maintenance. And Acura's ingenious Variable Valve Timing and Lift Electronic Control (VTEC™) system that provides outstanding responsiveness at low engine speeds as well as impressive high-rpm horsepower.

We recognize that some driving enthusiasts expect something extra from their high-performance vehicles. For these adrenaline-seekers, we created the CL Type-S. It features enhancements such as a higher compression ratio, special cam profiles with longer duration and higher lift, and a high-flow, 2-stage intake manifold. The result is an increase in peak output to a blazing 260 horsepower

and 232 lbs-ft of torque. And the ability to attain the speed limit with breathtaking brevity.

Both CL powerplants employ our sophisticated PGM-FI programmed fuel-injection system, which provides exceptionally precise fuel delivery. Instead of inefficiently distributing high-voltage ignition impulses from a single source, our direct ignition delivers a hotter, more uniform spark by placing a high-tension ignition coil directly above each spark plug. The low-restriction exhaust system reduces backpressure for enhanced engine breathing – a concept taken even further in the Type-S with high-flow mufflers and larger-diameter exhaust pipes.

CL engines are built to go the distance. Thanks to durability advances including long-life timing belts and platinum-tipped spark plugs, these precision powerplants are designed to perform at peak levels for 100,000 miles without a scheduled tune-up.¹



IN THIS LABORATORY, OUR ENGINEERS GET QUICK RESULTS.

RACING ENABLES OUR ENGINEERS TO PUT THEIR DESIGNS TO THE MOST SEVERE TEST IMAGINABLE. AND THEY OFTEN PASS WITH FLYING CHECKERED-FLAG COLORS. ALONG WITH MORE THAN 50 VICTORIES IN THE HIGHLY COMPETITIVE CHAMPIONSHIP AUTO RACING TEAM (CART) SERIES, WE'VE ALSO WON SIX CONSTRUCTOR'S WORLD CHAMPIONSHIP TROPHIES ON THE GRUELING FORMULA ONE GRAND PRIX CIRCUIT. SHOWN HERE: BAR/HONDA DRIVER JACQUES VILLENEUVE COMPETES FOR THE 2001 FORMULA ONE WORLD CHAMPIONSHIP.



ACURA CL TYPE-S 3.2-LITER, 260-HORSEPOWER V-6 ENGINE.



IT TOOK QUICK THINKING TO BUILD THIS CAR.

Whether you drive the powerful 2002 Acura CL or the even stronger CL Type-S, you'll enjoy the direct benefits of some of the world's most advanced and hard-working powerplant engineering. And while these engines make for thrilling drives, they also feature remarkable efficiency, exceptional smoothness and outstanding durability.

Each CL engine is constructed primarily of a lightweight aluminum alloy that's immensely strong and durable. A 4-valve-per-cylinder design, proven in Formula One racing machines, helps provide superior engine breathing.

Our brilliant Variable Valve Timing and Lift Electronic Control (VTEC) system provides further refinement. In a conventional engine, valve timing and lift are stuck at

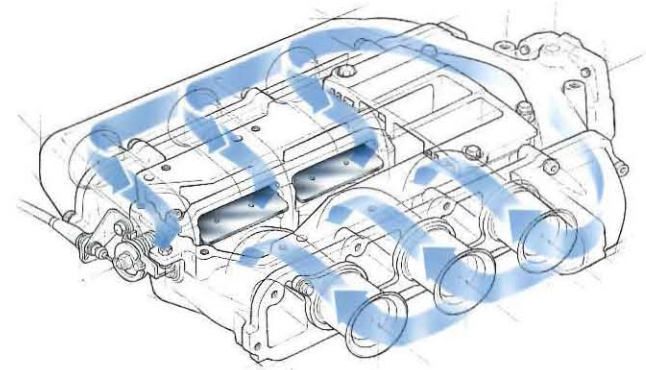

POWER, POWER EVERYWHERE

AT LOW SPEEDS, THE DUAL-STAGE INTAKE MANIFOLD ON THE TYPE-S IS ENGINEERED TO TAKE CLEVER ADVANTAGE OF RESONANCE ENERGY WITHIN EACH CYLINDER BANK TO PACK THE AIR/FUEL CHARGE INTO THE CYLINDERS. AS SPEEDS INCREASE, A VALVE OPENS INSIDE THE PLENUM CHAMBER THAT CANCELS THE RESONANCE AND LETS THE INERTIA OF THE INTAKE CREATE A SUPERCHARGE EFFECT.

DUAL-STAGE INTAKE MANIFOLD (CUTAWAY SHOWN)

THANKS IN LARGE PART TO THIS INNOVATIVE DESIGN, THE CL TYPE-S OFFERS EXCELLENT LOW-END TORQUE, IMPRESSIVE HIGH-RPM HORSEPOWER AND A SMOOTH, POWERFUL TRANSITION THROUGHOUT THE MIDRANGE. AN ELECTRONICALLY CONTROLLED, MOTOR-OPERATED VALVE TRIGGERS THE SWITCH BETWEEN THE LOW-SPEED AND HIGH-SPEED MODES AT 3800 RPM.

a single specification – a compromise between low-speed torque and high-rpm horsepower. But the VTEC system actually provides both, using two distinct cam profiles on the intake side. One provides more efficient flow at lower rpm for excellent response. As engine speed increases, the system engages the second cam profile to optimize the air/fuel flow for exceptional peak-horsepower output.

The CL Type-S gets dramatically increased power from enhancements such as higher compression and a

remarkable, dual-stage intake manifold. It helps increase and extend the Type-S power band across a broad range.

Yet for all their stunning power, these CL engines are environmentally friendly. A high-flow catalytic converter system helps reduce pollutants—especially during cold start-ups. As a result, the California-spec CL qualifies as an Ultra-Low-Emission Vehicle (ULEV). Perhaps even more remarkably, the 260-horsepower CL Type-S is certified as a Low-Emission Vehicle (LEV) in all 50 states.

Working with both CL powerplants is an automatic transmission of truly ingenious design. This electronically controlled gearbox incorporates five close-ratio gears for smoother, more powerful performance. And to provide manual-style shifting during spirited driving, the CL has a Formula One-inspired Sequential SportShift™ feature. It allows the driver to change gears by simply flicking the shift lever forward or back. Or, if you prefer, this 5-speed can function with the convenience of full automatic mode.

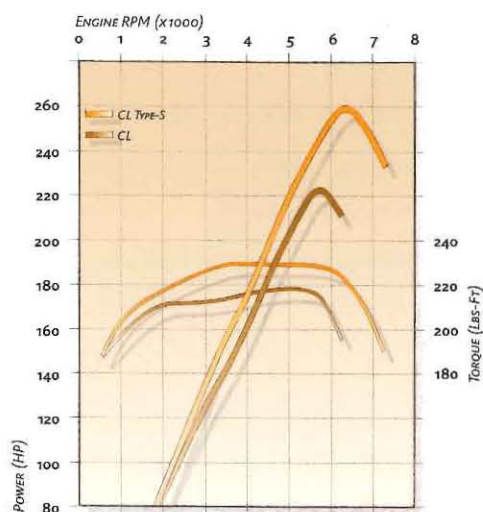

POWER AND TORQUE

THE 3.2-LITER, 24-VALVE V-6 IN THE CL DELIVERS AN IMPRESSIVE 225 HORSEPOWER AND 216 LBS-FT OF TORQUE. THE TYPE-S PRODUCES AN EVEN STRONGER 260 HORSEPOWER AND 232 LBS-FT OF TORQUE.

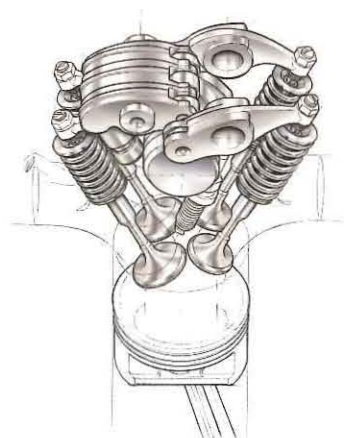

VARIABLE VALVE TIMING AND LIFT ELECTRONIC CONTROL (VTEC)

TO SWITCH FROM LOW-RPM INTAKE TIMING AND LIFT TO THE CAM PROFILE DESIGNED FOR HIGH-SPEED POWER, HYDRAULICALLY ACTUATED PINS LOCK THE TWO OUTBOARD ROCKER ARMS TO A THIRD ARM IN THE MIDDLE.



CLEANER-RUNNING VEHICLES

REMARKABLY, GIVEN ITS POWER, THE STANDARD V-6 QUALIFIES THE CALIFORNIA-SPEC CL AS AN ULTRA-LOW-EMISSION VEHICLE (ULEV). EVEN THE 260-HP TYPE-S V-6 EARNS LOW-EMISSION VEHICLE (LEV) STATUS.

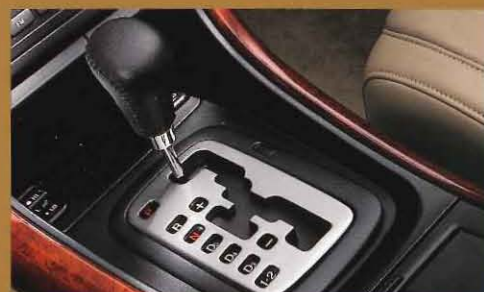

SPIN-CAST CYLINDER-LINER TECHNOLOGY

TO HELP THE REMARKABLY POWERFUL TYPE-S ENGINE PERFORM AS EFFICIENTLY AS POSSIBLE, ENGINEERS DEVELOPED A HIGHLY INNOVATIVE SPIN-CAST CYLINDER-LINER TECHNIQUE THAT FACILITATES ENGINE COOLING AND REDUCES ENGINE WEIGHT FOR IMPROVED OPERATING ECONOMY.

5-SPEED SEQUENTIAL SPORTSHIFT AUTOMATIC TRANSMISSION

THE ELECTRONICALLY CONTROLLED AUTOMATIC TRANSMISSION IN THE CL FEATURES FIVE GEARS—ALLOWING MORE CLOSELY SPACED GEAR RATIOS FOR SMOOTHER SHIFTS AND ENHANCED PERFORMANCE. THE CL 5-SPEED ALSO HAS A FORMULA ONE-INSPIRED SEQUENTIAL SPORTSHIFT SYSTEM THAT ALLOWS THE DRIVER TO MANUALLY CHANGE GEARS MERELY BY TAPPING THE SHIFT LEVER FORWARD OR BACK. AND THE UNIQUE GRADE LOGIC CONTROL SYSTEM ALL BUT ELIMINATES GEAR HUNTING ON HILLS BY HOLDING THE TRANSMISSION IN THE MOST APPROPRIATE GEAR.



IF THE SHORTEST DISTANCE IS A STRAIGHT LINE, BEND IT.

While the 2002 Acura CL is certainly a blast in the straightaways, its true sporting nature really comes out when the road gets twisty. Thanks to a Formula One-bred, 4-wheel independent double-wishbone suspension system, the CL conquers the curves with the precision, confidence and poise of a world-class European GT.

Razor-sharp handling and a smooth, forgiving ride are widely recognized benefits of the double-wishbone layout. But Acura's engineers set out to prove that this already impressive, racing-inspired suspension system has an even greater capacity for cornering excellence. And they succeeded, incorporating in the rear suspension a fifth link that provides additional directional stability and control when carving aggressively through turns and when driving over bumps and other uneven pavement.

Indeed, this car has been built from the ground up to get the most out of spirited driving. Both the CL and

CL Type-S are fitted with a set of handsome, lightweight alloy wheels—a 16-inch, 7-spoke style on the CL and a 17-inch, 5-spoke design on the Type-S. To help provide secure, sure-footed performance, P205/60 R16 All-Season tires grip the road on the CL. The high-output CL Type-S features wider, lower-profile P215/50 R17 tires. And the suspension system of the Type-S includes firmer springs and shocks as well as a beefier rear stabilizer bar that makes for crisper handling without sacrificing ride comfort.

Even greater cornering sophistication results from the Vehicle Stability Assist (VSA®) system that comes on the CL Type-S. Using electronic sensors, VSA constantly compares the driver's intended course with how the car is responding on the road. If the system detects impending oversteer or understeer, it can automatically apply brake pressure to the appropriate front wheel and/or reduce the throttle to help bring the car back onto its intended path.

Both models also have a Traction Control System (TCS) that detects wheelspin and, if necessary, brakes the slipping wheel for enhanced control in slippery conditions when starting out and at lower speeds. And to help improve traction in virtually every driving situation, the CL features a front-wheel-drive layout that positions the engine's weight directly over the vehicle's drive wheels.

Each CL model delivers the secure stopping power of a 4-wheel disc brake system with ventilated front discs, as well as an anti-lock braking system (ABS) that helps to maintain steering control during hard braking. The ABS on the CL is a three-channel system, apportioning braking power to the front wheels independently and to the rear wheels together. The Type-S system automatically switches to a four-channel mode when it senses high cornering forces, so the system can take advantage of weight transfer by applying greater brake pressure to the outside wheel.

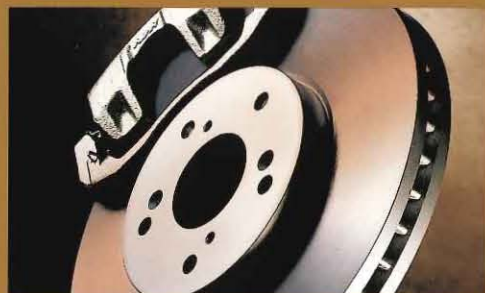

FRONT AND REAR DISC BRAKES

BOTH CL MODELS COME WITH A STANDARD 4-WHEEL DISC BRAKE SYSTEM FOR OUTSTANDING STOPPING POWER AND SECURE, FADE-RESISTANT PERFORMANCE. THE VENTILATED FRONT DISCS MEASURE 11.8 INCHES, AND THE SOLID REARS ARE 11.1-INCH UNITS. A COMPUTER-CONTROLLED ANTI-LOCK BRAKING SYSTEM (ABS) IS ALSO STANDARD. THIS SYSTEM HELPS THE DRIVER RETAIN EFFECTIVE STEERING CONTROL EVEN DURING MAXIMUM-EFFORT STOPS.

VEHICLE STABILITY ASSIST

THE CL TYPE-S COMES EQUIPPED WITH A VEHICLE STABILITY ASSIST (VSA) SYSTEM. ITS ELECTRONIC SENSORS CAN DETECT IMPENDING OVERSTEER OR UNDERSTEER, AND THE SYSTEM CAN AUTOMATICALLY APPLY BRAKING TO THE APPROPRIATE FRONT WHEEL AND/OR REDUCE THROTTLE TO HELP BRING THE CAR BACK TO ITS INTENDED COURSE.

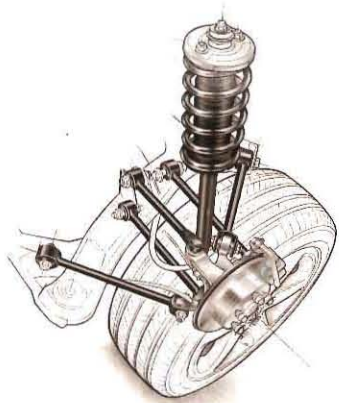

MULTI-LINK REAR SUSPENSION SYSTEM

THE DOUBLE-WISHBONE REAR SUSPENSION OF THE CL INCLUDES A FIFTH LINK, PLUS A UNIQUE PILLOW JOINT THAT HELPS RESIST TOE CHANGE UNDER AGGRESSIVE CORNERING LOADS. IT'S DESIGNED TO PROVIDE SURE, CONTROLLED HANDLING EVEN ON ROUGH PAVEMENT.





3.2CL5

ACURA

RCM 914

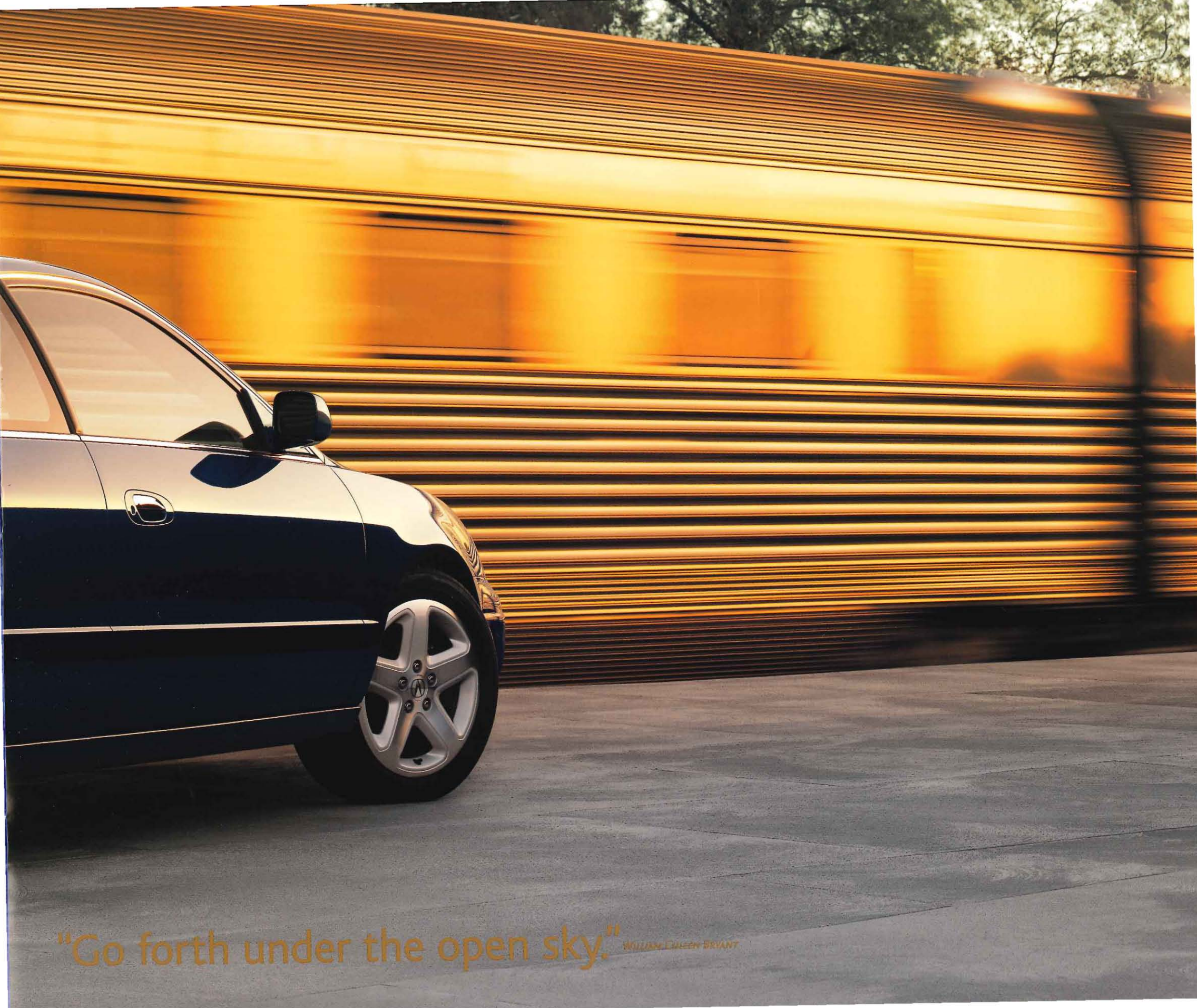

"Go forth under the open sky." WILLIAM EUGENE BRYANT



ACURA CL TYPE-S INTERIOR SHOWN WITH PERFORATED EBONY LEATHER AND AVAILABLE ACURA DVD-BASED SATELLITE-LINKED NAVIGATION SYSTEM.

ACURA NAVIGATION SYSTEM
GYRO SENSOR & GPS

MENU
MAP/GUIDE
A/C
CANCEL
IN ZOOM OUT

ANTI-THEFT ACURA NAVIGATION SYSTEM PUSH TO SELECT



REAR WIPER
WIPER
72
TEMP OFF AUTO

6-COMPACT DISC CHANGER

LOAD

CD 105 DISC TRACK

ACURA BOSE

AM FM CD TAPE

PLAY 1 PROG 2 REW FF 5 6

VOL PUSH PWR RPT / RDM SCAN / A SEL

ANTI THEFT

- TUNE + PUSH MODE SEEK / SKIP

POWER OUTLET



ACURA CL TYPE-S INTERIOR SHOWN WITH PERFORATED EBONY LEATHER AND AVAILABLE ACURA DVD-BASED SATELLITE-LINKED NAVIGATION SYSTEM.





SERIOUS DRIVING SHOULDN'T FEEL LIKE WORK.

For the driver intent on exploring this car's sporting capabilities to the fullest, the cabin of the Acura 3.2CL provides the perfect position of control. And when the pace takes a leisurely turn, the CL reveals itself to be an entirely comforting and accommodating luxury coupe.

Your first impression of the driver's seat confirms that it's ready for some fun, with generous side bolsters to hold you during spirited cornering. Yet the supple leather trim—perforated on the Type-S—conveys comfort for the long term. Use the 8-way power adjustment to tailor your seating position, then store it along with the side-mirror

positions in the two-driver memory system. You can even link your remote-entry transmitter to a unique memory setting, so the seat and mirrors adjust automatically when you unlock the doors with the remote. The driver's seat also features lumbar adjustment. The front passenger seat has 4-way power adjustment. And both are heated.

The thick, leather-wrapped steering wheel gives you a tactile hint of the enjoyment to be experienced. Every control feels precise and purposeful. Those of the Automatic Climate Control System, however, require minimal attention. Just set your desired conditions, and

they're achieved with amazing speed and precision. Or let the outside ambiance in with the power moonroof.

Other amenities include a rear-seat walk-in feature that powers the front seats all the way forward for easy entries and exits. A day/night rearview mirror that dims the glare from headlights automatically. An integrated HomeLink® system that allows you to operate up to three remote-control items. A sunglasses holder located in the overhead console next to the dual map lights. An armrest on the center console that adjusts fore and aft to match your preference. And many more conveniences to enjoy.



REAR CONSOLE WITH COMPARTMENT, ARMREST, DUAL BEVERAGE HOLDER AND TRUNK PASS-THROUGH
THE CONSOLE BETWEEN THE REAR BUCKET SEATS HAS A SPACIOUS, LOCKING COMPARTMENT INSIDE. FOLD THE CENTER ARMREST DOWN, AND A CONVENIENT PAIR OF BEVERAGE HOLDERS APPEARS. PLUS, THE LOCKABLE TRUNK PASS-THROUGH LETS YOU CARRY EXTRA-LONG CARGO SECURELY WITHIN THE CAR.



QUICK-READING INSTRUMENTS
THE LARGE ANALOG INSTRUMENTS IN THE CL CONVEY ENGINE AND ROAD SPEEDS, FUEL STATUS AND ENGINE TEMPERATURE AT A GLANCE. THE CL TYPE-S, AS SHOWN ON PAGE 12, FEATURES METALLIC-FACE GAUGES WITH BLACK NUMERALS. WHEN THE LIGHTS COME ON, THE NUMERALS TURN SCARLET ON A DARK BACKGROUND.



DUAL FRONT BEVERAGE HOLDERS
FROM COFFEE MUGS TO GIANT CONVENIENCE-STORE SODAS, THE DUAL BEVERAGE HOLDERS IN THE CENTER CONSOLE ARE DESIGNED TO CARRY THEM SECURELY. A FOLDING PANEL HIDES THE BEVERAGE HOLDERS WHEN THEY'RE NOT IN USE. AND THE CENTER CONSOLE ALSO FEATURES A PAIR OF STORAGE COMPARTMENTS AND AN ADDITIONAL 12-VOLT POWER OUTLET INSIDE.



STEERING WHEEL-MOUNTED CONTROLS
WITHOUT LIFTING A HAND FROM THE CL'S LEATHER-WRAPPED STEERING WHEEL, YOU CAN SET THE CRUISE CONTROL, INCREASE OR DECREASE YOUR SPEED, OR CANCEL IT ALTOGETHER WITHOUT TAPPING THE BRAKE. ON THE OTHER SIDE, AUDIO-SYSTEM CONTROLS LET YOU ADJUST THE VOLUME, CHANGE RADIO STATIONS, OR SELECT DIFFERENT TRACKS ON A CASSETTE TAPE OR CD.



ACURA CL TYPE-S SHOWN IN SATIN SILVER METALLIC.



GET LOST ONLY WHEN YOU WANT TO.

While getting the most out of driving your CL doesn't require a destination, you may occasionally need to get somewhere you've never been before. With the available Acura DVD-Based Satellite-Linked Navigation System,SM your CL can guide you with great precision to almost any address in the continental U.S. Along with easy-to-read map displays, the system can direct you with clear voice commands – so you can keep your eyes on the road.

The secret to this technologically advanced system lies in the three sources it uses in navigating: coordinates from geosynchronous global positioning system (GPS) satellites, a gyroscopic inertial-guidance system and motion data provided by a vehicle-speed sensor. The system combines this guidance information with route data for the continental U.S. – data stored on a single high-density DVD in the trunk. The result: one look at the bright, 6-inch, color touch-screen display, and you'll know where you are.

And you can easily travel to where you'd like to go. Using the touch-screen display or control buttons, just enter a destination and the system will calculate the most efficient route to take you there. Plus, it will provide estimates of the distance to your destination, the amount of time remaining before you arrive and the total elapsed time of your trip. The navigation system also offers convenient menus to help you find ATMs, service stations, airports, hotels or home addresses with ease. If you're in the mood for, say, some Mexican food, the navigation system can even provide you a list of nearby restaurants. Make your selection and the system will guide you, turn by turn, right to the restaurant's front door.

The navigation system is designed to be as versatile as it is powerful. If the traffic conditions block your way and you have to change course, the system can quickly recalculate a new route and have you on a guided detour in seconds. If you prefer to travel on surface streets, the system will provide a route that minimizes freeway driving. Even if you don't have the address of the restaurant or other point of interest you wish to visit, just enter its phone number and, if it's in the database, this remarkable system will find it for you.²

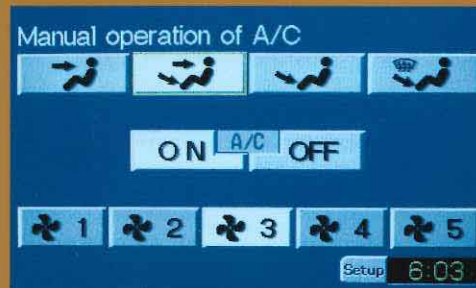
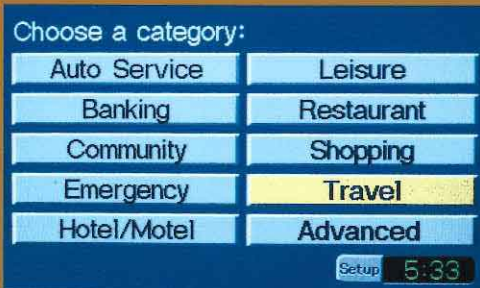

MULTIFUNCTION COLOR TOUCH-SCREEN DISPLAY
 THE NAVIGATION SYSTEM FEATURES CONVENIENT MENUS FOR A HOST OF DESTINATION SUGGESTIONS – SIMPLY TOUCH THE SCREEN, AND YOU'RE ON YOUR WAY. PLUS, WHILE VOICE COMMANDS GUIDE YOU EVERY STEP OF YOUR JOURNEY, A MOVING MAP DISPLAY UPDATES YOUR POSITION CONSTANTLY AS YOU TRAVEL. AND WHEN NOT NAVIGATING, THE TOUCH-SCREEN ALLOWS YOU TO OPERATE THE AIR-CONDITIONING SYSTEM MANUALLY.

THIS IS SOPHISTICATION YOU CAN HEAR.

It just wouldn't be fair to compare the Acura/Bose® Music System in the CL to even the most expensive audio systems you could buy for your home. Unless, of course, you have it installed and calibrated by an army of highly trained audio engineers.

Technicians from Bose and Acura have worked to create the perfect sound in a car audio system. They analyzed such factors as the location of occupants, the type of materials adorning the interior, and the angles, contours and volume of the CL's cabin. Armed with more than 1,000 measurements, they tailored the Acura/Bose Music System to the unique acoustic signature of the CL. The result surrounds you with lavishly rich audio reproduction, thanks to an array of six carefully placed Bose speakers. There's a 1.5-inch tweeter at the base of each windshield pillar, a 6.5-inch woofer in each door and two 6-by-9-inch coaxial woofer/tweeter speakers located in the shelf beneath the rear window.

Providing the source for these speakers is an advanced 3-in-1 head unit. It combines an AM/FM tuner with a cassette player and a 6-disc CD changer, all right before you in the dash. So if you want to enjoy hours of uninterrupted, digital-quality sound, you can slip a half dozen CDs into the changer from the comfort of your driver's seat.

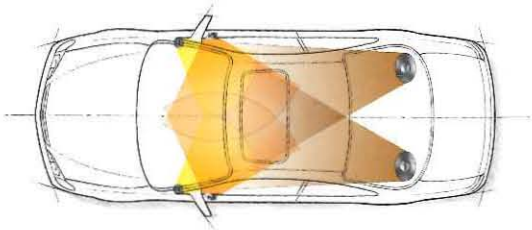

A ROLLING TRIBUTE TO THE SCIENCE OF SOUND
USING SOPHISTICATED MEASUREMENT DEVICES PLUS INPUT FROM SKILLED LISTENING EXPERTS, THE BOSE DESIGNERS LOCATED EACH SPEAKER TO PROVIDE THE OPTIMUM ACOUSTICS TO EACH PASSENGER.

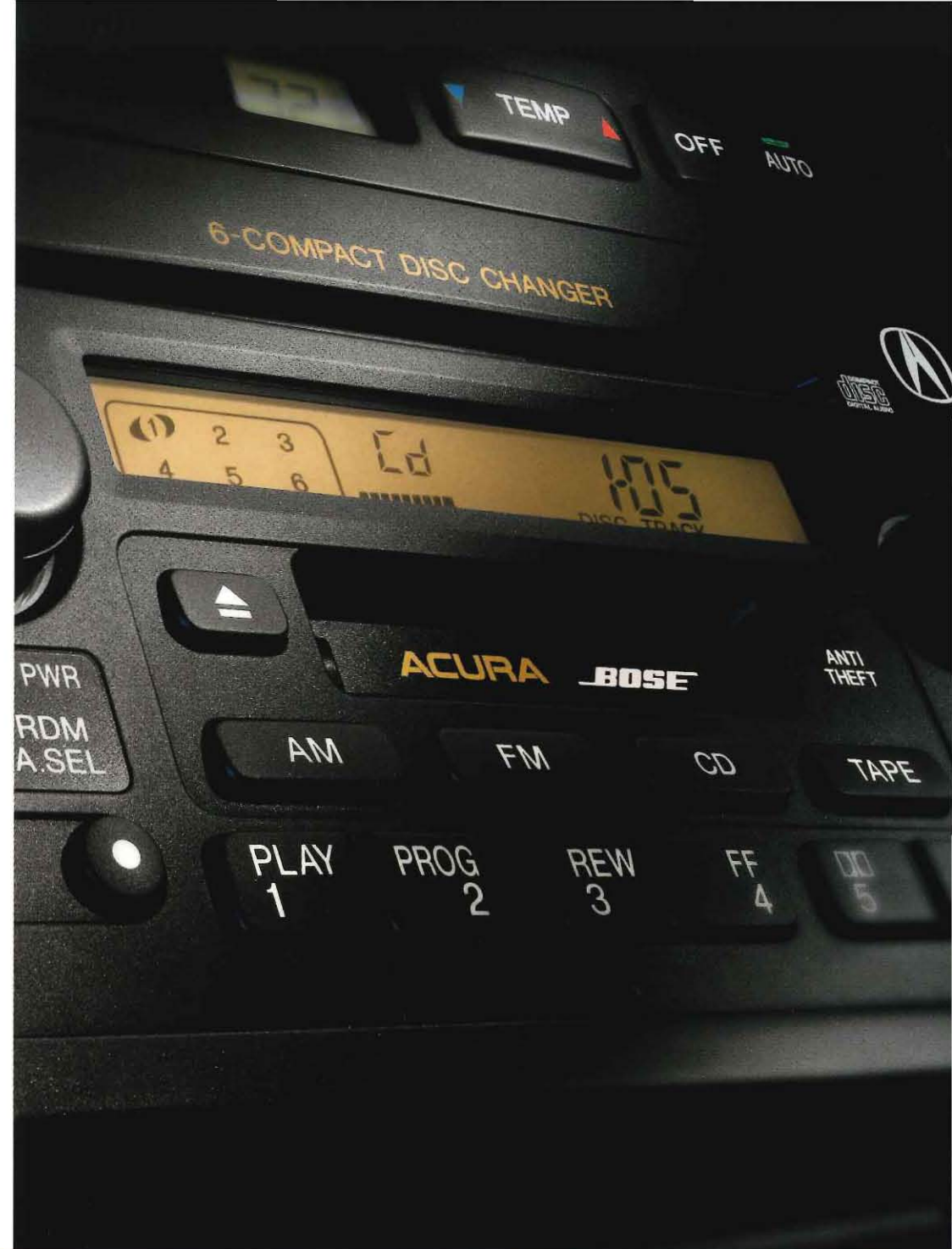

EXTRAORDINARY AUDIO AT YOUR FINGERTIPS

THE ACURA/BOSE MUSIC SYSTEM BRINGS YOUR FAVORITE AUDIO ENTERTAINMENT STUNNINGLY ALIVE. IN ADDITION TO A SEXTET OF BREATHTAKINGLY CLEAR BOSE SPEAKERS, THE SYSTEM PROVIDES YOU WITH AN ELECTRONICALLY TUNED AM/FM STEREO RECEIVER, A STATE-OF-THE-ART CASSETTE DECK AND A 6-DISC IN-DASH CD CHANGER. PLUS, THERE'S NO NEED TO LIFT A HAND FROM THE STEERING WHEEL OR TAKE YOUR EYES OFF OF THE ROAD WHEN YOU'RE CHANGING RADIO STATIONS, MAKING CD SELECTIONS OR ADJUSTING THE VOLUME, THANKS TO CONTROLS CONVENIENTLY MOUNTED WITHIN EASY REACH ON THE STEERING WHEEL.

TAKE TO THE ROAD WITH CONFIDENCE.

While the Acura 3.2CL is an extremely capable car, the world has a way of presenting unexpected challenges. So our engineers set out to create an impressive network of safety and security features to help assure that you can confidently enjoy the CL's performance.

The bedrock on which everything else depends is a steel-reinforced unit-body structure designed using the most advanced modeling and stress-analysis software. It was then subjected to real-life testing for verification and refinement. The result exhibits exceptional rigidity and strength to help absorb the forces of a possible impact before they can affect the passengers riding within. Front and rear crumple zones designed to deform progressively in an impact help to dissipate collision forces before they can intrude on the cabin.

To provide additional occupant protection, the CL comes with a standard dual front air bag supplemental restraint system (SRS)* and dual side-impact air bags. The dual-stage front passenger's air bag deploys at one of two

rates, depending on the severity of the collision and seat belt use, to help reduce the possibility of air-bag-related injuries. Occupant sensors in the front passenger's seat prevent the side air bag from deploying in the event a child or small-statured adult is out of position and leaning into the air bag's deployment path.

Myriad other safety systems enhance your feeling of security. The CL is equipped with seat-belt pretensioners that, in a collision, automatically tighten the front belts to help hold occupants in place. For additional side-impact protection, each door is reinforced with a pair of strong steel beams and offers impact-absorbing door-lining pads.

Of course, avoiding collisions is the first line of defense. So a standard Traction Control System (TCS) helps control drive-wheel spin. And the Vehicle Stability Assist (VSA) system on the Type-S helps counter skidding and plowing by braking individual wheels to help restore the car to its intended path.

*ACURA REMINDS YOU AND YOUR PASSENGERS TO FASTEN YOUR SEAT BELTS.

- A FRONT AND REAR CRUMPLE ZONES**
TO HELP DISSIPATE IMPACT FORCES BEFORE THEY CAN REACH THE PASSENGER CABIN, THE CL IS DESIGNED WITH FRONT AND REAR CRUMPLE ZONES THAT DEFORM PROGRESSIVELY IN THE EVENT OF A COLLISION.
- B STRONG UNIT-BODY CONSTRUCTION**
THE EXTREMELY RIGID UNIT-BODY STRUCTURE OF THE CL WAS DESIGNED USING SOPHISTICATED MODELING AND STRESS-ANALYSIS SOFTWARE, THEN TESTED RIGOROUSLY UNDER REAL-LIFE CONDITIONS.
- C DUAL SIDE-IMPACT DOOR BEAMS**
FOR ENHANCED PROTECTION IN THE EVENT OF AN IMPACT FROM THE SIDE, EACH OF THE DOORS IS FORTIFIED WITH A BEEFY PAIR OF HIGH-STRENGTH TUBULAR-STEEL BEAMS. PLUS, A SUBSTANTIAL CROSSMEMBER RUNS ACROSS THE FLOOR PAN FOR FURTHER REINFORCEMENT.
- D FRONT AND SIDE AIR BAGS**
THE CL'S STANDARD DUAL-STAGE FRONT PASSENGER'S AIR BAG USES SENSORS TO DETERMINE THE BAG'S INFLATION RATE. THE FRONT PASSENGER'S SIDE AIR BAG IS DESIGNED NOT TO DEPLOY IF A CHILD OR SMALL-STATURED ADULT IS LEANING INTO THE DEPLOYMENT PATH.
- E ANTI-LOCK BRAKING SYSTEM (ABS)**
A STANDARD 4-WHEEL ANTI-LOCK BRAKING SYSTEM (ABS) HELPS THE DRIVER RETAIN EFFECTIVE STEERING CONTROL DURING MAXIMUM-EFFORT STOPS.
- F STEEL-REINFORCED PASSENGER CABIN**
TO HELP PROTECT THE PASSENGER COMPARTMENT FROM IMPACT FORCES, THE ENTIRE CABIN IS SURROUNDED BY HIGH-STRENGTH STEEL REINFORCEMENTS.



HIGH-INTENSITY DISCHARGE HEADLIGHTS

FOR AN EXCEPTIONALLY CLEAR VIEW OF THE ROAD WHEN DRIVING AT NIGHT, THE CL IS EQUIPPED WITH STANDARD XENON HIGH-INTENSITY DISCHARGE (HID) LOW-BEAM HEADLIGHTS THAT PROVIDE A BRILLIANT BRIGHT LIGHT. THE XENON BULBS THROW A LONGER, WIDER BEAM.

SIDE AIR BAGS

TO COMPLEMENT ITS STANDARD DUAL FRONT AIR BAGS, THE CL ALSO FEATURES A SIDE AIR BAG IN EACH FRONT SEAT. OCCUPANT SENSORS IN THE FRONT PASSENGER'S SEAT PREVENT THE SIDE AIR BAG FROM DEPLOYING IF A CHILD OR SMALL-STATURED ADULT IS OUT OF POSITION AND LEANING INTO THE BAG'S DEPLOYMENT PATH.

TILT-DOWN OUTSIDE MIRROR

BACKING UP IS MADE A LOT EASIER WITH A STANDARD PASSENGER-SIDE POWER-TILT OUTSIDE MIRROR, WHICH OFFERS A BETTER VIEW BY AUTOMATICALLY TILTING DOWN WHENEVER THE DRIVER SELECTS REVERSE GEAR.

BUILT-IN CHILD-SEAT TETHER ANCHORS

FOR ENHANCED SECURITY AND PROPER POSITIONING WHEN USING A CHILD SEAT, THE REAR SEAT FEATURES STRONG, EASY-TO-USE CHILD-SEAT TETHER ANCHORS BOLTED DIRECTLY TO THE STRUCTURE OF THE CAR.



A

B

F

D

D

A

E

C

C

E

THE CLOSER YOU LOOK, THE BETTER IT APPEARS.

ENGINE

	CL	TYPE-S
Engine Type: Aluminum-Alloy	V-6	V-6
Displacement (liters)	3.2	3.2
Horsepower @ rpm (SAE net)	225 @ 5600	260 @ 6100
Torque (lbs-ft @ rpm)	216 @ 4700	232 @ 3500-5500
Valvetrain: 24-Valve, SOHC, VTEC™	•	•
Compression Ratio	9.8:1	10.5:1
Redline (rpm)	6300	6900
Fuel System: PGM-FI Multi-Point Injection	•	•
Ignition System	Electronic direct	Electronic direct
Emission System	LEV (ULEV in CA)	LEV

TRANSMISSION

5-Speed Automatic with Sequential SportShift™, Grade Logic Control and Lockup Torque Converter							
Gear	1ST	2ND	3RD	4TH	5TH	REVERSE	FINAL DRIVE
Ratio (:1)	2.563	1.551	1.021	0.653	0.470	1.846	4.428

CHASSIS

Body Type: Unit Body	•	•
Suspension: 4-Wheel Double-Wishbone/Multi-Link Rear	•	•
Stabilizer Bar (front/rear)	27.2 mm tubular/18.0 mm solid	27.2 mm tubular/19.0 mm solid
Steering: Variable Power-Assist Rack-and-Pinion	•	•
Turning Circle, Curb to Curb	37.4 ft	39.4 ft
Brakes: 4-Wheel Disc with ABS	•	•
Wheels	16" alloy	17" alloy
Tires	P205/60 R16 91V All-Season radials	P215/50 R17 93V All-Season radials

SAFETY FEATURES

CL TYPE-S

- • Driver's and front passenger's air bag supplemental restraint system (SRS)
- • Driver's and front passenger's side air bags with front passenger height and position sensors
- • Front passenger's dual-stage air bag
- • 3-point adjustable-height seat belts with load limiters and pretensioners (front)
- • 3-point seat belts at all seating positions
- • Heated door mirrors with reverse gear tilt-down feature
- • 4-wheel anti-lock braking system (ABS)
- • Vehicle Stability Assist (VSA) with traction control
- • Traction Control System (TCS)
- • Xenon High-Intensity Discharge (HID) headlights

CL TYPE-S

- • Impact-absorbing crumple zones (front and rear)
- • Dual side-impact door beams
- • Automatic day/night rearview mirror
- • Collapsible steering column
- • Impact-absorbing interior surfaces
- • Automatic transmission interlock feature
- • All-Season, steel-belted radial tires
- • Center high-mount brakeligh
- • All-around visibility: 301.8°
- • Rear window defroster with timer
- • Front side-window defoggers
- • Safety glass
- • Emergency trunk opener

INTERIOR FEATURES

CL TYPE-S

- • Leather-trimmed seats and door panels
- • Sport seats with perforated leather trim interior
- • Driver's 8-way power seat with 2-position memory system
- • Driver's seat adjustable lumbar support
- • Front passenger's 4-way power seat
- • Heated front seats
- • Leather-wrapped steering wheel and gear shift knob
- • Adjustable front-seat headrests
- • Power walk-in rear-seat access (both sides)
- • Simulated wood-grained console and door trim
- • Rear-seat headrests
- • Rear-seat center armrest with locking trunk pass-through and dual beverage holders
- • Front center console with adjustable armrest
- • Driver's and passenger's seatback pockets
- • Power moonroof with tilt feature and sliding shade
- • Acura/Bose® Music System with AM/FM stereo cassette and 6-disc in-dash CD changer
- • Acura DVD-Based Satellite-Linked Navigation System™ (available)
- • Theft-deterrent system with electronic immobilizer
- • Automatic Climate Control System with micron air-filtration system
- • Power windows and door locks
- • Steering wheel-mounted audio controls
- • Cruise-control system
- • HomeLink® system
- • Metallic sport gauges
- • Lighted trunk, ashtray, lower console, door switches, ignition switch and glove compartment
- • Tilt steering column
- • Sunglass holder
- • Dual overhead map lights
- • Remote trunk and fuel-filler-door releases
- • Speed-sensing, intermittent windshield wipers
- • Driver's and front passenger's illuminated vanity mirrors
- • Dual beverage holders (front and rear)
- • Digital quartz clock (without navigation)
- • Outside temperature gauge
- • Dual 12V power ports
- • Auto-off headlights

EXTERIOR FEATURES

CL Type-S

- Heated, power-operated, body-colored outside mirrors
- Heat-rejecting green-tinted glass
- Galvanized body panels
- Body-colored front and rear bumpers
- Printed radio antenna (rear glass)
- Dual-outlet exhaust
- Machined-finish alloy wheels

GENERAL SPECIFICATIONS

Recommended Fuel	Premium Unleaded 91 octane ⁵
EPA Estimated Fuel Mileage ⁶ (city/highway)	19/29
Fuel Tank Capacity	17.2 U.S. gallons (65 liters)
Crankcase Refill Capacity, including filter	4.6 U.S. quarts (4.4 liters)
Cooling System Capacity	7.8 U.S. quarts (7.4 liters)
EPA Passenger Volume	90.0 cu ft
EPA Estimated Cargo Volume	13.6 cu ft
Minimum Ground Clearance	6.2 in (158 mm)
Curb Weight (CL)	3470 lbs (1574 kg)
Curb Weight (CL Type-S)	3510 lbs (1592 kg)
Weight Distribution (% front/rear)	63/37
Headroom (front/rear)	37.5 in (953 mm)/36.7 in (933 mm)
Legroom (front/rear)	42.4 in (1078 mm)/33.0 in (837 mm)
Hiproom (front/rear)	52.9 in (1343 mm)/50.4 in (1281 mm)
Shoulder Room (front/rear)	56.4 in (1433 mm)/54.2 in (1377 mm)

SCHEMATICS

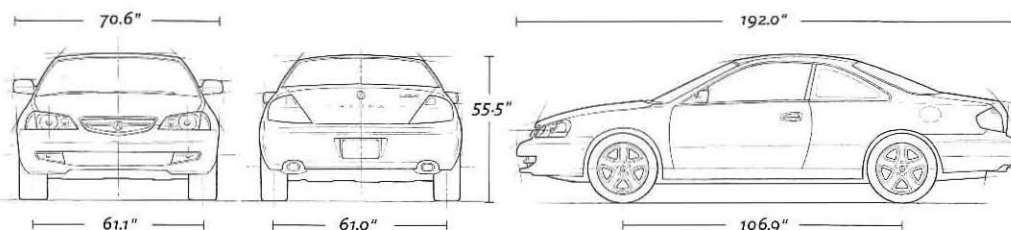

WARRANTY

Vehicle: 4-year/50,000-mile limited warranty³
Outer body rust-through: 5-year/unlimited-mile limited warranty³
Accessories: 4-year/50,000-mile limited warranty⁴
3.2-liter V-6 engine: No scheduled tune-ups required for 100,000 miles¹

©2001 ACURA DIVISION OF AMERICAN HONDA MOTOR CO., INC. ACURA, MDX, 3.5RL, TL, CL, RSX, NSX, ACURA DVD-BASED SATELLITE-LINKED NAVIGATION SYSTEM, SEQUENTIAL SPORTSHIFT, TOTAL LUXURY CARE (TLC), VSA, i-VTEC AND VTEC ARE TRADEMARKS OF HONDA MOTOR CO., LTD. SPECIFICATIONS, FEATURES, ILLUSTRATIONS AND EQUIPMENT SHOWN IN THIS CATALOG ARE BASED UPON THE LATEST AVAILABLE INFORMATION AT THE TIME OF PUBLICATION. ALTHOUGH DESCRIPTIONS ARE BELIEVED TO BE CORRECT, ACCURACY CANNOT BE GUARANTEED. AMERICAN HONDA MOTOR CO., INC., RESERVES THE RIGHT TO MAKE CHANGES AT ANY TIME, WITHOUT NOTICE OR OBLIGATION, IN COLORS, SPECIFICATIONS, ACCESSORIES, MATERIALS AND MODELS. SOME VEHICLES ARE SHOWN WITH OPTIONAL EQUIPMENT. HOMELINK® IS A REGISTERED TRADEMARK OF JOHNSON CONTROLS™ COVERED BY PATENT RIGHTS ISSUED AND/OR PENDING. ACURA RESERVES THE RIGHT TO LIMIT TLC SERVICES OR REIMBURSEMENTS TO ANY OWNER OR DRIVER WHEN, IN THE JUDGMENT OF ACURA, THE CLAIMS BECOME EXCESSIVE IN FREQUENCY OR TYPE OF OCCURRENCE. ACURA ALSO RESERVES THE RIGHT TO ALTER OR WITHDRAW THE ACURA ROADSIDE ASSISTANCE PROGRAM, OR ANY OTHER PART OF THE ACURA TLC PROGRAM, AT ANY TIME WITHOUT NOTICE. MAKE AN INTELLIGENT DECISION. FASTEN YOUR SEAT BELT.

¹ DOES NOT APPLY TO FLUID AND FILTER CHANGES OR PERIODIC INSPECTIONS. PLEASE REFER TO THE MAINTENANCE SECTION OF YOUR OWNER'S MANUAL TO DETERMINE ALL APPROPRIATE MAINTENANCE INTERVALS. ² SEE YOUR LOCAL ACURA DEALER OR THE VEHICLE'S NAVIGATION SYSTEM OWNER'S MANUAL FOR CURRENT NAVIGATION SYSTEM AREA COVERAGE. ³ ORDINARY MAINTENANCE ITEMS OR ADJUSTMENTS, PARTS SUBJECT TO NORMAL WEAR AND REPLACEMENT, AND CERTAIN OTHER ITEMS ARE EXCLUDED. SEE YOUR ACURA DEALER FOR THE TERMS AND CONDITIONS OF LIMITED WARRANTIES. ⁴ WHEN INSTALLED AT THE TIME OF NEW-VEHICLE DELIVERY. ⁵ GASOLINE WITH AN OCTANE NUMBER LOWER THAN 91 MAY BE USED, WITH REDUCED PERFORMANCE. ⁶ USE FOR COMPARISON PURPOSES ONLY. YOUR MILEAGE MAY VARY.

ACCESSORIES

WHETHER YOU CHOOSE THE CL MOONROOF VISOR, FULL NOSE MASK OR BURLWOOD SHIFT KNOB, EVERY CL ACCESSORY IS BUILT TO THE SAME UNCOMPROMISING ACURA STANDARDS.



ACCESSORY WHEELS

TO PUT YOUR PERSONAL SPIN ON YOUR NEW CL, THESE HANDSOME, MULTI-SPOKE CHROME-FINISHED WHEELS ARE AVAILABLE FROM YOUR ACURA DEALER. OR EQUIP YOUR CL WITH A SET OF OUR VERY SPORTY SPLIT-SPOKE CHROME ALLOY WHEELS.

GENUINE ACURA ACCESSORIES

UNDER-BODY SPOILER
ALL-SEASON FLOOR MATS (FRONT)
STEERING WHEEL WITH SIMULATED WOOD-GRAIN TRIM
SIMULATED WOOD-GRAIN METER TRIM PANEL
SIMULATED WOOD-GRAIN A/C VENT TRIM PANEL
CAR COVER
MAHOGANY SHIFT KNOB
GOLD EMBLEM KIT
ASHTRAY/CIGARETTE LIGHTER
ENGINE BLOCK HEATER
ACURA PROTECTION PACKAGE (INCLUDES SPLASH GUARDS, TRUNK TRAY AND WHEEL LOCKS)



REAR WING SPOILER

FOR THE FINISHING TOUCH ON YOUR CL'S DASHING GOOD LOOKS, YOUR ACURA DEALER CAN INSTALL AN AGGRESSIVE REAR WING SPOILER CUSTOM-DESIGNED TO INTEGRATE WITH THE REAR DECKLID.

SEE YOUR ACURA DEALER FOR A COMPLETE LIST OF ACCESSORIES.

TOTAL LUXURY CARE – OWNER BENEFITS.

Acura's commitment to your satisfaction doesn't end with delivery of a world-class automobile. It only begins there. We've developed a broad range of services designed to help you enjoy your new vehicle and provide assistance should you need it. First and foremost, every new Acura vehicle is covered by a 4-year/50,000-mile limited warranty.³ Every Acura also comes with Total Luxury Care™ (TLC), a collection of special services and privileges offered exclusively to Acura customers.

24-HOUR ROADSIDE ASSISTANCE

THIS SERVICE IS AVAILABLE EVERYWHERE IN THE CONTINENTAL UNITED STATES, DAY OR NIGHT, EVERY DAY OF THE YEAR. JUST CALL THE TOLL-FREE NUMBER AND ASSISTANCE IS ON ITS WAY.

24-HOUR TOWING

IF YOU ENCOUNTER A MECHANICAL PROBLEM, WE'LL SEND A TOW TRUCK AND BRING YOUR VEHICLE TO THE NEAREST ACURA DEALER OR QUALIFIED REPAIR FACILITY.

ACURA CONCIERGE – COMPLETE TRAVEL SERVICE

IF YOU NEED HELP PLANNING THE ROUTE OF A TRIP, OR NEED ASSISTANCE OR INFORMATION, ACURA CONCIERGE SERVICE IS READY TO LEND A HAND. IN AN EMERGENCY, ACURA CONCIERGE SERVICE CAN HELP YOU WITH MANY LOGISTICAL DETAILS, AND WILL EVEN RELAY UP TO THREE URGENT MESSAGES TO PEOPLE ON YOUR BEHALF.

TRIP-INTERRUPTION BENEFITS

TLC SERVICES INCLUDE TRIP-INTERRUPTION BENEFITS AND EXPENSE REIMBURSEMENT. IF A PROBLEM THAT IS COVERED BY YOUR WARRANTY INTERRUPTS YOUR TRIP MORE THAN 100 MILES FROM HOME, ACURA WILL REIMBURSE YOU. PLEASE ASK YOUR DEALER FOR ADDITIONAL PROGRAM DETAILS.

SPECIAL OWNER COMMUNICATIONS AND PRIVILEGES

ACURA WILL KEEP YOU UPDATED WITH PERIODIC OWNER-RELATED COMMUNICATIONS ON SPECIAL BENEFITS AND OWNER-APPRECIATION OFFERS AVAILABLE EXCLUSIVELY TO ACURA OWNERS.

ACURA.COM

VISIT OUR WEB SITE FOR THE LATEST INFORMATION, SPECIFICATIONS, PRICES, PHOTOS, SPECIAL OFFERS AND MORE. YOU CAN "DESIGN" YOUR OWN ACURA AND PERSONALIZE IT WITH GENUINE ACCESSORIES. PLUS, YOU CAN APPLY FOR FINANCING, CHECK OUT DEALER INVENTORIES AND OBTAIN A PRICE QUOTE THROUGH AN INTERNET-CERTIFIED ACURA DEALER BY CLICKING THROUGH TO eACURA.COM.

1-800-TO-ACURA

IF YOU'RE INTERESTED IN OBTAINING INFORMATION ON ACURA AUTOMOBILES, ACCESSORIES, PROGRAMS OR SERVICES, PLEASE CALL OUR TOLL-FREE NUMBER: 1-800-TO-ACURA. WE'RE THERE TO ASSIST YOU 24 HOURS A DAY, EVERY DAY OF THE YEAR.

ACURA CARE

ADDITIONAL PEACE OF MIND CAN BE ACQUIRED WITH THE ACURA CARE PROGRAM, WHICH PROVIDES COMPREHENSIVE VEHICLE AND TRAVEL PROTECTION BEYOND THE INITIAL WARRANTY PERIOD. PLEASE CONSULT YOUR LOCAL ACURA DEALER FOR A COMPLETE LIST OF THE FEATURES AND BENEFITS:



SEE YOUR LOCAL DEALER FOR DETAILS ABOUT THE PRIVILEGES OF OWNERSHIP, WHICH INCLUDE TOTAL LUXURY CARE (TLC), ACURA ROADSIDE ASSISTANCE AND CONCIERGE SERVICE.

CERTIFIED ACURA SERVICE



ACURA-TRAINED SERVICE PERSONNEL

YOUR ACURA DEALER APPRECIATES YOUR SELECTION. AT ACURA, WE BELIEVE THAT OUR COMMITMENT TO YOU BEGINS THE MOMENT YOU DRIVE AWAY WITH YOUR NEW ACURA AUTOMOBILE. WHICH IS WHY EVERY ACURA IS COVERED BY A FULL 4-YEAR/50,000-MILE LIMITED WARRANTY.³ AND SHOULD YOUR ACURA EVER REQUIRE SERVICE, REST ASSURED THAT THE TECHNICIANS AT YOUR ACURA DEALER HAVE BEEN TRAINED TO THE HIGHEST STANDARDS AND ARE THOROUGHLY FAMILIAR WITH EVERY FACET OF YOUR ACURA AUTOMOBILE. OUR GOAL IS SIMPLE: WE WANT TO ENSURE THAT YOU ENJOY YOUR ACURA NOW AND FOR MANY YEARS TO COME.

PRESENTING THE FULL LINE OF ACURA AUTOMOBILES.

RSX

ACURA'S WELL-ESTABLISHED REPUTATION FOR BUILDING EXCEPTIONAL SPORTS COUPES SHINES EVEN BRIGHTER NOW WITH THE INTRODUCTION OF THE SIZZLING NEW 160-HP RSX. AND THE EXTRA-SPICY 200-HP TYPE-S.



NSX

"EXOTIC" DOESN'T BEGIN TO DESCRIBE IT. THE HAND-BUILT ALL-ALUMINUM BODY, 290-HP VTEC ENGINE, RACE-BRED 4-WHEEL INDEPENDENT SUSPENSION AND AMENITY-RICH CABIN PUT NSX IN A CLASS OF ITS OWN.



MDX

DRIVERS SEEKING GENUINE SPORT-UTILITY CAPABILITY DON'T HAVE TO FORFEIT WHAT THEY LOVE MOST ABOUT PERFORMANCE CARS — SHEER DRIVING EXHILARATION. THE 240-HP MDX REINVENTS THE SUV EXPERIENCE.



3.2CL

STRIKING THE IDEAL BALANCE BETWEEN SCINTILLATING PERFORMANCE AND EXCEPTIONAL COMFORT, THIS LUXURY SPORT COUPE IS OFFERED IN TWO EXCITING FORMS: THE 225-HP CL AND THE 260-HP TYPE-S.



3.2TL

BORN OF OUR PROUD RACING HERITAGE, THIS IS THE PINNACLE OF SPORTS-SEDAN PERFORMANCE AND LUXURY. THE TL EXHILARATES WITH A 225-HP VTEC ENGINE. AND THE TYPE-S SCORCHES THE ROAD WITH A 260-HP BLAST.



3.5RL

AS THE FLAGSHIP EXPRESSION OF ACURA'S PASSION FOR EXCELLENCE, THE RL COMBINES AN AUTOBAHN-TESTED 225-HP ENGINE AND SUSPENSION SYSTEM WITH THE SOOTHING AMBIANCE OF LEATHER-AND-WOOD LUXURY.

IT'S NEVER AS SIMPLE AS BLACK AND WHITE.

Your Acura purchase is an investment—an investment in high quality and driving satisfaction. To ensure that the pride and enjoyment of owning your Acura remain as satisfying years from now as they are the day you take delivery, we envelop the precisely crafted bodywork in a hard, glass-smooth exterior finish that's every bit as durable as it is beautiful. And because you'll want to personalize your new Acura to suit your individual taste, we offer you an impressive selection of handsome exterior colors—each specifically chosen to enhance the timeless design of your Acura and carefully coordinated with fine interior materials in complementary hues.

CL	TYPE-S	EXTERIOR COLORS	INTERIOR COLORS
•	•	Taffeta White	Ebony*/Parchment
•	•	Satin Silver Metallic	Ebony
•	•	Naples Gold Metallic	Parchment
	•	San Marino Red	Ebony/Parchment
	•	Aegean Blue Pearl	Ebony
•		Eternal Blue Pearl	Ebony
•		Noble Green Metallic	Parchment
•	•	Nighthawk Black Pearl	Ebony/Parchment

*TYPE-S ONLY

EXTERIOR COLORS



TAFFETA WHITE



SATIN SILVER METALLIC

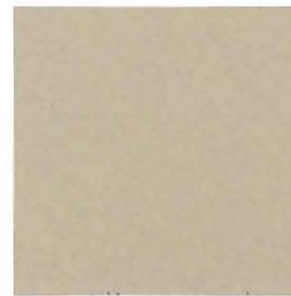

NAPLES GOLD METALLIC



SAN MARINO RED



AEGEAN BLUE PEARL



ETERNAL BLUE PEARL



NOBLE GREEN METALLIC



NIGHTHAWK BLACK PEARL

INTERIOR COLORS



PARCHMENT LEATHER

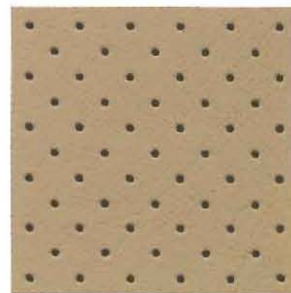

TYPE-S PARCHMENT LEATHER

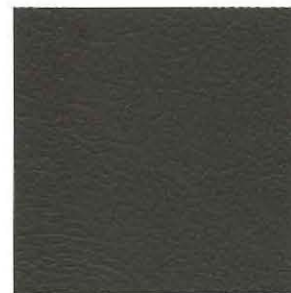

EBONY LEATHER



TYPE-S EBONY LEATHER

ACURA.COM

 ACURA