

2011 BMW
1 Series Convertible



128i
135i

The Ultimate
Driving Machine®



THE BMW 1 SERIES CONVERTIBLE.

LOWER THE ROOF. RAISE THE JOY.

BMW EfficientDynamics
Less emissions. More driving pleasure.



2011 BMW 1 Series Convertible

- 04119 Exterior
- 20123 Interior

Technology

- 24125 BMW EfficientDynamics
- 26129 Engine | Handling
- 30135 Safety
- 36137 BMW ConnectedDrive

Equipment

- 38141 Paints | Upholsteries | Interior trims | Combinations
- 42145 Selection examples
- 46157 Standard | Optional equipment
 - 58 BMW Accessories
 - 59 Safety illustrations
- 60163 Standard | Optional equipment charts
- 64165 Technical data
- 66167 BMW Services

The BMW 1 Series Convertible: an idea as pure and exhilarating as the night sky. A BMW that embraces the wind and tosses everything else conventional right back into it. Inspired by the legendary 2002, the 1 Series Convertible is the distillation of everything that makes a BMW The Ultimate Driving Machine.®
www.bmwusa.com



BMW 128i Convertible

128i Convertible shown with the following equipment:

- Engine: 230-hp, 3.0-liter inline six-cylinder
- Wheels: Star Spoke (Style 262) light alloy
- Exterior Options: Sport Package, Cold Weather Package, Xenon headlights, Park Distance Control, Moonlight Black softtop
- Exterior color: Cashmere Silver Metallic
- Upholstery: Taupe Boston Leather
- Interior trim: Gray Poplar Wood

For details on Standard and Optional equipment, please see pages 46-63.



**CONVERTIBLES ARE MADE FOR THE SUN.
 THIS ONE IS MADE FOR THE BILLIONS OF
 OTHER STARS TOO.**



**EVERYTHING BELOW YOU.
NOTHING ABOVE.**

Born to perform. Driven to please. The BMW 1 Series Convertible delivers the feeling of non-stop freedom every time you lower the top and hit the Start button. In the 135i, you'll outrace the wind as the 300-hp TwinPower Turbo engine with precise, piezo fuel injection propels you from 0-60 in 5.4 thrilling seconds.¹ In the 128i, the riveting 230-hp Valvetronic powerplant accelerates from 0-60 in a scant 6.4 seconds.² Both models are matched to superbly smooth-shifting manual or automatic transmissions. Handling is tight and agile; fade-resistant high-performance brakes quickly and confidently bring you to a full stop. Once you're ready to roll, the 1 Series Convertible rocks your senses.

¹ Manual transmission; 5.3 seconds, 7-speed Double Clutch Transmission. BMW AG test results. BMW urges you to obey all posted speed laws and always wear safety belts.

² Manual transmission; 7.0 seconds, STEPTRONIC automatic. BMW AG test results. BMW urges you to obey all posted speed laws and always wear safety belts.

YOU, THE ROAD, THE SKY. ONE.



From the sporty front air dam to the chrome-plated exhaust tips, this is one vehicle that easily attracts attention. A strong shoulder line, long hood, muscular wheel housings and short overhangs announce its proud performance heritage. This is further emphasized on the 135i by its Aerodynamic kit,¹ complete with rear apron and black chrome-plated exhaust tips. Whatever adventure you have in mind, the BMW 1 Series Convertible makes it happen – in style.

¹ See page 57 for details.

A LOOK THAT HEATS UP THE PAVEMENT.





**SUMMER IS NOT A SEASON.
IT IS A STATE OF MIND.**

No matter which latitude you call home, the lure of the wind in your hair and the road ahead is universal. So whenever you're ready for true ultimate driving freedom, so is the 1 Series Convertible. In just 22 seconds, its fully automatic softtop folds and stows. However, the unique, Moonlight Black softtop¹ is so stunning, you just might be tempted to leave it up.

¹ Softtop available in Black (standard), Taupe (no-cost option), or Moonlight Black (optional).

HOW TO TURN NIGHT INTO DAY.

The 1 Series Convertible shines at night. The dramatic Corona headlight-rings that function as both parking lights and Daytime Running Lights¹ are pure BMW. They circle the Xenon Adaptive Headlights, which illuminate the street ahead and to the side with daytime-like clarity, and swivel to show what's around the corner as you turn.² Flick the turn signal left or right, and Cornering Lights flood a large swath of ground in that direction, revealing previously unseen obstacles and pedestrians.² And when sensors detect fading ambient light, BMW's Automatic headlight control function automatically turns the headlights on. From the rear, the 1 Series Convertible is equally arresting – the bright LED taillight clusters and brake display are intensified during emergency stops, immediately warning those behind you to brake.

¹ Daytime Running Lights can be activated at your BMW center.

² Xenon Adaptive Headlights and Cornering Lights standard on the 135i, optional on the 128i.



SO INTELLIGENT, IT CONTROLS THE CLIMATE EVEN WHEN THE TOP IS DOWN.

In the 1 Series Convertible, even when the outside temperature is less than perfect, you'd never know it. Like its Coupe sibling, the 1 Series Convertible's climate-control system has three standard ventilation modes: gentle, medium and intense. These react primarily to interior temperature sensors. However, an additional "convertible mode" reacts not just to the interior temperature, but to the exterior as well, when the top is down. It even takes into account the strength of the sunlight and your driving speed to precisely determine the best ventilation setting. So whether the outside air is blistering or chilling, the cabin remains remarkably comfortable all the time.



BMW PRECISION: THE LOGICAL SIDE OF PASSION.

Born of sharp, precise and innovative minds, the 1 Series Convertible features some of BMW's greatest engineering feats. Near-perfect 50/50 weight distribution and rear-wheel drive ensure sporty handling. The suspension – a stiff yet lightweight aluminum double-pivot front; five-link fully independent rear – is sport-tuned for amazing responsiveness. Dynamic Stability Control (DSC) ensures precise handling and stability in less-than-optimal conditions. Active Steering, an innovative option available in the 135i, automatically changes the steering ratio based on vehicle speed, for steering that's more stable at higher speeds, and more immediate at lower speeds. It's advanced engineering like this that keeps the BMW 1 Series Convertible well ahead of the curve.

For details on the availability of standard and optional features, please refer to the Standard equipment | Optional equipment charts at the back of this brochure.



**THE 1 SERIES CONVERTIBLE:
A GREAT WAY TO STAY OPEN TO FRESH IDEAS.**





WHO SAYS PRACTICALITY CAN'T BE STUNNING?

The 1 Series Convertible's inviting cabin lifts your spirits. Inside, pearl gloss-accented gauges and controls are intuitively placed within easy sight and reach. You can access frequently used audio selections, addresses and – when equipped with compatible Bluetooth® wireless communication – phone numbers by using the six programmable memory keys in the center console. Imagine plugging your MP3 player into the auxiliary input, then cruising your favorite roads with the top down while listening to great sounds through the on-board speakers. Use the iPod® and USB adapter to access your favorite songs, playlists – even your iPhone® – using the multi-function sport steering wheel. You'll hear subtle nuances through the Harman Kardon Surround Sound speakers. And wherever you go, take HD Radio™ and SIRIUS Satellite Radio along for crystal-clear reception.

For details on the availability of standard and optional features, please refer to the Standard equipment | Optional equipment charts at the back of this brochure.



**WHERE THE LINES ON THE ROAD
MEET THE RAYS OF THE SUN.**

Put the top down and let the sun shine. BMW's unique Sun-Reflective Technology deflects the sun's infrared rays, leaving the Boston Leather surfaces cooler to the touch – even in direct sunlight. Choose from five upholstery colors and four attractive trims – Glacier Silver Aluminum, Gray Poplar Wood, Light Burl Walnut Wood and High-Gloss Black. Strap yourself into the eight-way adjustable front seats with two-way headrests. Four-way power lumbar support adds customized comfort; with the Sport Package or M Sport Package, highly bolstered sport seats hold you tight in curves. BMW makes it easy to stow your gear; the trunk offers a generous amount of storage space for a convertible this size. It holds two golf bags with the softtop down; top-up, there is even more room. With the through-loading system, an integrated ski bag can be extended from the trunk into the rear cabin, letting you load and protect long cargo.

For details on the availability of standard and optional features, please refer to the Standard equipment | Optional equipment charts at the back of this brochure.

THIS IS HOW MUCH HAS GONE IN.

At BMW, we create dynamic vehicles that thrill you with quick acceleration, predictable handling and unshakable control. We are also busy finding innovative fuels and technologies that help preserve the environment while delivering legendary performance. This is what we refer to as "EfficientDynamics." This goal led to the visionary CleanEnergy hydrogen-powered engine in the BMW Hydrogen 7 Sedan. In 2009, BMW introduced Advanced Diesel with BluePerformance in the U.S., offering diesel power with quick acceleration, increased fuel efficiency and reduced emissions. And now, BMW's ActiveHybrid X6 and ActiveHybrid 7 vehicles combine combustion and electric power to boost performance while simultaneously reducing fuel consumption and CO₂ emissions. At BMW, we are driven to do much more with less.

Double-VANOS

VANOS is BMW's valve timing system that can "steplessly" vary the points in the combustion cycle when valves open and close. Double-VANOS refers to the fact that it operates on both the intake and exhaust camshafts. Electronically controlled in response to engine speed, load and temperature, VANOS reduces emissions, and enhances low- to medium-speed torque, as well as fuel efficiency.

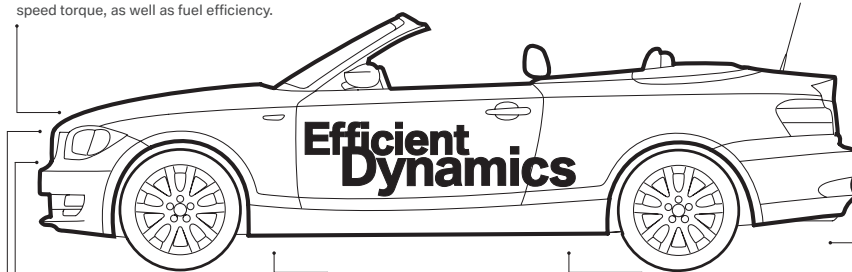

Valvetronic

Instead of using a traditional throttle, Valvetronic technology in the 128i lets the engine breathe more easily by varying the lift height of the valves to regulate air intake. The result: improved cold starts, smoother running, and a significant drop in fuel consumption. Using revolutionary technology such as this, BMW has improved its overall average fuel economy more than any other manufacturer.

TwinPower Turbocharged engine

Benefiting from BMW's TwinPower Turbocharging technology, the 300-hp 135i delivers quick acceleration without any "turbo lag." Fuel economy is strong, as well, thanks to precise piezo direct fuel injection.

Efficient transmissions

The 1 Series Convertible offers a choice of transmissions, each designed to maximize efficiency. In both models, a smooth-shifting 6-speed manual is standard. Automatic transmissions are also available: a 6-speed STEPTRONIC automatic in the 128i, and in the 135i, a quick-shifting 7-speed Double Clutch Transmission.

Lightweight construction

Our engineers use lightweight aluminum throughout our vehicles – in the front section, for example, or for the suspension. BMW's inline six-cylinder TwinPower Turbo engine is all aluminum; the naturally aspirated inline six is an aluminum/magnesium composite – the lightest in its class. Taken together, these weight savings lead to lower fuel consumption and better axle load distribution for more agility – especially in curves.

AND THIS IS WHAT COMES OUT.

BMW models have low CO₂ emissions today. But that's just for starters. We're carrying on our research in the quest to bring you greater driving pleasure, with fewer emissions and decreased fuel consumption.

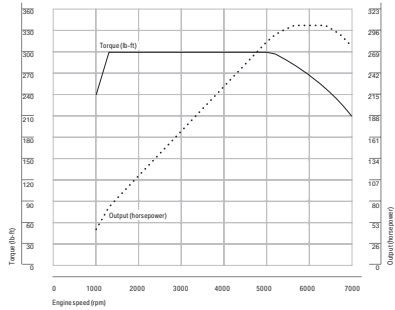

Portrait of an engineering masterpiece: The 135i TwinPower Turbo engine produces 300 hp at 5800 rpm, and quickly develops 300 lb-ft of torque at just 1200 rpm, which continues, without fading, to the 5000 rpm range. With such a broad range of powerful torque, you can enjoy smooth, robust acceleration in any gear, at any speed.

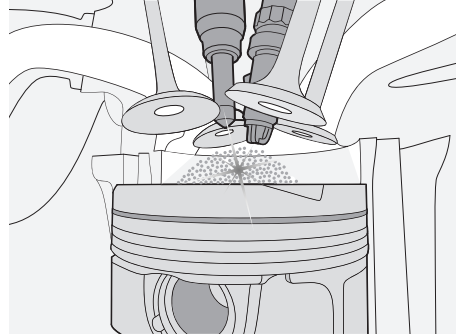

High Precision Injection: Piezo injectors positioned close to the spark plugs in the 135i ensure lean-burn operation under partial loads. To provide optimum combustion, the fuel is injected at high pressure into the cylinders, up to 200 times per fraction of a second. This means that only part of the combustion chamber is filled with an ignitable fuel/air mixture, so fuel is used extremely efficiently.

MOVING ENGINE TECHNOLOGY TOWARD THE FUTURE.

BMW engines have been winning accolades from the press for years. Beneath the long hoods of the 128i and 135i Convertibles lie two of the world's most sophisticated 3.0-liter inline six-cylinder powerplants. Lightweight engine blocks, as well as Double-VANOS and Valvetronic technology enhance their smooth power delivery, fuel efficiency and lowered emissions. Advanced Valvetronic technology lets the engines "breathe" better, for greater power, higher torque, quicker response, a smoother idle and enhanced efficiency.

For its bravura performance, the 135i for 2011 draws upon BMW's new TwinPower Turbo – the first engine in the world to combine turbocharging, High Precision Injection, and Valvetronic technology. This twin-scroll wonder develops 300 lb-ft of torque at just 1200 rpm and continues all the way to 5000 rpm. It's a force that throws you back in your seat right from the start and doesn't let up. With 300 horses on tap, the 135i can sprint from 0 to 60 mph in 5.3 seconds,¹ and has an electronically limited top speed of 130 mph. Thanks to BMW's award-winning engine expertise, turbo lag is a thing of the past. By using a high-precision piezo fuel-injection system, every ounce of fuel is maximized for greater efficiency, while CO₂ emissions are reduced.

The naturally aspirated, 230-hp inline six in the 128i is capable of producing 200 lb-ft of torque at 2750 rpm, for power that pours on early and strong and continues throughout the powerband. Hit the accelerator and you're sailing past 60 mph in 6.4 seconds.² The lightweight composite magnesium/aluminum engine block adds to the 128i's spirited acceleration and nimble handling.

Both models offer, as standard, a silky-shifting 6-speed manual. The 135i can also be ordered with 7-speed Double Clutch Transmission (DCT) for lightning-quick shifts; in the 128i, STEPTRONIC automatic with Adaptive Transmission Control is available. When either model is equipped with the optional transmission – and, in the 128i, either the Sport Package or M Sport Package – steering wheel-mounted paddle shifters are automatically added. But whichever engine and transmission combination you choose, innovative BMW engineering makes it possible to enjoy outstanding power and performance with reduced emissions and fewer trips to the pump.

¹ 7-speed Double Clutch Transmission; 5.4 seconds, manual. BMW AG test results. BMW urges you to obey all posted speed laws and always wear safety belts.

² Manual transmission; 7.0 seconds, STEPTRONIC automatic. BMW AG test results. BMW urges you to obey all posted speed laws and always wear safety belts.



Twin-scroll turbo technology provides instantaneous power development in the BMW 135i.



TRANSLATING POWER INTO PERFORMANCE.

BMW engineered the 1 Series Convertible's lightweight chassis to perfectly harmonize with the engine and transmission. As soon as you start driving, you're aware of how well it reacts to the road – with precise steering, agile handling and lack of vibration and noise.

Further enhancing the quality of the driving experience, BMW offers Active Steering on the 135i – an innovative option that adapts the steering ratio and front-wheel turn-angle to suit the vehicle's speed. At low speeds, it takes just two turns of the steering wheel to move the front wheels from far left to far right. Navigating the “twisties” and tight areas becomes a breeze. As the vehicle speed increases, the steering ratio gradually changes; at highway speeds, you enjoy greater directional stability and more comfortable cruising.

Active Steering also includes yaw compensation, an “active safety” benefit that helps to keep the vehicle going straight while braking on surfaces where each wheel has varying levels of grip. For example, if the car begins to swerve while braking, Active Steering compensates by means of automatic, subtle steering adjustments.

When you combine the benefits of Active Steering with the 1 Series Convertible's powerful acceleration, responsive handling and excellent road holding, it adds up to an intensely enjoyable driving experience.

For details on the availability of standard and optional features, please refer to the Standard equipment | Optional equipment charts at the back of this brochure.

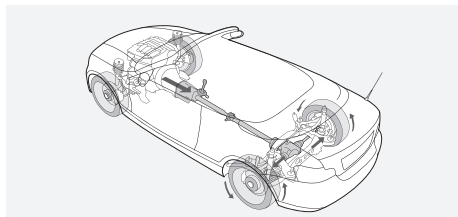

Rear-wheel drive: The hallmark BMW rear-wheel-drive configuration gives the 1 Series Convertible its athletic agility, while helping to maintain an even weight distribution across the entire drive system. The result is optimized traction and transfer of power to the road.

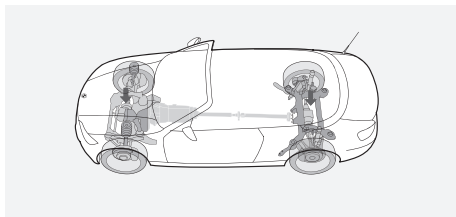

Near-perfect 50/50 weight distribution: The front and rear axles each carry almost exactly half of the car's weight. Balanced weight gives the 1 Series Convertible neutral steering and outstanding directional stability. And with a sport-tuned suspension and DSC provided as standard, it remains stable in virtually all road conditions.

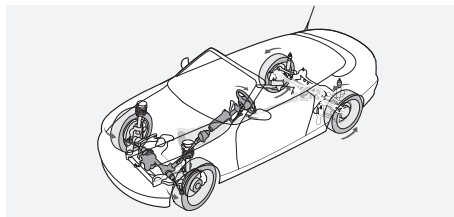

Steering: Torque steer is eliminated because steering and propulsion are not handled by the same pair of wheels. Steering force is evenly distributed; steering does not become harder; and steering-wheel angles are small. An added benefit: increased cornering speed.

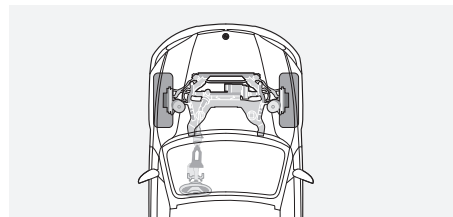

Aluminum front suspension: The 1 Series Convertible uses a lightweight, twin-joint tension strut suspension for maximum strength and minimum weight; hydro-mounts reduce vibration and noise. The overall result is noticeably athletic agility and responsive steering.



BMW'S MANY INNOVATIVE IDEAS HELP YOU MAINTAIN CONTROL.

BMW firmly believes that powerful brakes are just as important as a powerful engine. That's why the 1 Series is equipped with four large ventilated anti-lock disc brakes, as well as BMW's Dynamic Stability Control (DSC) system. DSC monitors wheelspin to help keep the vehicle under control and headed in your intended direction. If your BMW begins to slide, DSC intervenes by reducing engine power and braking each wheel individually and independently, to help your BMW regain its footing. For sportier driving or in deep snow, Dynamic Traction Control (DTC) allows increased wheelslip. In the 135i, DSC is designed specifically for performance-oriented driving. The accelerator pedal has a quicker response rate, and the rear brakes simulate a differential lock electronically for stronger acceleration in turns.

In both models, DSC also includes four additional features. When a sensor detects that it is raining, **Brake Drying** helps eliminate accumulated moisture by bringing the brake pads into contact with the rotors to dry them. If you suddenly remove your foot from the throttle, **Brake Stand-by** anticipates you want to stop quickly, and pre-tenses the brake calipers for faster action when you apply the brakes. When descending steep roads, brakes can heat up from continuous and repeated braking; this reduces braking power. **Brake Fade Compensation** senses and compensates for this by applying the brakes with more force, while using the same pedal pressure. And **Start-off Assistant** helps prevent your car from rolling forwards or backwards when stopped on a hill, holding it momentarily as you release the brake to start moving again.

Xenon Adaptive Headlights also assist you in curves. The Adaptive Headlights feature automatically swivels the lights to follow the curves of the road, using data from on-board sensors and the steering wheel angle to determine the vehicle's direction. Xenon headlights illuminate the road ahead with near-daylight brilliance and clarity; an auto-leveling feature helps keep headlight glare out of the eyes of oncoming drivers. Cornering Lights, which are included with this feature, illuminate the side of the road up to 90 degrees when making turns.

For details on the availability of standard and optional features, please refer to the **Standard equipment** | **Optional equipment** charts at the back of this brochure.

SAFETY IS ALWAYS #1 IN THE 1 SERIES.

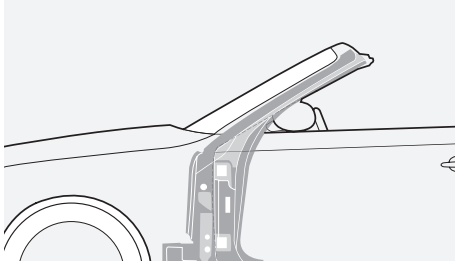

In the passenger compartment, the strengthened frame around the A-pillars and windshield acts as a rollover bar.

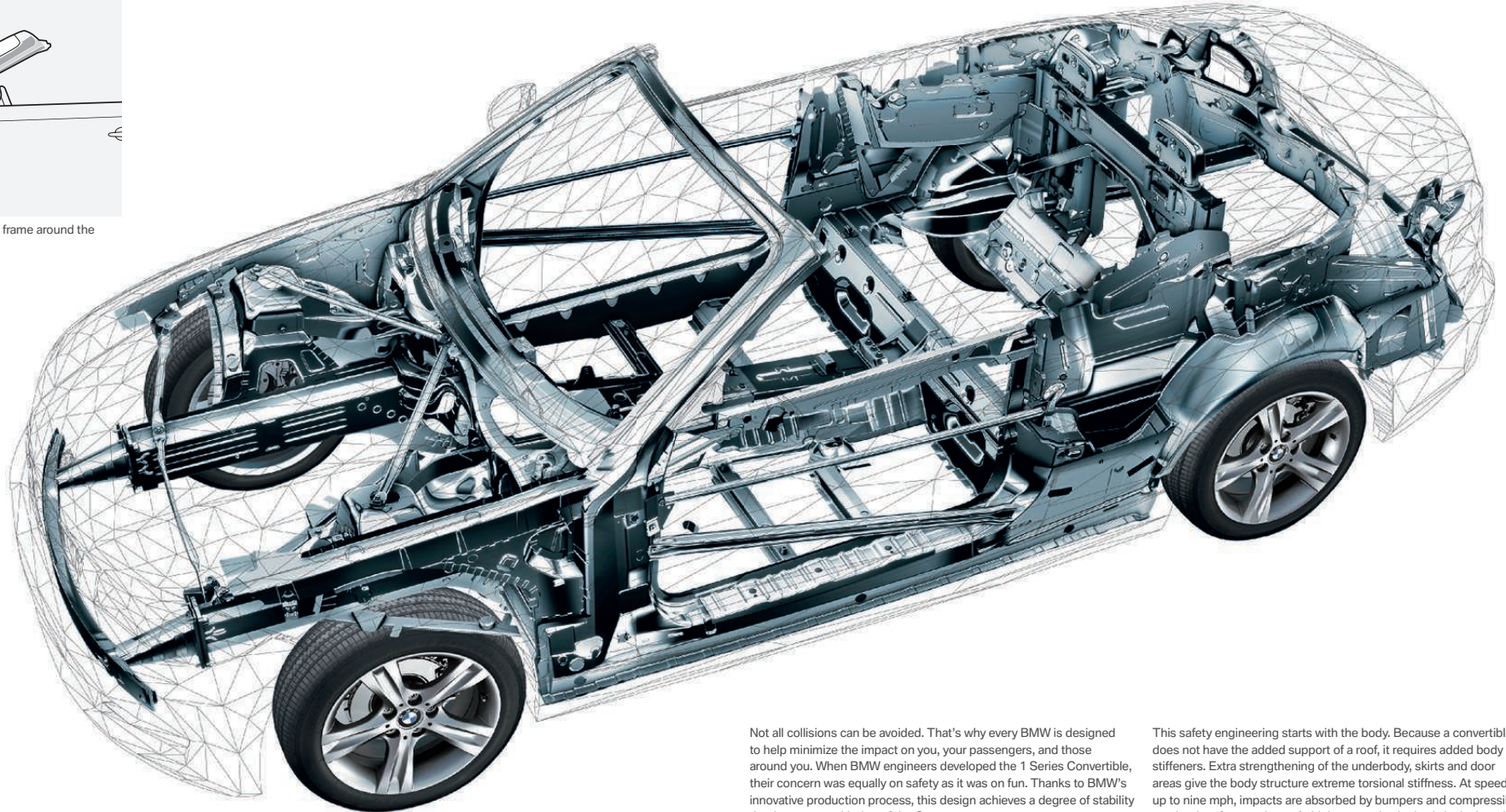

Not all collisions can be avoided. That's why every BMW is designed to help minimize the impact on you, your passengers, and those around you. When BMW engineers developed the 1 Series Convertible, their concern was equally on safety as it was on fun. Thanks to BMW's innovative production process, this design achieves a degree of stability that is on a par with that of the Coupe.

This safety engineering starts with the body. Because a convertible does not have the added support of a roof, it requires added body stiffeners. Extra strengthening of the underbody, skirts and door areas give the body structure extreme torsional stiffness. At speeds up to nine mph, impacts are absorbed by bumpers and compressible crush tubes front and rear. At higher speeds, the body is designed to deform in a predetermined pattern, routing impact energy around the passenger cell. At the front, the strengthened windshield, featuring reinforcements in the front A-pillars and cowl top panel, acts as an integrated rollover bar.

EVEN WITH THE TOP DOWN, BMW HAS YOU COVERED.

The 1 Series Convertible is equipped with BMW's Advanced Safety System. Its highly accurate sensors react immediately to parameters such as vehicle angle, longitudinal and lateral acceleration, or loss of ground contact. This data is evaluated by high-speed electronic processors, which can then determine the best deployment strategy for the many safety restraints throughout the vehicle. These include airbags and rollover bars that spring up from behind the rear-seat headrests. Even the pedals move away from the driver's feet in a frontal collision, for optimum protection. Together with the reinforced windshield, door reinforcing bars and the remarkably strong body, they combine to form a reassuring occupant safety zone.

In addition to large-volume frontal airbags, the 1 Series Convertible has side-impact airbags integrated into the front seats. These are designed to help protect both the head and thorax of the driver and front passenger. In case of a severe collision, the Battery Safety Terminal disconnects the starter cable from the battery in milliseconds, reducing the risk of an electrical fire. Headlights flash, interior lights come on and the doors automatically unlock to assist emergency aid, as well. Additionally, 1 Series models equipped with optional BMW Assist^{TM1} will automatically transmit their location to a response specialist, who will coordinate any needed emergency help, for your added peace of mind.

¹ For details on BMW Assist Safety and Convenience Services, visit bmwassist.com.

The three-point seat-integrated safety belt system offers excellent protection, with optimum belt geometry at all four seats.



In a side impact, large seat-integrated side airbags are designed to help protect the upper body and head.



Rollover bars are integrated behind the rear headrests, but they are invisible under normal conditions.



In the event of a rollover, sensors ensure that the rollover bars are deployed within fractions of a second.

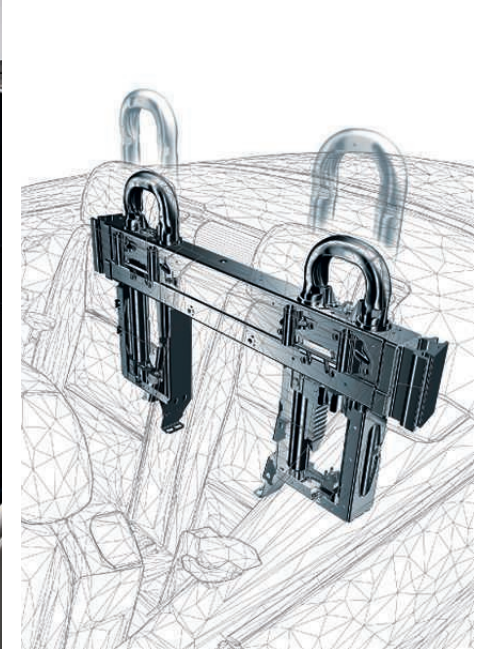

STAY TOTALLY IN TOUCH WHEREVER YOU GO – WITH BMW CONNECTED DRIVE.

Whether you're far from home or just in the next town, BMW Assist™ offers convenience and peace of mind. There are new ConnectedDrive features that extend BMW's leadership in wireless communications. Marvel at an extensive array of new Mobile Office functions. Get a visual image of your callers. With BMW Assist, you enjoy all this – and more.



With **BMW Assist Safety Plan**, a response specialist is there to help you 24/7 at the touch of a button. Enjoy these services for four years at no additional charge: Automatic Collision Notification, Emergency Request (SOS), TeleService, Enhanced Roadside Assistance, Door Unlock, Stolen Vehicle Recovery, MyInfo and Customer Relations. The **Convenience Plan** adds personalized Directions, Traffic and Weather reports, BMW Search, and Concierge services for restaurant and hotel recommendations, with the destination address and phone number sent to your BMW. Make up to four operator-assisted calls per year with Critical Calling if your mobile phone is not available or if its battery is discharged.

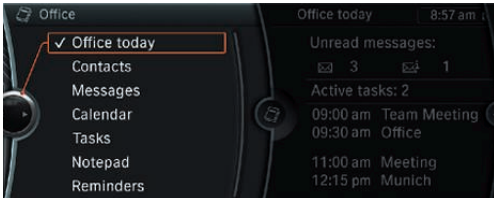

An automotive first: BMW's amazing new **Mobile Office** feature goes way beyond phone calls when it comes to staying in touch. When your compatible Bluetooth® phone is paired with your BMW, text messages and emails are transferred to your BMW's iDrive display screen – and then our system even reads them aloud to you.

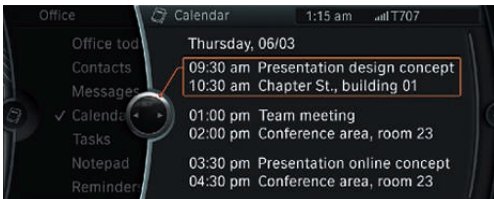

What's on today's agenda? Bring up the **Calendar** and **To-do List** on your display screen while en route, to help you stay on schedule. Need to call your 11 o'clock appointment? Use the iDrive Controller knob to **click on the phone number** in the Calendar – and it's ringing. Meeting with several people? Conduct conference calls; the display screen keeps you informed of the status of incoming calls. Who's calling you? If you've uploaded photos to your on-board phonebook, you'll see the caller's picture. Even missed calls are listed on the display screen. It's never been easier to stay in touch while in transit.



Enhanced functions for the iPod® and USB adapter add to the ease and pleasure of using your iPod or iPhone®. Want to know which CD that song comes from? The album cover is shown on your display screen. Don't purchase additional cables – your iPod or iPhone's original USB cable connects to your BMW's USB port. Another rare feature: with BMW Assist and Bluetooth audio streaming, you can wirelessly play music through the BMW audio system from any Bluetooth compatible music player or mobile phone, from anywhere in your vehicle. In fact, the audio library appears on the display screen, where you can use the iDrive Controller knob to make your selection.



"Whenever I'm far from home, I have peace of mind knowing that BMW Assist is right there, ready to help me should I need it."



MyInfo allows you to send business locations and street addresses to your BMW from Google Maps™. Destinations and phone numbers can be accessed and exported to your Navigation system for immediate route guidance, while you can call the destination with your Bluetooth linked phone.

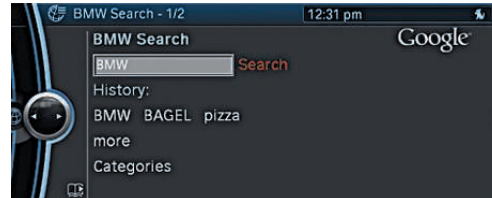

BMW Search allows online access to up-to-date fuel prices and gas station locations; the latest weather forecasts, advisories and warnings; Dow Jones, S&P 500 and NASDAQ indices; and the powerful reach of the Google Maps database – all delivered on the control display inside your vehicle. Access news headlines and have them read aloud via text-to-speech technology. "Send to Mail" pinpoints your current location and planned destination, and allows you to send it to any smartphone or email account. Then it's just a quick hyperlink to Google Maps for your friends and family to see where you are and where you're going.

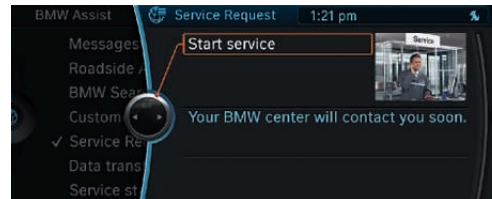

BMW TeleService monitors the status of many of your vehicle's fluids and parts that are subject to wear and tear, and automatically transmits the data to your BMW center before it requires service. Your BMW center will contact you to schedule a convenient appointment. Needed parts will be ordered, so your BMW will be serviced and returned to you as quickly as possible.



Want to know the location of a challenging golf course or a fine French restaurant? Talk to our **Concierge** and get the address and phone number of your desired destination sent to your BMW Navigation system and then start route guidance at the push of a button.

The pages in this section show available colors and materials for the BMW 1 Series Convertible. Use these samples to compare paint, upholstery, trim colors and combinations. Please note that these samples are representations; they are not exact reproductions. To see the actual colors, visit your local BMW center. They will be happy to show you original samples and assist you with special requests.

Exterior colors

■ 300 Alpine White Non-metallic

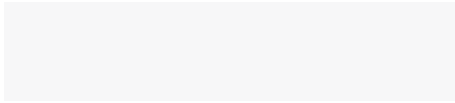

■ A61 Crimson Red Non-metallic¹



■ 668 Jet Black Non-metallic¹



□ 354 Titanium Silver Metallic



□ A72 Cashmere Silver Metallic¹

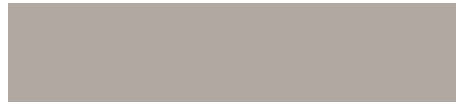

□ A52 Space Gray Metallic



□ A76 Deep Sea Blue Metallic¹



□ A51 Montego Blue Metallic¹



□ 381 Le Mans Blue Metallic²



□ 896 Blue Water Metallic¹



□ 475 Black Sapphire Metallic

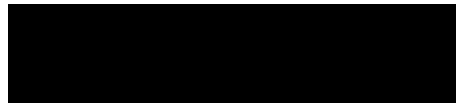

Upholstery colors

■ KAA5 Taupe Leatherette

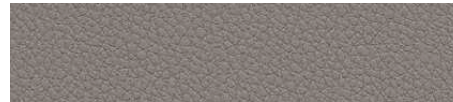

■ KASW Black Leatherette

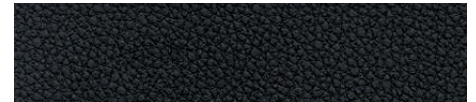

□ LWB4 Savanna Beige/Black Boston Leather



□ LWA5 Taupe Boston Leather

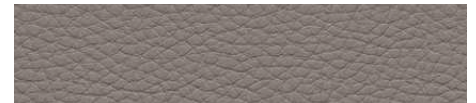

□ LWAL Gray/Black Boston Leather



□ LWD1 Coral Red/Black Boston Leather

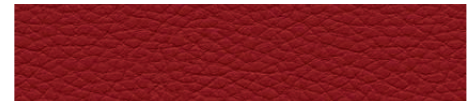

□ LWSW Black Boston Leather

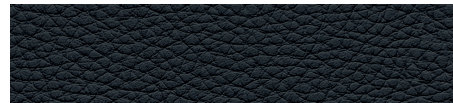

Leather upholstery with Sun-Reflective Technology covers the fronts of all seats and headrests.

¹ Not Available with M Sport Package.
² Requires M Sport Package.

Softtop colors

■ 388 Black



▲ 394 Taupe (Not available with Savanna Beige/Black Boston Leather.)

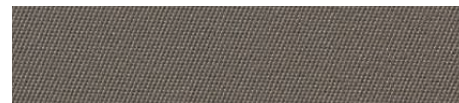

□ 3YA Moonlight Black

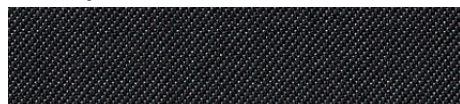

Interior trims

▲ □ 4MG Glacier Silver Aluminum



▲ □ 4A3 Light Burl Walnut Wood



■ □ ▲ 4AS Gray Poplar Wood

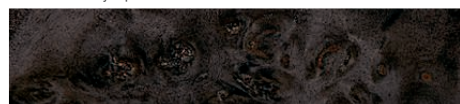

■ ▲ 4AT High-Gloss Black



Recommended color combinations

Interior colors	Leatherette ¹		Boston Leather with Sun-Reflective Technology ²				
	Taupe	Black	Savanna Beige/Black	Taupe	Gray/Black	Coral Red/Black	Black
Upholstery colors							
Exterior colors							
300 Alpine White Non-metallic ¹	●△◆	●△◆	◆◆	●△◆	◆◆	●△◆	●△◆
A61 Crimson Red Non-metallic ^{1,4}	●△◆	●△◆	◆◆	●△◆	◆◆		●△◆
668 Jet Black Non-metallic ^{1,4}	●△◆	●△◆	◆◆	●△◆	◆◆	●△◆	●△◆
354 Titanium Silver Metallic ³		◆◆			◆◆	◆◆	◆◆
A72 Cashmere Silver Metallic ^{3,4}	●△◆	●△◆		●△◆		●△◆	●△◆
A52 Space Gray Metallic ³	◆◆	◆◆		◆◆	◆◆	◆◆	◆◆
A76 Deep Sea Blue Metallic ^{3,4}	●△◆	●△◆	◆◆	●△◆	◆◆		●△◆
A51 Montego Blue Metallic ^{3,4}	●△◆	●△◆	◆◆	●△◆	◆◆		●△◆
381 Le Mans Blue Metallic ^{3,5}		◆◆	◆◆	◆◆	◆◆		◆◆
896 Blue Water Metallic ^{3,4}	●△◆	●△◆	◆◆	●△◆	◆◆		●△◆
475 Black Sapphire Metallic ³	●△◆	●△◆	◆◆	●△◆	◆◆	●△◆	●△◆

Interior trims

4MG Glacier Silver Aluminum		
4A3 Light Burl Walnut Wood		
4AS Gray Poplar Wood		
4AT High-Gloss Black		

¹ Standard.
² Optional, and included in Premium Package.
³ Optional.
⁴ Not available with M Sport Package.
⁵ Requires M Sport Package.

Softtop colors
 ● Black (standard)
 ▲ Taupe
 ◆ Moonlight Black (optional)

bmwusa.com/byo



TURN UP THE HEAT.

The sparkling Black Sapphire Metallic paint is like a tuxedo that makes every drive special, whether it's a day at the races or a night on the town. Inside, the cabin surrounds you with fiery elegance. Coral Red Boston Leather upholstery gets your pulse racing before you even touch the Start button; gleaming Gray Poplar Wood interior trim and rich, pearl gloss-covered surfaces complete the striking effect.





MAKE A SPARKLING IMPRESSION.

Blue Water; sunlight glinting off a calm sea. The name reveals the inspiration behind this metallic paint finish. Inside, the warmth of Taupe Boston Leather upholstery and Light Burl Walnut Wood trim transport you to a 365-day vacation – even when the softtop is up.





■ / □ **Xenon Adaptive Headlights** provide brilliant clarity of the road ahead and to the side at night and in conditions with poor visibility. The dynamic auto-leveling feature adjusts for varying passenger and cargo loads, helping to keep headlight glare out of the eyes of oncoming drivers. BMW Adaptive Headlights provide optimum road illumination around corners, thanks to an electromechanical control system that directs the headlights into and around the bend as soon as the vehicle begins cornering. The Corona headlight-rings that circle both headlights and high beams also act separately as Daytime Running Lights and parking lights. (Standard on 135i; optional on 128i.) □ **Automatic high beams** uses light sensor readings to automatically switch from high beams to low, as needed – such as when there is oncoming traffic or another car ahead, or when the road is sufficiently illuminated.



■ **Foglights** integrated into the deep front spoiler of the 128i enhance your margin of safety in bad visibility. The halogen free-form technology ensures even light distribution on the road. (Not available on 135i.)



□ **Ambiance light package** includes lights in the exterior door handles that radiate downward whenever the doors are unlocked. They illuminate the area outside the doors for approximately 20 seconds to enable safe vehicle access in the dark. Also included are front and rear reading lights, front footwell illumination, vanity mirror lights for driver and front passenger, and ambiance interior lighting.



■ **Rear taillights** are made up of three separate high performance LED strips consisting of multiple rows of long-life LED indicators. The LEDs in each taillight unit provide greater illumination compared to the brightness provided by traditional bulbs.



■ **Adaptive Brake Lights** increase vehicle visibility and signal the intensity of your braking action. In the event of an emergency stop, the illuminated area of the brake lights is increased, so traffic following behind you is warned to stop quickly.



■ **Rain sensor** uses infrared light to measure the amount of rain. When the wipers are in the “intermittent” mode, the rain sensor automatically adjusts the windshield wiping interval as needed. **Automatic headlight control** (not shown), included with rain sensor, activates headlights by means of a sensor that responds to darkness.



■ **Power-folding exterior side-view mirrors** automatically dim when reflecting bright lights, helping to eliminate glare when driving at night.



■ **Door sill with BMW insignia and polished chrome inlay** adds a personal touch to the 1 Series Convertible.



■ **Convertible softtop** (shown here in optional Moonlight Black, with its eye-catching silver effect), is fully automatic and features a multi-layered lining that helps reduce wind and road noise while providing enhanced insulation.



■ **Heated rear window** is made of scratch- and dirt-resistant glass, providing a clear view to the rear in all weather conditions.



□ **Star Spoke (Style 264) light alloy wheels and run-flat¹ performance tires.**² In front: 18 x 7.5 wheels and 215/40 tires; in back: 18 x 8.5 wheels and 245/35 tires.³ (Included in 135i Sport Package.)



■ **Three-spoke leather-wrapped multi-function sport steering wheel** lets you keep both hands on the wheel while adjusting various comfort functions, such as controls for audio system and hands-free phone controls (if so equipped).



■ **V Spoke (Style 360) 16 x 7.0 light alloy wheels with 205/55 run-flat¹ all-season tires.** (Standard on 128i.)



□ **Star Spoke (Style 262) light alloy wheels and run-flat¹ performance tires.**² In front: 17 x 7.0 wheels and 205/50 tires; in back: 17 x 7.5 wheels and 225/45 tires.³ (Included in 128i Sport Package.)



■ **Star Spoke (Style 142) 17 x 7.0 light alloy wheels with 205/50 run-flat¹ all-season tires.** (Standard on 135i.)



□ **Three-spoke, leather-wrapped multi-function M sport steering wheel** lets you keep both hands on the wheel while adjusting various comfort functions. Optional Voice Command (included with optional Navigation system) can be used to change a number of selections and entries.



■ **Power softtop roof control switch** for fully automatic opening and closing of the roof is within arm's reach of the driver and front passenger. Softtop will open and close while traveling at speeds of up to 25 mph.



■ **Cruise Control** lets you store and keep to a chosen speed above 20 mph. It is activated via the left-hand steering column switch and deactivated by applying the brakes or via the switch. (Cruise Control is not a substitute for the driver's own responsibility in adjusting speed and otherwise controlling the vehicle. Due to road, traffic and visibility conditions, the driver decides whether and how the system is used.)

¹ Run-flat tires do not come equipped with spare tire and wheel.

² Performance tires are not recommended for driving in snow and ice.

³ Due to low-profile tires, please note: wheels, tires and suspension parts are more susceptible to road hazard and consequential damages.



□ **Park Distance Control** uses ultrasonic sensors in the rear bumper to help you judge the distance to other cars and unseen objects when parking. The beeping becomes faster as your bumper approaches the object, turning into a constant tone when the distance is less than 12 inches. (Shown with optional Navigation system.)



■ **Instrument panel** features a red backlight speedometer and tachometer. Centered between the two easy-to-read analog instruments is the on-board computer (see at right) with liquid crystal display providing additional important driving information.



■ The **on-board computer** with Check Control provides feedback on the vehicle's operating status: oil level indicator and distance to next service appointment/oil change, as well as other detailed information, such as spark plug and micro-filter status. It also provides travel information: travel range on remaining fuel, external temperature, and more.



■ / □ **Steering wheel-mounted paddle shifters** allow you to shift gears manually without a clutch. In the 135i Convertible, they are included with the optional 7-speed Double Clutch Transmission (DCT). Optional steering wheel-mounted paddle shifters are automatically added in the 128i Convertible when equipped with optional STEPTRONIC automatic transmission and either the Sport Package or M Sport Package. Shown: the three-spoke, leather-wrapped multi-function M sport steering wheel in the 128i Convertible.



□ **6-speed STEPTRONIC automatic transmission** provides a choice of three modes: "Drive," which incorporates BMW's Adaptive Transmission Control; "Sport" automatic, for a more dynamic shift pattern; and STEPTRONIC automatic, for the hands-on control of a manual without using a clutch. (Not available in 135i.)



■ **6-speed manual transmission** delivers a precise, athletic feel. Its responsiveness is due, in part, to the enhanced synchronization of shifts from neutral to each gear. A shortened shift lever and "throw" add to the sporty feel of the gearbox. The sixth gear drops revs at highway speeds for smooth cruising.



□ **7-speed Double Clutch Transmission (DCT) with steering wheel-mounted paddle shifters** in the 135i provides smooth, lightning-quick gear changes by automatically shifting between two transmission structures: while one gear is disengaging, the next is already in position. The result is quicker acceleration and enhanced fuel efficiency. Shift gears manually via steering wheel-mounted paddle shifters or by moving gear selector lever forward/rearward.



■ **Auxiliary input port** lets you connect an external audio source, such as an iPod® or MP3 player.
 □ **iPod and USB adapter** lets you scroll through and select the music you want by using the vehicle's radio controls or the multi-function steering wheel buttons. Music titles are displayed on the radio or Navigation screen.



■ **BMW anti-theft AM/FM stereo CD/MP3 player audio system** includes Radio Data System (RDS).



□ **Harman Kardon Surround Sound System** with vehicle-specific equalizing and powerful 300W amplifier. The 10-speaker system includes four tweeters, four midrange speakers, and two bass speakers located under the front seats.



■ **Automatic climate control system** allows occupants to select a specific cabin temperature and choice of fan speeds, as well as automatic or manual airflow and recirculation. "Convertible" mode also reacts to exterior temperature and sunlight. The automatic recirculation control activates whenever certain air pollutants are detected. The system also includes defrost/demist and MAX A/C functions.



■ **Cupholders** integrated into the center console are located within convenient reach of the driver and front passenger (as shown). See at right for description of cupholders in vehicles with optional Navigation system.



□ **Cupholders** in vehicles with the optional Navigation system are located on the center console and in the passenger footwell. The console-mounted cupholder is detachable for stowing in the glove compartment.



■ **Front armrest** with integrated storage compartment folds up to allow access to the front cupholder(s), shown at far left, and Auxiliary input port shown on page 51.



□ **Eight-way adjustable front sport seats**, shown in optional Taupe Boston Leather, are included in the Sport Package. Side bolsters can be power-adjusted to fit your back comfortably while helping to hold you firmly in place during tight cornering. Includes two-way headrests and thigh support for added support.



■ **Standard front seats**, shown here with optional Black Boston Leather upholstery, offer eight-way manual adjustment, including two-way headrests. The front passenger seat also includes manual height adjustment.



■ **LATCH child seat attachment** on the rear seats provides secure, safe attachment of a child seat with clip-in plug connectors, plus additional fastening points on the upper part.



□ **Heated front seats** are a welcome feature for driver and front passenger in cooler weather. By pressing the icon button, seat surface and backrest are heated and quickly radiate comfortable warmth in your choice of three settings. (Heated front seats are also included in the Cold Weather Package.)



□ **Power seat adjustments** included with eight-way power front seats allow customized comfort and convenience for driver and front passenger. The two-setting memory system automatically adjusts the driver's seat and side-view mirror positions, with individual preferences available at your fingertips.



□ **Lumbar support** for front seats adds four-way power-adjustable comfort for the lower back. Lumbar support can be adjusted up/down and in/out. (Included in optional Premium Package.)

□ **Through-loading hatch** opening includes a **cargo bag** to protect skis, snowboards, and other long items being transported. The cargo bag also serves to protect the interior cabin and trunk surfaces as well. The removable section of the backrest can be laid down and will remain securely in place. (Optional and included in Cold Weather Package.)



Convenience Package: Well thought-out details can make a big difference in making everyday life easier. That's why the Convenience Package adds the practicality of Comfort Access keyless entry, the assistance of rear Park Distance Control, and the reassurance of an Anti-theft alarm to the 128i and 135i. In the 128i, the Convenience Package also includes the enhanced visibility of Xenon Adaptive Headlights.



Xenon Adaptive Headlights provide daytime-like illumination at night and in conditions with poor visibility. When cornering, the Adaptive feature turns the headlights, directing them into and around bends. Corona headlight-rings that circle both headlights and high beams also act separately as Daytime Running Lights and parking lights. (Standard on 135i.)



Anti-theft alarm system features remote control, an anti-theft device and electronic immobilizer for effective protection. In the event of an attempted break-in or any tampering with the vehicle, the system sounds an alarm and immediately switches on the hazard warning lights.



Comfort Access system offers convenient keyless access to your car. Simply carrying the remote key in a pocket or purse allows you to lock or unlock the doors by touching the door handle. You can also turn the engine on or off by pressing the Start/Stop button without inserting the remote key. (Foot must be on the brake; with manual transmission, clutch must also be depressed in order to start.)



Park Distance Control uses ultrasonic sensors in the rear bumper to help you judge the distance to other cars and unseen objects when parking. The beeping becomes faster as your bumper approaches the object, turning into a constant tone when the distance is less than 12 inches. (Shown with optional Navigation system.)

Cold Weather Package: Get to the slopes – or just get around town – in added comfort with the 1 Series Cold Weather Package. Front seat occupants will enjoy the pleasure of three-stage heated seats and the driver will have the added comfort of the heated multi-function steering wheel¹ on those days when the weather turns colder. High-intensity headlight washers² help maintain optimal nighttime visibility in all weather and driving conditions, and the ski bag is a must for protecting skis, poles and other long objects.

¹ Heated multi-function steering wheel not available with M Sport Package or 135i Sport Package.

² Retractable headlight washers standard in 135i.



Transport bag allows clean and secure transport of four pairs of skis and ski poles as well as other long items. When the transport bag is not extended, it can be stored out of sight to save space, and the fold-down center armrest can be left down for use.



Heated front seats are a welcome feature for driver and front passenger in cooler weather. By pressing the icon button, seat surface and backrest are heated and quickly radiate comfortable warmth in your choice of three settings. (Heated front seats are also available as an optional item.)

Sport Package: Inject more excitement into every drive. Specially bolstered eight-way adjustable sport seats cradle you comfortably while holding you firmly in place during sporty driving maneuvers. Eye-catching shadowline trim around the windows and door sills add to the Convertible's sporty appearance. In the 135i, larger rear wheels and run-flat³ performance tires⁴ team up with the sport-tuned suspension to grip corners with a vengeance.

³ Run-flat tires do not come equipped with spare tire and wheel.

⁴ Performance tires are not recommended for driving in snow and ice. Due to low-profile tires, please note: wheels, tires and suspension parts are more susceptible to road hazard and consequential damages.



Star Spoke (Style 264) light alloy wheels and run-flat³ performance tires.⁴

In front: 18 x 7.5 wheels and 215/40 tires; in back: 18 x 8.5 wheels and 245/35 tires.⁴ (Included in 135i Sport Package.)



Eight-way adjustable front sport seats make the driving experience more enjoyable. Side bolsters can be power-adjusted to fit your back comfortably while helping to hold you firmly in place during tight cornering. Includes two-way headrests and thigh support for added support. (Shown with optional Taupe Boston Leather upholstery.)

Three-spoke, leather-wrapped multi-function M sport steering wheel, included in the 135i Sport Package, lets you keep both hands on the wheel while adjusting various comfort functions, such as changing the radio, CD selections and volume. Optional Voice command (included with optional Navigation system) can be used to change radio stations and audio selection, Navigation system destinations, and (accessory) telephone entries. When equipped with optional Double Clutch Transmission, includes steering wheel-mounted paddle shifters. (Not available with heated steering wheel feature, or 128i Sport Package.)



In the **Premium Package**, eight-way power-adjustable front seats, upholstered in supple Boston Leather, offer the customized comfort of four-way lumbar support. At night you'll appreciate the enhanced visibility afforded by the Ambiance light package, the auto-dimming function of the rear-view mirror (which also includes a digital compass), and the power-adjustable folding exterior side-view mirrors. BMW AssistTM offers roadgoing peace of mind, while Bluetooth[®] wireless technology lets you keep in touch without taking your eyes from the road. And the integrated three-button Universal garage-door opener takes the place of up to three separate remote-control devices, helping to eliminate clutter.



Ambiance light package includes lights in the exterior door handles that radiate downward whenever the doors are unlocked, illuminating the area outside the doors for approximately 20 seconds to enable safe vehicle access in the dark. Also included are front reading lights, front footwell illumination, vanity mirror lights for driver and front passenger, and ambiance interior lighting.



Power-folding exterior side-view mirrors automatically dim when reflecting bright lights, helping to eliminate glare when driving at night.



The automatic-dimming inside rear-view mirror darkens in response to the bright headlights of vehicles behind you. The easy-to-read digital compass, integrated into the mirror, is a convenient way to constantly keep your bearings while driving.



BMW Assist⁵ and Bluetooth[®] system offers hands-free calling through your BMW-approved Bluetooth phone. The BMW Assist Safety Plan is included for four years, providing Automatic Collision Notification, Emergency and Roadside Assistance, Door Unlock, Stolen Vehicle Recovery, TeleService and more.

⁵ The optional Convenience Plan offers Directions, Traffic, Weather, Critical Calling and Concierge services. See page 66 for detailed information on standard and optional services.



Power seat adjustments included with eight-way power front seats allow customized comfort and convenience for driver and front passenger. The two-setting memory system automatically adjusts the driver's seat and side-view mirror positions, with individual preferences available at your fingertips.



Lumbar support for front seats adds four-way power-adjustable comfort for the lower back. Lumbar support can be adjusted up/down and in/out.

M Sport Package: Bring the proud tradition of BMW M right to your doorstep, starting with the tri-color M logo on the door sills. Bolstered front sport seats, coupled with the three-spoke M sport multi-function steering wheel,¹ add to the driving excitement. The available Le Mans Blue Metallic paint and black shadowline trim project the image of serious performance. M Double Spoke (Style 207M) light alloy wheels (17 x 7.0 front/17 x 7.5 rear) and run-flat² performance tires³ are included in the 128i M Sport Package; the 135i M Sport Package adds M Double Spoke (Style 261M) light alloy wheels (18 x 7.5 front/18 x 8.5 rear) and run-flat² performance tires.³

¹When the M Sport Package and STEPTRONIC automatic transmission are ordered, optional steering wheel-mounted paddle shifters are automatically added.

²Run-flat tires do not come equipped with spare tire and wheel.

³Performance tires are not recommended for driving in snow and ice. Due to low-profile tires, please note: wheels, tires and suspension parts are more susceptible to road hazard and consequential damages.



The **Aerodynamic kit** includes a front air dam with generous air intakes, dynamic side skirts and an athletic rear spoiler. The M Sport chassis is lowered by 0.6" for tighter handling when cornering and a more aggressive look. Shadowline trim and chrome exhaust tips enhance the sporty attitude. (Foglights on 128i only; not available on 135i M Sport Package.)



Foglights integrated into the front apron of the 128i ensure greater visibility in inclement weather. (Not available on 135i.)



BMW Double Spoke (Style 207M) light alloy wheels and run-flat² performance tires.³ In front: 17 x 7.0 wheels and 205/50 tires; in back: 17 x 7.5 wheels and 225/45 tires. (128i M Sport Package.)



BMW Double Spoke (Style 261M) light alloy wheels and run-flat² performance tires.³ In front: 18 x 7.5 wheels and 215/40 tires; in back: 18 x 8.5 wheels and 245/35 tires. (135i M Sport Package.)



Door sills with the instantly identifiable M logo announce that this is a special breed of convertible as soon as the door is opened.



Three-spoke, leather-wrapped multi-function M sport steering wheel is included in the M Sport Package. The thick, textured rim and thumb indents are designed for performance driving, while multi-function buttons allow you to adjust various comfort features while keeping both hands on the wheel.



Eight-way adjustable front sport seats make the driving experience more enjoyable. Side bolsters can be power-adjusted to fit your back comfortably while helping to hold you firmly in place during cornering. Includes two-way manual headrests and thigh support.

Exclusively in the BMW 135i Convertible:

A wealth of unique performance and styling enhancements include an enhanced DSC system, specially calibrated sport suspension and sporty throttle character that help make the most of the 135i's 300-hp TwinPower Turbo engine. Oversize ventilated disc brakes provide sure stopping power for the Star Spoke (Style 142) 17 x 7.0 light alloy wheels with 205/50 run-flat² all-season tires. Xenon Adaptive Headlights and heated headlight washer jets improve your roadgoing vision. A special front apron with functional air intakes adds to the 135i's handling, while the Aerodynamic kit, which includes side skirts and a sporty rear apron, lends it an even more chiseled look. Your choice of distinctive trims, including genuine wood, personalize the interior.

Rear apron not only adds to the sporty look of the 135i Convertible, it helps reduce drag at higher speeds. (Optional Sport Package Style 264 wheels shown.)



Front apron sits below the BMW double kidney-shaped grille with chrome slats. This feature, which brings a constant flow of fresh air to the engine, adds to the front's impressive athletic profile. The central air intake is flanked by two side air intakes that cool the brakes. Two side flaps accentuate the broad front.



High-performance disc brakes, with inner ventilation and "BMW" painted on the calipers (6-piston calipers in front/2-piston calipers in the rear) measure 13.3" front/12.8" rear. Designed for high-performance driving, their large diameters help provide shorter braking distances and superior stopping ability.



Black chrome-plated double tailpipe is standard on the 135i Convertible's exhaust system.



Dashboard features easy-to-read numbers with special scales that include additional display ranges in the instrumentation.



Designed for high-performance lifestyles: a rear-mounted dual-bicycle carrier; wind deflector with a decorative graphic; and 18" Double Spoke (Style 182) light alloy wheels.

EQUIPPED WITH THE BEST IDEAS. ORIGINAL BMW ACCESSORIES.

Driving a BMW is always a special experience – and it can be further enhanced with Original BMW Accessories. Benefit from innovative solutions that combine striking design and inspired functionality. BMW Accessories are available in many categories: exterior, interior, mobile communications, transportation and storage. One example is the locking rear bicycle rack, which allows you to transport two bicycles, and then slides back conveniently when you want to open the trunklid. To find out more about this and other accessories, contact your preferred authorized BMW center. There you will find a wide selection of quality items, as well as a special brochure detailing the entire range of Original BMW Accessories to fit your 1 Series.



iPhone™ USB Snap-in Adapter for BMW Smart Phone plays stored music, accesses the car antenna and charges the phone.

PASSION FOR PERFORMANCE MEANS REFUSING TO COMPROMISE. BMW PERFORMANCE.

Choosing a BMW shows you value dynamic driving, innovative technology and sporty style. Now you can express your passion to the ultimate degree with the exciting new BMW Performance line.

BMW designers took their inspiration from BMW M – the heart and soul of BMW motorsport – to create this collection of track-bred accessories. From aerodynamic components to Carbon Fiber trims,

high-performance chassis and brake enhancements to M style interior appointments, these accessories allow you to individualize the look and performance of your BMW.

For more information on BMW Performance, see your preferred authorized BMW center or visit us online.

accessories.bmwusa.com



BMW Performance Carbon Fiber exterior mirror provides strength and styling.



BMW Performance Steering Wheel's thicker grip provides enhanced control.



BMW Performance Shift Knob offers a high-tech look with a non-slip grip.

■ Standard equipment □ Optional equipment

BMW Accessories | Safety illustrations 58159

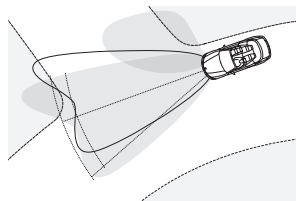

■ / □ Xenon Adaptive Headlights automatically swivel to follow the curves of the road. The system uses data from on-board sensors and the steering wheel angle to determine the car's direction, then adjusts the headlights accordingly. The system offers outstanding nighttime vision. (Standard on 135i; optional on 128i.)

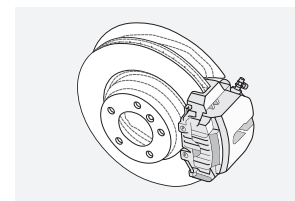

■ Massive, high-performance anti-lock disc brakes are ventilated at all four wheels for fade-resistant operation under hard use. (See page 65 for brake diameter sizes.)

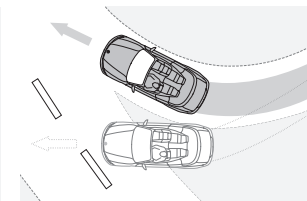

■ Dynamic Stability Control (DSC) with Dynamic Traction Control (DTC) features Brake Drying, Brake Stand-by, Brake Fade Compensation and Start-off Assistant. DSC is a braking control system that helps to stabilize a vehicle when it senses a loss of control. If the system senses over- or under-steer, it responds with counter-measures to help keep the vehicle under control.

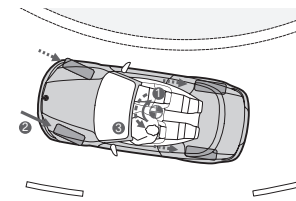

■ Cornering Brake Control increases vehicle stability by proportioning the braking force while turning. When you brake in a turn, the pressure comes off the rear wheels, which causes the vehicle to swerve inward (oversteer) (1) Cornering Brake Control counteracts this action by asymmetrically adjusting brake pressure (2), creating stabilizing counter-torque (3), independently of the ABS system.

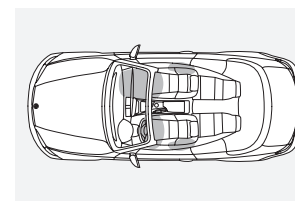

■ In a collision, BMW's SRS (supplemental restraint system) with advanced technology for the front airbags determines which airbags to deploy for optimal protection. The system also includes front-seat-mounted side-impact airbags.

Please note: These pictures of airbags are for illustrative purposes only. Depending upon the type of accident, none, some or all airbags may deploy.



■ BMW restraint system for the driver and front passenger combines three-point safety belts, automatic safety-belt pretensioners, head restraints, and seat bolsters that help prevent occupants from sliding forward. This system helps provide optimum restraint in a collision.

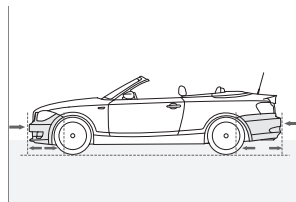

■ Impact-absorbing bumpers and compressible "crush tubes" front and rear help absorb the force of impact in collisions up to nine mph, minimizing damage to the vehicle's body and simplifying repairs. Only at higher impact speeds do structural supports begin to deform, dissipating impact energy to help protect occupants.

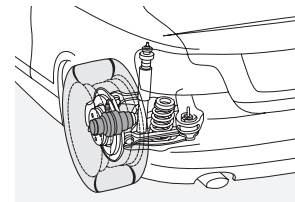

■ Tire Pressure Monitor is an electronic control system designed to warn the driver if there is a sudden and irregular loss of tire pressure. Should the target pressure of a tire fall below 25%, a warning light alerts the driver.

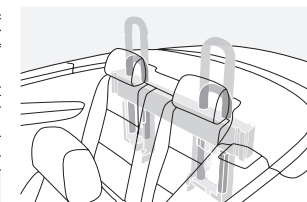

■ Rollover safety system consists of two steel rollbars behind the rear-seat headrests that are connected with a highly stable chassis crossbeam. The system includes a rollbar of high-strength tubular steel integrated into the frame of the windshield.

Performance and efficiency	128i	135i
3.0-liter dual overhead cam (DOHC), 24-valve inline 230-hp 6-cylinder engine with composite magnesium/aluminum engine block, Valvetronic, and Double-VANOS steplessly variable valve timing	●	
3.0-liter dual overhead cam (DOHC), 24-valve inline turbocharged 300-horsepower 6-cylinder engine with TwinPower Turbo technology, Valvetronic, and Double-VANOS steplessly variable valve timing		●
Electronic throttle control	●	●
6-speed manual transmission	●	●
6-speed STEPTRONIC automatic transmission with Adaptive Transmission Control	○	
7-speed Double Clutch Transmission (includes steering wheel-mounted paddle shifters)		○
Steering wheel-mounted paddle shifters (included with 7-speed Double Clutch Transmission; require and are automatically added with either Sport Package or M Sport Package and STEPTRONIC transmission)	○	○

Handling, ride and braking	128i	135i
Dynamic Stability Control (DSC), including Brake Fade Compensation, Start-off Assistant, Brake Drying, and Brake Stand-by features, with Dynamic Traction Control (DTC)	●	●
Extensive aluminum componentry, including front suspension components (forged-aluminum lower arms); subframe; steering rack; and brake components	●	●
Aluminum double-pivot spring and strut-type front suspension	●	●
Five-link fully independent rear suspension in lightweight steel	●	●
Front and rear anti-roll (stabilizer) bars	●	●
Twin-tube gas-pressure shock absorbers	●	●
Sport suspension calibration	□/■	●
4-wheel ventilated anti-lock disc brakes with Dynamic Brake Control (DBC)	●	●
Active Steering		○
Increased top-speed limiter	□/■	□/■

Exterior and aerodynamics	128i	135i
V Spoke (Style 360) 16 x 7.0 light alloy wheels and 205/55 run-flat ¹ all-season tires	●	
Star Spoke (Style 142) 17 x 7.0 light alloy wheels and 205/50 run-flat ¹ all-season tires		●
Star Spoke (Style 262) light alloy wheels, 17 x 7.0 front, 17 x 7.5 rear; 205/50 front, 225/45 rear run-flat ¹ performance tires ²	□	
Star Spoke (Style 264) light alloy wheels, 18 x 7.5 front, 18 x 8.5 rear; 215/40 front, 245/35 rear run-flat ¹ performance tires ²		□
M Double Spoke (Style 207M) light alloy wheels, 17 x 7.0 front, 17 x 7.5 rear; 205/50 front, 225/45 rear run-flat ¹ performance tires ²	■	
M Double Spoke (Style 261M) light alloy wheels, 18 x 7.5 front, 18 x 8.5 rear; 215/40 front, 245/35 rear run-flat ¹ performance tires ²		■
Xenon Adaptive Headlights with auto-leveling, and Cornering Lights	○/◆	●
Halogen free-form front foglights	●	
High-intensity headlight washers	★	●
Heated dual power mirrors and heated windshield washer jets	●	●
Chrome-plated exhaust tips	●	
Black chrome-plated exhaust tips		●
Gray-band windshield	●	●
Fully lined power-folding automatic softtop with heated glass rear window and electric rear defroster	●	●
Black softtop	●	●
Taupe softtop (not available with Savanna Beige/Black Boston Leather)	▲	▲
Moonlight Black (Anthracite with silver effect) softtop	○	○
Aerodynamic kit	■	
Chrome-line exterior trim	●	●
Shadowline exterior trim	□	□
Metallic paint	○	○

- Standard
- ◆ Included in Convenience Package
- Optional
- ★ Included in Cold Weather Package
- Included in Sport Package
- ◇ Included in Premium Package
- Included in M Sport Package
- ▲ No-cost option

¹ Run-flat tires do not come equipped with spare tire and wheel.
² Due to low-profile tires, please note: wheels, tires and suspension parts are more susceptible to road hazard and consequential damages. Performance tires are not recommended for driving in snow and ice.

Interior seating and trim	128i	135i
8-way adjustable front seats, including 2-way headrests	●	●
Manual height adjustment for front passenger seat	●	●
8-way power front seats with 2-way manual headrests and driver memory with 2 presets for seat and exterior mirror positions	○/◇	○/◇
8-way adjustable front sport seats with adjustable side bolsters, 2-way headrests and thigh support	□/■	□/■
8-way power front sport seats with adjustable side bolsters, 2-way manual headrests and thigh support, and driver memory with 2 presets for seat and exterior mirror positions (optional power seats or Premium Package required)	□/■	□/■
4-way adjustable power lumbar support for front seats	◇	◇
Leatherette upholstery	●	●
Boston Leather upholstery with Sun-Reflective Technology (covers the fronts of all seats and headrests)	○/◇	○/◇
High-Gloss Black trim	●	▲
Gray Poplar Wood trim	○/◇	●
Light Burl Walnut Wood trim	○/◇	▲
Glacier Silver Aluminum trim (required with M Sport Package)	○/◇	▲
3-stage heated front seats	○/★	○/★
M door sills with M logo, M footrest, M gearshift knob, and M handbrake lever	■	■

Comfort and convenience	128i	135i
Engine Start/Stop button	●	●
Comfort Access keyless entry with multi-function remote control	○/◆	○/◆
Automatic climate control—includes micro-filter, automatic air recirculation, left/right temperature control, "Convertible" mode, MAX A/C, heat at rest, and recall of individual user settings	●	●
Front-door storage compartments	●	●
Front-seat center armrest	●	●
Front-seat cupholders	●	●
Tilt/telescopic steering-wheel column	●	●
Heated steering wheel (not available with Sport Package or M Sport Package; requires Cold Weather Package)	○	○
Park Distance Control (PDC) (rear only)	○/◆	○/◆
Interior and power-adjustable folding exterior mirrors with automatic-dimming function	◇	◇
Digital interior mirror compass	◇	◇
Power front windows with "one-touch" up/down operation	●	●
Cruise Control	●	●
Automatic high beams	○	○
Ambiance light package, including BMW Ambiance interior lighting	◇	◇
Through-loading system with integrated transport bag	○/★	○/★
Rain-sensing windshield wipers and Automatic headlight control	●	●
Integrated 3-button Universal garage-door opener	◇	◇

Instrumentation and controls	128i	135i
3-spoke leather-wrapped multi-function sport steering wheel with audio and hands-free phone controls (if so equipped)	●/□	●
3-spoke leather-wrapped multi-function M sport steering wheel with audio and hands-free phone controls (if so equipped) (not available with Heated steering wheel)	■	□/■
Service Interval Indicator with miles-to-service readout	●	●
Check Control vehicle monitor system with pictogram display, oil status display, and Condition Based Service indicator	●	●
Tire Pressure Monitor	●	●
On-board computer with Check Control—provides feedback on the vehicle's operating status: oil level indicator and distance to next service appointment/oil change, as well as other detailed information, such as spark plug and micro-filter status. It also provides travel information—travel range on remaining fuel, external temperature, and more	●	●
BMW Navigation system with Voice command System and Real Time Traffic Information (where available); iDrive system with high-function on-board computer and Controller, with 6 programmable memory keys (also includes Online Information Services when equipped with BMW Assist™)	○	○

Audio system	128i	135i
Anti-theft AM/FM stereo CD/MP3 player audio system with Radio Data System (RDS)	●	●
Harman Kardon Surround Sound Audio System with vehicle-specific equalizing and powerful 300W amplifier; the 10-speaker system includes 4 tweeters, 4 midrange speakers, and 2 bass speakers located under the front seats	○	○
Auxiliary audio input for portable music players located in the center armrest	●	●
SIRIUS Satellite Radio with one-year subscription	○	○
iPod® and USB adapter (includes cable connector)	○	○
Smartphone integration (requires iPod and USB adapter and Premium Package or BMW Assist™)	○	○
HD Radio™ with "multicast" FM station reception	●	●

Safety and security	128i	135i
Anti-lock braking system (ABS)	●	●
Adaptive Brake Lights	●	●
BMW's Advanced Safety System for integrated deployment of passive and active safety systems	●	●
Rollover Protection System	●	●
Driver's and passenger's front airbag supplemental restraint system (SRS) with advanced technology: dual-threshold, dual-stage deployment; and front-passenger seat sensors designed to prevent unnecessary airbag deployment	●	●
Front passenger seat-occupation recognition with Passenger's Airbag Off indicator	●	●
Automatic safety-belt pretensioners at front seating positions	●	●
Front-seat-mounted side-impact airbags	●	●
Interlocking door anchoring system to help protect against door intrusion in side impacts	●	●
Central locking system with center console switch (leaves gas filler door unlocked), double-lock feature and 2-step unlocking	●	●
Coded Driveway Protection	●	●
Anti-theft alarm system	○/◆	○/◆
Automatic-locking retractors (ALR) on all passenger-seat safety belts for installation of child-restraint seat	●	●
LATCH attachments for child-restraint safety installation in rear seats	●	●
Crash sensor that activates Battery Safety Terminal disconnect of alternator, fuel pump and starter from battery; automatically unlocks doors, and turns on hazard and interior lights	●	●
Programmable Daytime Running Lights	●	●
BMW Assist with Bluetooth® wireless technology for hands-free calling (with Bluetooth enabled mobile phone), with phonebook downloading and speech recognition capabilities (please visit your authorized BMW center for details on standard and optional services and a list of BMW-approved Bluetooth technology enabled mobile phones; also includes Online Information Services when equipped with BMW Navigation system)	○/◇	○/◇

BMW Services	128i	135i
BMW Ultimate Service™ (for complete details on BMW Ultimate Service, visit bmwusa.com/ultimateservice)	●	●

Convenience Package	128i	135i
Xenon Adaptive Headlights with auto-leveling, and Cornering Lights	○/◆	●
Comfort Access keyless entry with multi-function remote control	○/◆	○/◆
Park Distance Control (PDC) (rear only)	○/◆	○/◆
Anti-theft alarm system	○/◆	○/◆

- Standard
- Optional
- ◆ Included in Convenience Package
- ◇ Included in Premium Package
- Included in Sport Package
- Included in M Sport Package
- ★ Included in Cold Weather Package

³ Run-flat tires do not come equipped with spare tire and wheel.
⁴ Due to low-profile tires, please note: wheels, tires and suspension parts are more susceptible to road hazard and consequential damages. Performance tires are not recommended for driving in snow and ice.

Premium Package	128i	135i
8-way power front seats with 2-way manual headrests and driver memory with 2 presets for seat and exterior mirror positions	◇	◇
4-way adjustable power lumbar support for front seats	◇	◇
Boston Leather upholstery (covers the fronts of all seats and headrests)	◇	◇
Interior and power-adjustable folding exterior mirrors with automatic-dimming function	◇	◇
Digital interior mirror compass	◇	◇
Ambiance light package, including BMW Ambiance interior lighting	◇	◇
Integrated 3-button Universal garage-door opener	◇	◇
Wood interior trim	○/◇	●
BMW Assist with Bluetooth® wireless technology for hands-free calling (with Bluetooth enabled mobile phone), with phonebook downloading and speech recognition capabilities (please visit your authorized BMW center for details on standard and optional services and a list of BMW-approved Bluetooth technology enabled mobile phones; also includes Online Information Services when equipped with BMW Navigation system)	◇	◇

Sport Package (not available with M Sport Package)	128i	135i
Star Spoke (Style 262) light alloy wheels, 17 x 7.0 front, 17 x 7.5 rear; 205/50 front, 225/45 rear run-flat ³ performance tires ⁴	□	
Star Spoke (Style 264) light alloy wheels, 18 x 7.5 front, 18 x 8.5 rear; 215/40 front, 245/35 rear run-flat ³ performance tires ⁴		□
8-way adjustable front sport seats with adjustable side bolsters, 2-way headrests and thigh support	□	□
8-way power front sport seats with adjustable side bolsters, 2-way manual headrests and thigh support, and driver memory with 2 presets for seat and exterior mirror positions (optional power seats or Premium Package required)	□	□
Sport suspension calibration	□	●
3-spoke leather-wrapped multi-function M sport steering wheel with audio and hands-free phone controls (if so equipped) (not available with Heated steering wheel; includes paddle shifters when equipped with 7-speed Double Clutch Transmission)		□
Steering wheel-mounted paddle shifters (included with 7-speed Double Clutch Transmission; require and are automatically added with either Sport Package or M Sport Package and STEPTRONIC transmission)	○	○
Shadowline exterior trim	□	□
Increased top speed limiter	□	□

M Sport Package (not available with Sport Package)	128i	135i
M Double Spoke (Style 207M) light alloy wheels, 17 x 7.0 front, 17 x 7.5 rear; 205/50 front, 225/45 rear run-flat ⁴ performance tires ⁴	■	
M Double Spoke (Style 261M) light alloy wheels, 18 x 7.5 front, 18 x 8.5 rear; 215/40 front, 245/35 rear run-flat ⁴ performance tires ⁴		■
8-way adjustable front sport seats with adjustable side bolsters, 2-way headrests and thigh support	■	■
8-way power front sport seats with adjustable side bolsters, 2-way manual headrests and thigh support, and driver memory with 2 presets for seat and exterior mirror positions (optional power seats or Premium Package required)	■	■
Sport suspension calibration	■	●
3-spoke leather-wrapped multi-function M sport steering wheel with audio and hands-free phone controls (if so equipped) (not available with Heated steering wheel; includes paddle shifters when equipped with Double Clutch Transmission)	■	■
Steering wheel-mounted paddle shifters (included with 7-speed Double Clutch Transmission; require and are automatically added with either Sport Package or M Sport Package and STEPTRONIC transmission)	○	○
Shadowline exterior trim	■	■
Aerodynamic kit	■	●
M door sills with M logo, M footrest, M gearshift knob, and M handbrake lever	■	■
Increased top speed limiter	■	■

Cold Weather Package	128i	135i
Transport bag	★	★
3-stage heated front seats	★	★
High-intensity headlight washers	★	●
Heated steering wheel (not available with M Sport Package or 135i Sport Package)	★	★

Weight		128i	135i
Unladen weight	lb	3494 (3571)	3638 (3704)
Weight distribution, front/rear			
Manual transmission	%	48.3/51.7	49.4/50.6
Automatic transmission (128i: STEPTRONIC transmission; 135i: 7-speed Double Clutch Transmission [DCT])	%	49.1/50.9	49.7/50.3

Engine		128i	135i
Liters/type/valves per cylinder		3.0/inline 6/4	TwinPower Turbo 3.0/inline 6/4
Bore/Stroke	inch	3.35/3.46	3.31/3.53
Nominal output/rpm	hp	230/6500	300/5800
Maximum torque/rpm	lb-ft	200/2750	300/1200-5000
Compression ratio	:1	10.7	10.2
Fuel grade		unleaded premium	unleaded premium

Transmission		128i	135i
Manual gear ratios			
I/II/III	:1	4.32/2.46/1.66	4.11/2.32/1.54
IV/V/VI/R	:1	1.23/1.00/0.85/3.94	1.18/1.00/0.85/3.73
Final drive ratio	:1	3.23	3.08
Automatic gear ratios			
I/II/III/IV	:1	4.07/2.37/1.55/1.16	4.78/3.06/2.15/1.68
V/VI/VI/R	:1	0.85/0.67/—/3.20	1.39/1.20/1.00/4.45
Final drive ratio	:1	3.73	3.46

Performance		128i	135i
Drag coefficient	C_d	0.34	0.34
Top speed ¹	mph	130	130
Acceleration 0-60 mph ² (128i: STEPTRONIC transmission; 135i: 7-speed Double Clutch Transmission [DCT])	sec	6.4 (7.0)	5.4 (5.3)

Fuel consumption ³		128i	135i
Manual transmission – City/Highway	mpg	18/28	19/28
Automatic transmission – City/Highway (128i: STEPTRONIC transmission; 135i: 7-speed Double Clutch Transmission [DCT])	mpg	18/27	18/25
Fuel tank capacity, approx.	gal	14	14

Figures in () apply to vehicles with automatic transmission, if different from manual transmission.

¹Top speed limited electronically. All-season tires limited to 130 mph; Sport Package and M Sport Package top-speed limiter increased to 150 mph.

²BMW AG test results. BMW urges you to obey all posted speed laws and always wear safety belts.

³EPA-estimated figures are for comparison purposes only. Your actual mileage will vary, depending on speed, driving habits, trip length and driving conditions; actual mileage may be lower.

Tires and wheels	128i	135i
Tire dimensions – standard	205/55	205/50
Wheel dimensions – standard	16 x 7.0	17 x 7.0
Material	light cast alloy	light cast alloy

Brakes		128i	135i
Front – diameter	inch	11.8	13.3
Rear – diameter	inch	11.8	12.8

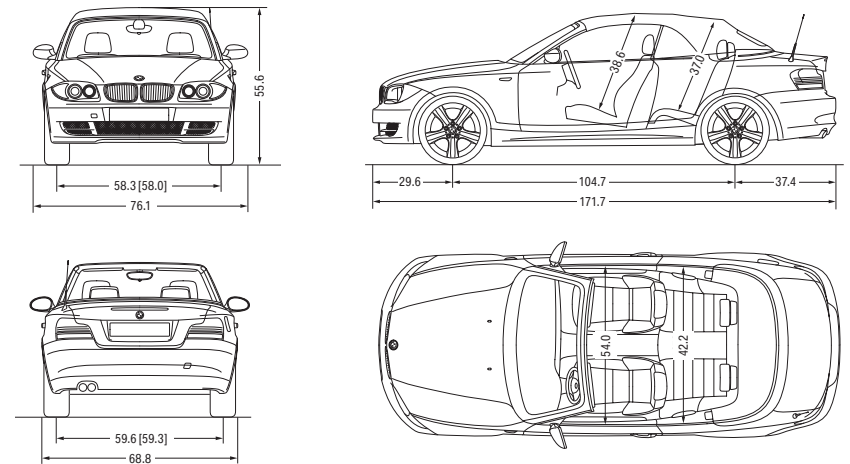

All dimensions are shown in inches, and apply to the 128i with standard wheels. Figures in [] refer to 135i.

We constantly monitor your BMW's needs – so you don't have to. Tackling mountain switchbacks, the last thing you should be thinking about is the state of your brake pads. Thanks to BMW's integrated on-board diagnostics system, you will always know exactly when the next service is due, and what work will be required.

Condition-Based Service (CBS) measures the condition of key parts that are subject to wear and tear. It also tracks fluid levels and monitors your BMW's time- and mileage-dependent service requirements. Using this data, the Info

Display in the cockpit automatically alerts you in advance whenever any part of your vehicle will require servicing. You can also use the optional iDrive Control Display to find out which components will need to be serviced, and when.

When combined with TeleService – the innovative telematics service included with the optional BMW Assist™ Safety Plan¹ – the CBS-collected data is automatically transmitted to your BMW center, which then contacts you to set up a service appointment. And because they use only **Original BMW Parts**, you can rely on expert fit and long-lasting BMW quality.

JOY IS THE FEELING OF BEING LOOKED AFTER BY THE BEST. BMW SERVICE FOR YOUR BMW.

BMW Ultimate Service.™ At BMW, we believe that a premium ownership experience should feature performance and luxury, as well as safety and convenience. We believe you should be able to drive a BMW to its potential, while enjoying peace of mind and reduced cost of ownership. That's the idea behind BMW Ultimate Service: a suite of comprehensive programs and services that are included with every new vehicle. The New Vehicle Limited Warranty, the BMW Maintenance Program, and Roadside Assistance come standard, with BMW Assist offered as an option. BMW Ultimate Service starts with the **New Vehicle Limited Warranty**, providing you with coverage for the first four years or 50,000 miles, whichever comes first. Additionally, you have 12-year, unlimited-mileage warranty protection against corrosion and rust perforation.² **BMW Maintenance Program** is one of the most comprehensive maintenance programs in its class. We cover all factory-recommended maintenance during the New Vehicle Limited Warranty coverage period. This includes scheduled oil services and inspections. Also covered is the replacement of items that are subject to normal wear and tear, such as brake pads, wiper blade inserts and engine drive belts.³ And, thanks to BMW's advanced engineering, most owners enjoy a well-balanced maintenance schedule, with flexible routine service intervals that can save you time. When your vehicle requires attention, your authorized BMW center ensures that it receives only genuine BMW parts – your assurance of exacting quality standards.

BMW Roadside Assistance is provided free of charge for the first four years – with no mileage limit. Call **1-800-332-4BMW (4269)** for friendly on-the-road help, 24/7, anywhere in the United States, Canada and Puerto Rico. This includes everything from flat-tire changes, emergency gasoline and lock-out service, to towing, alternative transportation and even trip-interruption benefits. This service also provides valuable trip-routing advice.

The **BMW Assist** Safety Plan is an optional four-year program. You'll enjoy peace of mind knowing that a friendly response specialist is there to help you, 24/7, at just the push of a button. The Safety Plan includes Automatic Collision Notification, Emergency Request, Enhanced Roadside Assistance, Door Unlock, Stolen Vehicle Recovery and Customer Relations. Included in the BMW Assist Safety Plan, MyInfo allows you to send business locations and street addresses with their associated phone numbers from the Google Maps™ website directly to your BMW. The destination can be sent to your Navigation system for turn-by-turn directions. With the BMW Navigation system and certain BlackBerry smartphones linked to your BMW via Bluetooth® technology, BMW's Mobile Office feature transfers text messages and emails to your iDrive Display screen and reads them aloud to you. A Calendar and To-do List can also appear on your Display screen while en route. Running late? Click on the phone number in the Calendar to call your appointment.

For the ultimate in coverage, add the optional **Convenience Plan**.⁴ You'll enjoy unlimited access to personalized Directions, Traffic and Weather reports, as well as our Concierge feature, which can send a destination address and phone number, such as a restaurant or hotel, right to your BMW. You can make up to four operator-assisted calls per year with Critical Calling if your cell phone is not available, or if its battery is discharged. BMW Search allows online access to up-to-date fuel prices and the latest weather forecasts, as well as Bloomberg's stock indices and the powerful reach of the Google Maps database – delivered to the iDrive Display right inside your vehicle.

BMW's unique **TeleService**, included in the BMW Assist Safety Plan, continually monitors specific parts that are subject to wear and tear – including the engine oil, micro-filter, spark plugs, brake linings and various fluids – as well as services that require attention at regular intervals, such as vehicle service inspections. This data is automatically transmitted to your BMW center, which will then call you to schedule a service appointment. You don't have to keep track of when your vehicle requires routine maintenance. An added benefit: any needed maintenance service parts will already be on hand, so your BMW is serviced and returned to you as quickly as possible.

For more details on BMW Ultimate Service, visit your authorized BMW center or log on to bmwusa.com/ultimateservice.



JOY COMES IN MANY FORMS.

BMW Virtual Center.

If you get the sudden urge to shop for a BMW but your BMW center is closed, there's good news – the BMW Virtual Center is open 24 hours a day! Log on to bmwusa.com, and in the top navigation bar, choose "Build Your Own," and then the model that interests you. Configure the BMW of your dreams, and see what the monthly payments would be. You can even send the specifications to your authorized BMW center, apply for financing, or request a test drive – all online!

BMW Financial Services.

Arranging to buy or lease a BMW is easier than you may think. Your authorized BMW center offers leasing and financing to suit your personal needs through BMW Financial Services.⁵ Start the process at our website, where you can build your "dream vehicle," get an estimate on a monthly lease or financing payment, submit a credit application to BMW Financial Services – and get approval – all online!⁶ To find out how BMW Financial Services can help put you behind the wheel of your favorite BMW model, log on to bmwusa.com/fs or call, toll-free, **1-800-578-5000**.

BMW Publications in "Media Gallery & Library."

Sent to new owners and lessees several times a year, **BMW Magazine** is a fascinating view of the latest events and products in the world of BMW, including personality profiles, travel reviews, and the latest BMW technologies. You can read articles from **BMW Magazine** on the BMW website at bmwusa.com under the "Media Gallery & Library" heading, found in the "Experience" section. Here, you can also view featured videos and images, read recent news articles, and download BMW wallpapers. While you're there, check out the "News Feed" area to enjoy articles from **Inside Track**. For more information, call Customer Assistance at **1-800-334-4BMW (4269)** or visit BMW online at bmwusa.com.

The new **BMW Welt** ("BMW World") delivery and brand-experience center in Munich is bold proof of BMW's passion for design. When you take advantage of the BMW European Delivery Program,⁶ this is where you will meet your new BMW – in a personalized process that is highly dramatic and totally unforgettable. (You might also realize substantial savings that just may pay for your trip.) While you're there, marvel at the historic BMWs in the Museum; learn about our engineers' newest innovations in the Technology and Design Atelier; and take a tour of the plant to experience firsthand the state-of-the-art methods used to create a BMW. Then comes the unique experience of driving your new BMW on the roads it was designed for. To learn more, visit bmwusa.com/europeandelivery.

¹ The BMW Assist and Bluetooth Hands-free Calling system with 4 years of Safety Plan services is optional or included in the Premium Package. In order to receive BMW Assist services, a subscriber agreement must be completed and transferred to the BMW Assist Response Center. GPS and underlying wireless services must be available and functioning; vehicle ignition must be turned on (except for Door Unlock and Stolen Vehicle Recovery), battery charged and connected and vehicle's electrical system operational; services may be limited to certain geographic areas. Call toll-free **1-888-333-6118**, go to bmwassist.com, or visit your BMW center for additional program details. Services are subject to the terms and conditions of your subscriber agreement.

² See your authorized BMW center for details on these limited warranties.

³ The BMW Maintenance Program covers factory-recommended maintenance services as determined by the Service Interval Indicator for all new eligible MY2004 and later BMW vehicles. Specific additional items that need replacement due to normal wear and tear are also covered. The maintenance coverage period is for the first 4 years or 50,000 miles, whichever comes first. Exclusions from coverage include: gasoline, gasoline additives, windshield washer fluid and additives, battery, tires, wheels, wheel alignment and tire balancing. All work must be performed by an authorized BMW center. See the Service and Warranty Information booklet for specific terms, conditions and limitations. Further information can also be obtained from your authorized BMW center.

⁴ Requires BMW Assist Safety Plan subscription. Services are subject to the terms and conditions of your subscriber agreement. Please go to bmwassist.com for additional details on the optional Convenience Plan.

⁵ Subject to credit approval and other terms and conditions.

⁶ Not all models available for BMW European Delivery Program. Please go to bmwusa.com or visit your authorized BMW center for details.

More about BMW



bmwusa.com
1-800-334-4BMW

The Ultimate
Driving Machine®

BMW and the environment.

BMW is a strong proponent of the environment and social responsibility. In 2000, we launched BMW EfficientDynamics – the philosophy of providing greater power with increased efficiency and fewer emissions. Today, this results in significant benefits to our customers, the climate and the environment.

Sustainability is firmly anchored in our entire production chain, from the development of fuel-saving and alternative vehicle concepts, through environmentally friendly production processes, to innovative recycling methods. This effort has been recognized worldwide, and we are pleased to have received numerous environmental honors. In the U.S., for example, the Environmental Protection Agency accepted BMW's Spartanburg, SC production and manufacturing facility as a charter member of the agency's National Environmental Performance Track. Internationally, BMW AG – the parent company of both BMW of North America and BMW Manufacturing Co., Spartanburg, SC – was the first automotive company to be represented on the Dow Jones Sustainability Group Index. It has remained on the Index ever since, and was voted the industry leader for a fifth consecutive year. At BMW, we strive for high performance in everything we do.

U.S. Importer: BMW of North America, LLC, Woodcliff Lake, NJ 07677. All illustrations and specifications contained in this brochure are based on the latest product information available at the time of printing. BMW reserves the right to make changes at any time, without notice, in colors, materials, equipment, specifications and models. BMW may, subject to legal requirements, determine the Model Year designation of its vehicles. The Model Year designation on any particular model may be longer or shorter than 12 months. Some vehicles pictured may contain non-U.S. equipment. Some models may be shown with optional equipment. While BMW NA makes all reasonable efforts to provide accurate information in this brochure, there is no guarantee or warranty of accuracy. Furthermore, we do not assume any liability for the accuracy or completeness of information presented. This brochure shall not be used or relied upon as a substitute for information that is available from your BMW center. Further information can be obtained from your authorized BMW center or bmwusa.com.

©2010 BMW of North America, LLC. Not to be reproduced wholly or in part without written permission of BMW NA. The BMW name, model names and logo are registered trademarks.

The Bluetooth word mark and logos are owned by the Bluetooth SIG, Inc. and any use of such marks by BMW is under license. iPhone and iPod are registered trademarks of Apple Inc. Other trademarks and trade names are the property of their respective owners.

BMW recommends 