

2008 BMW  
3 Series Sedan



The Ultimate  
Driving Machine®

328i  
328xi  
335i  
335xi





So athletic, they call it a sports sedan.



Two innovative engines –  
including a revolutionary  
twist on turbocharging.

Suspension of disbelief.





Fiercely protective of its owner.





















At the center of everything, there's driving joy.

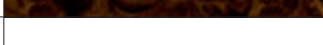
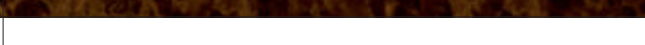

Clean, uncluttered and elegant.

## Recommended color combinations

Materials	Leatherette <sup>1</sup>		Dakota Leather <sup>2</sup>			
	Beige	Black	Beige	Gray	Terra	Black
<b>Upholstery colors</b>						
<b>Exterior colors</b>						
<b>300</b> Alpine White Non-metallic		•	•	•	•	•
<b>A61</b> Crimson Red Non-metallic		•	•	•		•
<b>668</b> Jet Black Non-metallic		•	•	•	•	•
<b>354</b> Titanium Silver Metallic <sup>3</sup>		•	•	•	•	•
<b>A53</b> Platinum Bronze Metallic <sup>3</sup>		•	•	•	•	•
<b>A34</b> Arctic Metallic <sup>3</sup>		•	•	•	•	•
<b>A22</b> Sparkling Graphite Metallic <sup>3</sup>		•	•	•	•	•
<b>A51</b> Montego Blue Metallic <sup>3</sup>		•	•	•	•	•
<b>A35</b> Monaco Blue Metallic <sup>3</sup>		•	•	•	•	•
<b>A39</b> Barbera Red Metallic <sup>3</sup>		•	•	•	•	•
<b>A43</b> Deep Green Metallic <sup>3</sup>		•	•	•	•	•
<b>475</b> Black Sapphire Metallic <sup>3</sup>		•	•	•	•	•
<b>Interior trims</b>						
<b>4AB</b> Dark Burl Walnut Wood <sup>4</sup>						
<b>4AC</b> Light Poplar Wood <sup>5</sup>						
<b>4AD</b> Brushed Aluminium <sup>5</sup>						

<sup>1</sup>Leatherette upholstery: Standard in 328i/328xi and 335i/335xi.

<sup>2</sup>Dakota Leather upholstery: Optional, and included in optional 328i/328xi and 335i/335xi Premium Packages.

<sup>3</sup>Metallic exterior paint is optional.

<sup>4</sup>Standard in 328i/328xi and 335i/335xi.

<sup>5</sup>No-cost options in 328i/328xi and 335i/335xi.

The pages in this section of the brochure show available colors and materials for the BMW 3 Series Sedan. Use these samples to compare paint, upholstery, trim colors and combinations. Please note that these samples are representations; they are not exact reproductions.

To see the actual colors, visit your local BMW center. They will be happy to show you original samples and assist you with special requests.



■ Standard equipment   □ Optional equipment



■ / □ **Xenon Adaptive Headlights** provide brilliant clarity of the road ahead and to the side at night and in conditions with poor visibility. The dynamic auto-leveling feature adjusts for varying passenger and cargo loads, helping to keep headlight glare out of the eyes of oncoming drivers. BMW Adaptive Headlights provide optimum road illumination around corners, thanks to an electromechanical control system that directs the headlights into and around the bend as soon as the vehicle begins cornering. (std. on 335i/335xi; opt. on 328i/328xi)



■ **Adaptive Brake Lights** increase vehicle visibility and signal the intensity of your braking action.



■ **Halogen free-form foglights**, integrated into the deep front spoiler, enhance your margin of safety in bad visibility. Ellipsoid free-form technology ensures even light distribution on the road.



■ BMW's **distinctive front kidney-shaped grille** features a chrome surround. The vertical slats on the 335i/335xi grille are chrome; the 328i/328xi has black slats.



■ **Roof rail clips and grooves** are designed for the BMW Accessory roof rail system, holding it perfectly in place.

■ Standard equipment    □ Optional equipment



□ **Star Spoke (Style 162) light alloy wheels and run-flat<sup>1</sup> performance tires.<sup>2</sup>** In front: 18 x 8.0 wheels and 225/40 tires; in back: 18 x 8.5 wheels and 255/35 tires.<sup>3</sup> (included in 335i Sport Package; opt. in 335xi, requires optional Sport Package)



■/□ **17 x 8.0 Star Spoke (Style 159) light alloy wheels with 225/45 run-flat<sup>1</sup> all-season tires.** (std. on 335i/335xi; included in 328xi Sport Package)



□ **17 x 8.0 Star Spoke (Style 158) light alloy wheels with 225/45 run-flat<sup>1</sup> all-season tires.** (included in 335xi Sport Package)



■ **16 x 7.0 Double Spoke (Style 268) light alloy wheels with 205/55 run-flat<sup>1</sup> all-season tires.** (std. on 328i/328xi)



□ **Double Spoke (Style 161) light alloy wheels and run-flat<sup>1</sup> performance tires.<sup>2</sup>** In front: 17 x 8.0 wheels and 225/45 tires; in back: 17 x 8.5 wheels and 255/40 tires.<sup>3</sup> (included in 328i Sport Package; opt. in 328xi, requires optional Sport Package)

<sup>1</sup> Run-flat tires do not come equipped with a spare tire.

<sup>2</sup> Performance tires not recommended for driving in ice and snow.

<sup>3</sup> Due to low-profile tires, wheels, tires and suspension parts are more susceptible to road hazard and consequential damages.

■ Standard equipment    □ Optional equipment



■ **Three-spoke leather-wrapped multi-function steering wheel** lets you keep both hands on the wheel while adjusting various comfort functions, such as changing the radio, CD selections and volume. Optional Voice Command (included with optional Navigation system) can be used to change radio stations and audio selection, Navigation system destinations, and voice dialing of the telephone.



□ **6-speed STEPTRONIC automatic** provides a choice of three modes: “Drive” with Adaptive Transmission Control; a more dynamic “Sport” mode; and STEPTRONIC automatic, for the hands-on control of a manual without a clutch.<sup>1</sup> (shown with iDrive, included with optional Navigation system)

<sup>1</sup> When both optional Sport Package and optional STEPTRONIC automatic transmission are ordered, optional paddle shifters are automatically added.



■ **6-speed manual transmission** delivers a precise, athletic feel. Its responsiveness is due, in part, to the enhanced synchronization of shifts from neutral to each gear. A shortened shift lever and “throw” add to the sporty feel of the gearbox. The sixth gear drops revs at highway speeds for smooth cruising. (shown with iDrive, included with optional Navigation system)



□ **Steering wheel-mounted paddle shifters** allow you to shift gears manually without using a clutch. This option is included in the 3 Series Sedan when equipped with the optional Sport Package and optional STEPTRONIC automatic transmission.



■ The **on-board computer** with Check Control provides valuable feedback on the vehicle’s operating status: oil level indicator and distance to next service appointment/oil change, as well as other detailed information, such as spark plug and micro-filter status. It also provides travel information – travel range on remaining fuel, external temperature, and more.



■ **Rain sensor** measures the amount of rain. In “intermittent” windshield wiper mode, it automatically adjusts the wiping interval as needed. Includes **automatic headlight control** (not shown), which activates headlights by means of a sensor that responds to darkness. The rain sensor is also integrated into the braking system as part of the Brake Drying feature.

■ Standard equipment    □ Optional equipment



■ **Engine Start/Stop button<sup>2</sup> and remote key** control the engine. First, insert the remote key into the starter switch slot. After the electronic identification system confirms that it is the correct remote key, you can start (or later, turn off) the engine by pressing the Start/Stop button.

<sup>2</sup> Foot must be on brake, or with manual transmission, must also depress the clutch, in order to start.



■ **Dynamic Cruise Control** lets you store and keep to a chosen speed above 20 mph, automatically applying the brakes downhill. It is activated via the left-hand steering column switch, and deactivated by applying the brakes or via the switch.<sup>3</sup>

<sup>3</sup> Cruise Control is not a substitute for the driver's own responsibility in adjusting speed and otherwise controlling the vehicle. Due to road, traffic and visibility conditions, the driver decides whether and how the system is used.



■ **Two-way power glass moonroof** with remote, expanded one-touch operation, slides forward or tilts up to let in as much fresh air and sky as you like, while a wind deflector helps keep the wind out. Includes a sliding interior sunshade.



■/□ **Logic7 Surround Sound** anti-theft AM/FM stereo CD/MP3 player audio system provides outstanding sound with 13 speakers and the adjustable surround sound function to create a luxurious soundscape all around you. The subwoofer speakers, located under the front seats, produce an authentic bass sound. (std. in 335i/335xi; opt. in 328i/328xi)



■ **Auxiliary input port** lets you connect an external audio source, such as an iPod® or MP3 player.

□ **iPod and USB adaptor** lets you scroll through and select the music you want by using the car's radio controls, the multi-function steering wheel buttons or iDrive Controller. Music titles are displayed on the radio or Navigation screen.

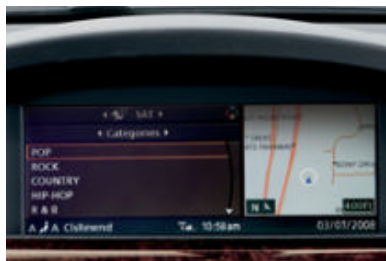

□ **SIRIUS Satellite Radio** provides commercial-free music, sports, news and entertainment, wherever you travel across the U.S. (Shown on optional Navigation system)



■ **BMW anti-theft AM/FM stereo CD/MP3 player** includes Radio Data System, Auto-Store, and 3-channel FM diversity antenna; reads/displays song title. Pre-wired for (accessory) BMW six-disc CD player/changer. □ **HD Radio™** receives free, digital AM/FM broadcasts in clear, static-free sound; multi-cast FM stations, and innovative data services. Can be ordered in combination with optional Logic7 Surround Sound audio system.

■ Standard equipment    □ Optional equipment



□ **Power sunshade for the rear window** can be raised and lowered at the press of a button. Together with manual sunshades for the rear side windows, this feature helps eliminate glare, maintains occupant privacy, and helps keep the cabin temperature pleasant by reflecting intense sunlight.



□ **BMW Assist™** and **Bluetooth®** system offers hands-free calling through your BMW-approved **Bluetooth** phone. BMW Assist Safety Plan includes Automatic Collision Notification, Enhanced Roadside Assistance, Remote Door Unlock, TeleService and more. Also available is an optional Convenience Plan with Directions and Weather information, Critical Calling and Concierge service.



□ **Park Distance Control** uses ultrasonic sensors in the rear bumper to help you judge the distance to other cars and unseen objects when parking. The beeping becomes faster as your bumper approaches the object, turning into a constant tone when the distance is less than 12 inches.



□ **Active Steering** adjusts the steering ratio in relation to vehicle speed. At lower to medium speeds, the steering is more direct; at higher speeds, the steering provides greater directional stability. (Not available in 328xi and 335xi)

■ Standard equipment    □ Optional equipment



□ **Active Cruise Control** allows the driver to set a desired speed that is automatically maintained in free-flowing traffic. However, as the 3 Series Sedan approaches a slower-moving vehicle ahead, a radar sensor in the front bumper alerts the system. Active Cruise Control will then act to match the speed of the slower vehicle, and remain a set distance behind, pre-selected by the driver. As soon as the lane ahead is clear, Active Cruise Control automatically returns the car to the set speed.<sup>2</sup>

<sup>2</sup> Active Cruise Control is not a substitute for the driver's own responsibility in adjusting speed and otherwise controlling the vehicle. After evaluating road, traffic and visibility conditions, the driver must decide whether and how the system is used.



□ **Comfort Access system** offers an even greater degree of convenience: keyless access to your car. Simply carrying the remote key in a pocket allows you to unlock the doors by touching the door handle. You can also turn the engine on or off by pressing the Start/Stop button<sup>3</sup> without first inserting the remote key.

<sup>3</sup>Foot must be on brake, or with manual transmission, must also depress the clutch, in order to start.

## Premium Package

Add immeasurably to the enjoyment of your 3 Series Sedan with the Premium Package. Eight-way power-adjustable<sup>1</sup> front seats, upholstered in supple Leather, offer the customized comfort of four-way lumbar support. At night you'll appreciate the enhanced visibility afforded by auto-dimming rear- and power-adjustable folding exterior side-view mirrors. BMW Assist™ offers roadgoing peace of mind, while **Bluetooth**® wireless technology lets you keep in touch without taking your eyes from the road. And the integrated three-button Universal garage-door opener takes the place of up to three separate remote-control devices, helping to eliminate clutter.

<sup>1</sup> Power-adjustable front seats standard in 335i/335xi.



**BMW Assist™** and **Bluetooth®** system offers hands-free calling through your BMW-approved **Bluetooth** phone. BMW Assist Safety Plan includes Automatic Collision Notification, Enhanced Roadside Assistance, and more. Also available is an optional Convenience Plan with Directions and Weather information, and Concierge service.



**Power-adjustable folding exterior side-view mirrors** automatically dim when reflecting bright lights, helping to eliminate glare when driving at night.



**Lumbar support** for front seats adds four-way adjustable comfort for the lower back. Lumbar support can be adjusted up/down and in/out.



**Luxurious Leather upholstery** cradles driver and passengers in soft gathered comfort. Durable and easy to maintain, a Leather interior adds elegance and refinement.



**BMW Universal garage-door opener** takes the place of up to three remote-control devices. It can activate remote functions outside the vehicle, such as garage-door openers or home-lighting systems.

## Cold Weather Package

Enjoy winter to the fullest with the Cold Weather Package. There's nothing like the feeling of quick-warming heated front seats on a cold morning, and the reassurance of clean, bright headlights<sup>3</sup> on a stormy night. Add the comfort of a rear center armrest and the convenience of 1/3-2/3 split, separately folding rear seats. And for those en route to the slopes, a ski bag neatly holds skis and ski poles.

<sup>3</sup> High-intensity headlight washers standard in 328xi and 335xi.



Retractable **high-intensity headlight washers** help keep lights clean of ice, mud, road salt and other coatings, for maximum road lighting and enhanced driving safety.



Through-the-trunk loading system with **split-folding lockable rear seats and ski bag** allows clean and secure transport of up to four pairs of skis and ski poles. When the ski bag is not extended, the center armrest can be left down for use or folded up to create a third seat.

# Sport Package

The Sport Package injects even greater excitement into every minute spent behind the three-spoke, leather-wrapped multi-function sport steering wheel.<sup>4</sup> Larger wheels and run-flat performance tires team up with the sport-tuned suspension<sup>5</sup> to grip corners with a vengeance. Specially bolstered sport seats cradle you comfortably over long distances, while holding you firmly in place during sporty driving maneuvers.

<sup>4</sup>When the 3 Series Sedan Sport Package and optional STEPTRONIC automatic transmission are ordered, optional steering wheel-mounted paddle shifters are automatically included.

<sup>5</sup>Sport suspension not available in 328xi and 335xi.



**Double Spoke (Style 161) light alloy wheels and run-flat<sup>6</sup> performance tires.<sup>7</sup>** In front: 17 x 8.0 wheels and 225/45 tires; in back: 17 x 8.5 wheels and 255/40 tires.<sup>8</sup> (included in 328i Sport Package; opt. in 328xi, requires optional Sport Package)



**Star Spoke (Style 162) light alloy wheels and run-flat<sup>6</sup> performance tires.<sup>7</sup>** In front: 18 x 8.0 wheels and 225/40 tires; in back: 18 x 8.5 wheels and 255/35 tires.<sup>8</sup> (included in 335i Sport Package; opt. in 335xi, requires optional Sport Package)



**17 x 8.0 Star Spoke (Style 159) light alloy wheels with 225/45 run-flat<sup>6</sup> all-season tires.** (included in 328xi Sport Package)



**17 x 8.0 Star Spoke (Style 158) light alloy wheels with 225/45 run-flat<sup>6</sup> all-season tires.** (included in 335xi Sport Package)

<sup>6</sup>Run-flat tires do not come equipped with spare tire.

<sup>7</sup>Performance tires not recommended for driving in ice and snow.

<sup>8</sup>Due to low-profile tires, wheels, tires and suspension parts are more susceptible to road hazard and consequential damages.



**Three-spoke, leather-wrapped multi-function sport steering wheel** lets you keep both hands on the wheel while adjusting various comfort functions, such as changing the radio, CD selections and volume. Optional Voice Command (included with optional Navigation system) can be used to change radio stations and audio selection, Navigation system destinations, and (accessory) telephone entries. (shown with optional paddle shifters)



**Eight-way adjustable front sport seats** make the driving experience more enjoyable. Side bolsters can be power-adjusted to fit your back comfortably while helping to hold you firmly in place during cornering. (Eight-way power front sport seats with two-way manual headrests and thigh support: std. in 335i/335xi with Sport Package; opt. or included with Premium Package in 328i/328xi with Sport Package)



Performance and efficiency	328i	328xi	335i	335xi
3.0-liter dual overhead cam (DOHC), 24-valve inline 230-horsepower 6-cylinder engine with composite magnesium/aluminum engine block, Valvetronic, and Double-VANOS steplessly variable valve timing	●	●		
3.0-liter dual overhead cam (DOHC), 24-valve inline turbocharged 300-horsepower 6-cylinder engine with twin-turbo technology, piezo direct injection, and Double-VANOS steplessly variable valve timing			●	●
Electronic throttle control	●	●	●	●
6-speed manual transmission	●	●	●	●
6-speed STEPTRONIC automatic transmission with Adaptive Transmission Control	○	○	○	○
Steering wheel-mounted paddle shifters <sup>1</sup>	○	○	○	○

Handling, ride and braking	328i	328xi	335i	335xi
Dynamic Stability Control (DSC), including Brake Fade Compensation, Start-off Assistant, Brake Drying, and Brake Stand-by features, with Dynamic Traction Control (DTC)	●	●	●	●
Extensive aluminum componentry, including front suspension components (forged-aluminum lower arms, steering knuckle); subframe; steering rack; and brake components	●		●	
xDrive all-wheel-drive system		●		●
Hill Descent Control		●		●
Double-pivot type front suspension with dual forged-aluminum lower arms	●	● <sup>2</sup>	●	● <sup>2</sup>
5-link rear suspension with cast-aluminum upper transverse arms	●	●	●	●
Front and rear anti-roll (stabilizer) bars	●	●	●	●
Twin-tube gas-pressure shock absorbers	●	●	●	●
4-wheel ventilated anti-lock disc brakes with Dynamic Brake Control (DBC)	●	●	●	●
Engine-speed-sensitive, variable-assist power steering	●	●	●	●
Active Steering with Servotronic power assist	○		○	
Sport suspension calibration	□		□	

Exterior	328i	328xi	335i	335xi
16 x 7.0 Double Spoke (Style 268) light alloy wheels, 205/55 run-flat <sup>3</sup> all-season tires	●	●		
17 x 8.0 Star Spoke (Style 159) light alloy wheels, 225/45 run-flat <sup>3</sup> all-season tires		□	●	●
Double Spoke (Style 161) light alloy wheels, 17 x 8.0 front, 17 x 8.5 rear; 225/45 front, 255/40 rear run-flat <sup>3</sup> performance tires <sup>4</sup>	□	○ <sup>5</sup>		
17 x 8.0 Star Spoke (Style 158) light alloy wheels, 225/45 run-flat <sup>3</sup> all-season tires				□
Star Spoke (Style 162) light alloy wheels, 18 x 8.0 front, 18 x 8.5 rear; 225/40 front, 255/35 rear run-flat <sup>3</sup> performance tires <sup>4</sup>			□	○ <sup>5</sup>
Tire Pressure Monitor	●	●	●	●
Halogen high- and low-beam headlights	●	●		
Xenon Adaptive Headlights with auto-leveling	○	○	●	●
Halogen free-form front foglights	●	●	●	●
Retractable, high-intensity headlight washers	★	●	★	●
Heated dual power mirrors and heated windshield washer jets	●	●	●	●
Chrome-plated exhaust tips	●	●	●	●
Metallic paint	○	○	○	○

- Standard
- Optional
- Included in optional Sport Package
- ◇ Included in optional Premium Package
- ★ Included in optional Cold Weather Package

<sup>1</sup> Requires and is automatically included with optional Sport Package and optional STEPTRONIC automatic transmission.

<sup>2</sup> 328xi and 335xi have steel lower arms and a steel subframe, plus an aluminum thrust plate.

<sup>3</sup> Run-flat tires do not come equipped with spare tire.

<sup>4</sup> Due to low-profile tires, please note: wheels, tires and suspension parts are more susceptible to road hazard and consequential damages. Performance tires are not recommended for driving in snow and ice.

<sup>5</sup> Sport Package required.

Interior seating	328i	328xi	335i	335xi
8-way adjustable front seats (includes 2-way headrests)	●	●		
8-way power front seats with 2-way manual headrests and driver memory with 2 pre-sets for exterior mirror and seat positions	○/◇	○/◇	●	●
8-way manual adjustable front sport seats with adjustable back bolsters, and 2-way headrests and thigh support	□	□		
8-way power front sport seats with adjustable back bolsters, 2-way manual headrests and thigh support; driver memory for exterior mirror and seat positions	□ <sup>6</sup>	□ <sup>6</sup>	□	□
4-way adjustable power lumbar support for front seats	◇	◇	◇	◇
Leatherette upholstery	●	●	●	●
Leather upholstery	○/◇	○/◇	○/◇	○/◇
3-stage heated front seats	○/★	○/★	○/★	○/★
3-spoke leather-wrapped multi-function steering wheel with audio and Bluetooth <sup>®</sup> phone <sup>7</sup> controls	●	●	●	●
3-spoke leather-wrapped multi-function sport steering wheel with audio and Bluetooth phone <sup>7</sup> controls	□	□	□	□
Front seatback storage nets	●	●	●	●
Split fold-down through-load rear seats and ski bag	○/★	○/★	○/★	○/★
Dark Burl Walnut Wood trim	●	●	●	●
Light Poplar Wood trim <sup>8</sup>	○	○	○	○
Brushed Aluminum interior trim <sup>8</sup>	○	○	○	○

Audio system	328i	328xi	335i	335xi
Anti-theft AM/FM stereo CD/MP3 player audio system with 10 speakers (including 2 subwoofers), Radio Data System (RDS), Auto-Store and 3-channel FM diversity antenna; displays MP3 song title and artist	●	●		
Logic7 Surround Sound anti-theft AM/FM stereo CD/MP3 player audio system with 13 upgraded speakers (including 2 subwoofers), Digital Sound Processing (DSP), Radio Data System (RDS), Auto-Store and 3-channel FM diversity antenna; displays MP3 song title and artist	○	○	●	●
Auxiliary audio input for portable music players	●	●	●	●
Pre-wiring for BMW center installation of 6-disc CD/MP3 changer	●	●	●	●
SIRIUS Satellite Radio with one-year subscription <sup>9</sup>	○	○	○	○
Pre-wiring for BMW center installation of SIRIUS Satellite Radio <sup>9</sup>	○	○	○	○
iPod <sup>®</sup> and USB adaptor (includes cable connector)	○	○	○	○
HD Radio™ with "multicast" FM station reception	○	○	○	○

- Standard
- Optional
- Included in optional Sport Package
- ◇ Included in optional Premium Package
- ★ Included in optional Cold Weather Package

<sup>6</sup> Optional power seats or Premium Package required.

<sup>7</sup> If so equipped.

<sup>8</sup> No-cost option.

<sup>9</sup> Pre-wiring required for SIRIUS Satellite Radio.

Please visit your authorized BMW center for details on equipment.

Comfort and convenience	328i	328xi	335i	335xi
Engine Start/Stop button	●	●	●	●
Advanced Vehicle & Key Memory – includes climate-control temperature and air-distribution settings, exterior mirror and power seat settings, <sup>10</sup> audio tone settings and radio pre-sets with optional Navigation system, central-locking preferences, and lighting preferences	●	●	●	●
Comfort Access keyless entry with multi-function remote control	○	○	○	○
Automatic climate control – includes micro-filter, automatic air recirculation, left/right temperature control, temperature- and volume-controlled rear outlets, windshield misting sensor, MAX A/C function, heat at rest, more powerful fan, and recall of individual user settings	●	●	●	●
2-way power glass moonroof with “one-touch” operation, sliding interior sunshade, and wind deflector	●	●	●	●
Front-seat center armrest with climate-controlled storage compartment	●	●	●	●
Front passenger cupholders (dashboard-integrated)	●	●	●	●
Rear-seat center armrest with cupholders	●	●	●	●
Tilt/telescopic steering wheel column	●	●	●	●
Park Distance Control (PDC) (rear only)	○	○	○	○
Interior and power-adjustable folding exterior mirrors with auto-dimming function; digital compass	◇	◇	◇	◇
Power front and rear windows with “one-touch” up/down operation	●	●	●	●
Power rear sunshade; manual rear side window shades	○	○	○	○
Dynamic Cruise Control	●	●	●	●
Active Cruise Control	○	○	○	○
BMW Ambiance Lighting front and rear	●	●	●	●
Courtesy lights – include fade in/fade out, actuation from remote, automatic switch-on when engine is turned off, separately controlled left/right front and rear reading lights, front footwell lighting, and illuminated vanity mirrors	●	●	●	●
Ground-illuminating lights in door handles	●	●	●	●
Locking glovebox	●	●	●	●
Electric interior trunk release	●	●	●	●
Rain-sensing windshield wipers and Automatic headlight control	●	●	●	●
Integrated 3-button Universal garage-door opener	◇	◇	◇	◇
<b>Bluetooth</b> <sup>®</sup> wireless technology <sup>11</sup> for hands-free calling, capable of downloading virtually an entire phonebook using BMW-approved <b>Bluetooth</b> technology enabled mobile phones <sup>12</sup>	○/◇	○/◇	○/◇	○/◇
Pre-wiring for BMW center installation of mobile phone, alarm system	●	●	●	●

Instrumentation and controls	328i	328xi	335i	335xi
Service Interval Indicator with miles-to-service readout	●	●	●	●
Check Control vehicle monitor system with pictogram display, oil status display, and Condition Based Service indicator	●	●	●	●
On-board computer with Check Control – provides feedback on the vehicle’s operating status: oil level indicator and distance to next service appointment/oil change, as well as other detailed information, such as spark plug and micro-filter status. It also provides travel information – travel range on remaining fuel, external temperature and more	●	●	●	●
BMW Navigation system with 16:9 screen and Voice Command system with Real Time Traffic Information; iDrive system with high-function on-board computer and controller, and 6 programmable memory keys	○	○	○	○

- Standard
- Optional
- Included in optional Sport Package
- ◇ Included in optional Premium Package
- ★ Included in optional Cold Weather Package

<sup>10</sup> Optional and included in 328i/328xi Premium Package; standard in 335i/335xi.

<sup>11</sup> Included with Premium Package or BMW Assist.™

<sup>12</sup> Please contact your authorized BMW center for a list of BMW-approved **Bluetooth** technology enabled mobile phones.

<b>Safety and security</b>	<b>328i</b>	<b>328xi</b>	<b>335i</b>	<b>335xi</b>
Anti-lock braking system (ABS)	●	●	●	●
Adaptive Brake Lights	●	●	●	●
BMW's Advanced Safety System for integrated deployment of passive and active safety features	●	●	●	●
Front and rear Head Protection System (HPS)	●	●	●	●
Driver's and passenger's front airbag supplemental restraint system (SRS) with advanced technology: dual-threshold, dual-stage deployment; and front-passenger seat sensors designed to prevent unnecessary airbag deployment	●	●	●	●
Seat-mounted front side-impact airbags	●	●	●	●
Automatic safety-belt pretensioners at front and rear outboard seating positions	●	●	●	●
Front passenger seat-occupation recognition with Passenger's Airbag Off indicator	●	●	●	●
Interlocking door anchoring system to help protect against door intrusion in side impacts	●	●	●	●
Central locking system with center console switch (leaves gas filler door unlocked), double-lock feature and 2-step unlocking	●	●	●	●
Coded Driveaway Protection	●	●	●	●
Automatic-locking retractors (ALR) on all passenger safety belts for installation of child-restraint seat	●	●	●	●
LATCH attachments on child-restraint safety installation	●	●	●	●
Crash sensor that automatically turns on hazard lights and interior lights, and unlocks doors	●	●	●	●
Programmable Daytime Running Lights	●	●	●	●
Fiber-optics-based MOST-Bus architecture for safety systems <sup>13</sup>	●	●	●	●
BMW Assist™ with <b>Bluetooth</b> ® wireless technology for hands-free calling (with <b>Bluetooth</b> enabled mobile phone), phonebook downloading and speech recognition capabilities	○/◇	○/◇	○/◇	○/◇

<b>BMW Services</b>	<b>328i</b>	<b>328xi</b>	<b>335i</b>	<b>335xi</b>
BMW Ultimate Service™	●	●	●	●

- Standard
- Optional
- Included in optional Sport Package
- ◇ Included in optional Premium Package
- ★ Included in optional Cold Weather Package

<sup>13</sup> MOST-Bus is a fiber-optic system responsible for transmitting digital audio and graphics signals/information.

Premium Packages	328i	328xi	335i	335xi
8-way power front seats with 2-way manual headrests and driver memory for exterior mirror and seat positions	○/◇	○/◇	●	●
4-way adjustable power lumbar support for front seats	◇	◇	◇	◇
Leather upholstery	○/◇	○/◇	○/◇	○/◇
Interior and power-adjustable folding exterior mirrors with automatic-dimming function; digital compass	◇	◇	◇	◇
Integrated 3-button Universal garage-door opener	◇	◇	◇	◇
BMW Assist™ with Bluetooth® wireless technology for hands-free calling (with Bluetooth enabled mobile phone), phonebook downloading and speech recognition capabilities	○/◇	○/◇	○/◇	○/◇

Sport Packages	328i	328xi	335i	335xi
Double Spoke (Style 161) light alloy wheels, 17 x 8.0 front, 17 x 8.5 rear; 225/45 front, 255/40 rear run-flat <sup>17</sup> performance tires <sup>18</sup>	□	○ <sup>19</sup>		
17 x 8.0 Star Spoke (Style 159) light alloy wheels, 225/45 run-flat <sup>17</sup> all-season tires		□		
Star Spoke (Style 162) light alloy wheels, 18 x 8.0 front, 18 x 8.5 rear; 225/40 front, 255/35 rear run-flat <sup>17</sup> performance tires <sup>18</sup>			□	○ <sup>19</sup>
17 x 8.0 Star Spoke (Style 158) light alloy wheels, 225/45 run-flat <sup>17</sup> all-season tires				□
8-way manual adjustable front sport seats with adjustable back bolsters, and 2-way headrests and thigh support	□	□		
8-way power front sport seats with adjustable back bolsters, 2-way manual headrests and thigh support; driver memory for exterior mirror and seat positions	□ <sup>20</sup>	□ <sup>20</sup>	□	□
3-spoke leather-wrapped multi-function sport steering wheel with audio controls	□	□	□	□
Sport suspension calibration	□		□	
Steering wheel-mounted paddle shifters <sup>21</sup>	○	○	○	○

Cold Weather Package	328i	328xi	335i	335xi
3-stage heated front seats	○/★	○/★	○/★	○/★
Split fold-down through-load rear seats and ski bag	○/★	○/★	○/★	○/★
Retractable, high-intensity headlight washers	★	●	★	●

- Standard
- Optional
- Included in optional Sport Package
- ◇ Included in optional Premium Package
- ★ Included in optional Cold Weather Package

<sup>17</sup>Run-flat tires do not come equipped with spare tire.

<sup>18</sup>Due to low-profile tires, please note: wheels, tires and suspension parts are more susceptible to road hazard and consequential damages. Performance tires are not recommended for driving in snow and ice.

<sup>19</sup>Sport Package required.

<sup>20</sup>Optional power seats or Premium Package required; Sport Package also required.

<sup>21</sup>Requires and is automatically included with optional Sport Package and optional STEPTRONIC automatic transmission.

<b>Weight</b>		<b>328i</b>	<b>328xi</b>	<b>335i</b>	<b>335xi</b>
Unladen	lbs	3340 (3406)	3582 (3627)	3594 (3605)	3814 (3825)
Weight distribution, front/rear					
Manual transmission	%	50.5/49.5	52.6/47.4	51.5/48.5	53.8/46.2
Automatic transmission	%	51.1/48.9	52.9/47.1	51.7/48.3	53.9/46.1

<b>Engine</b>		<b>328i</b>	<b>328xi</b>	<b>335i</b>	<b>335xi</b>
Liter/type		3.0/inline 6	3.0/inline 6	3.0/inline 6	3.0/inline 6
Bore/stroke	inch	3.35/3.46	3.35/3.46	3.31/3.53	3.31/3.53
Nominal output/rpm	hp	230/6500	230/6500	300/5800	300/5800
Maximum torque/rpm	lb-ft	200/2750	200/2750	300/1400-5000	300/1400-5000
Compression ratio	:1	10.7	10.7	10.2	10.2
Fuel grade		unleaded premium	unleaded premium	unleaded premium	unleaded premium

<b>Transmission</b>		<b>328i</b>	<b>328xi</b>	<b>335i</b>	<b>335xi</b>
Manual gear ratios					
I/II	:1	4.32/2.46	4.32/2.46	4.06/2.40	4.06/2.40
III/IV	:1	1.66/1.23	1.66/1.23	1.58/1.19	1.58/1.19
V/VI/R	:1	1.00/0.85/3.94	1.00/0.85/3.93	1.00/0.87/3.68	1.00/0.87/3.68
Final drive ratio	:1	3.23	3.39	3.08	3.08
Automatic gear ratio					
I/II	:1	4.07/2.37	4.07/2.37	4.17/2.34	4.17/2.34
III/IV	:1	1.55/1.16	1.55/1.16	1.52/1.14	1.52/1.14
V/VI/R	:1	0.85/0.67/3.20	0.85/0.67/3.20	0.87/0.69/3.40	0.87/0.69/3.40
Final drive ratio	:1	3.73	3.91	3.46	3.46

Figures in ( ) apply to vehicles with automatic transmission.

<b>Performance</b>		<b>328i</b>	<b>328xi</b>	<b>335i</b>	<b>335xi</b>
Drag coefficient	C <sub>d</sub>	0.30	0.31	0.30	0.31
Top speed <sup>1</sup>	mph	130 [150]	130 [150] ([150])	130 [150]	130 [150] ([150])
Acceleration 0-60 mph <sup>2</sup>					
Manual transmission	sec	6.3	6.9	5.4	5.3
Automatic transmission	sec	6.9	7.1	5.6	5.4

<b>Fuel consumption<sup>3</sup></b>		<b>328i</b>	<b>328xi</b>	<b>335i</b>	<b>335xi</b>
Manual transmission – City/Highway	mpg	18/28	17/25	17/26	16/25
Automatic transmission – City/Highway	mpg	19/28	17/25	17/26	17/25

<b>Tires and wheels</b>		<b>328i</b>	<b>328xi</b>	<b>335i</b>	<b>335xi</b>
Tire dimensions	standard	205/55	205/55	225/45	225/45
Wheel dimensions	standard	16 x 7.0	16 x 7.0	17 x 8.0	17 x 8.0
Material	standard	light alloy	light alloy	light alloy	light alloy

<b>Brakes</b>		<b>328i</b>	<b>328xi</b>	<b>335i</b>	<b>335xi</b>
Front – diameter	inch	12.3	12.3	13.7	13.7
Rear – diameter	inch	11.8	11.8	13.2	13.2

Figures in [ ] apply to vehicles with Sport Package.

Figures in ( ) apply to vehicles with automatic transmission.

<sup>1</sup> Top speed limited electronically.

<sup>2</sup> BMW AG test results. Actual acceleration results may vary, depending on specification of vehicle; road and environmental conditions; testing procedures and driving style. These results should be used for comparison only and verification should not be attempted on public roads.

**BMW urges you to obey all posted speed laws and always wear safety belts.**

<sup>3</sup> EPA-estimated figures are for comparison purposes only. Your actual mileage will vary, depending on speed, driving habits, trip length and driving conditions; actual mileage may be lower.

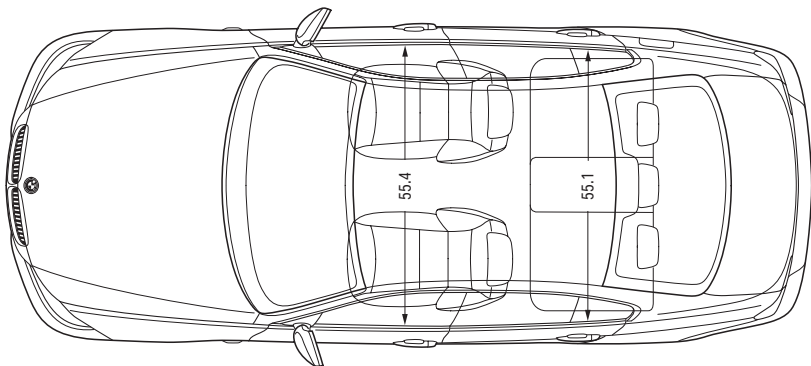
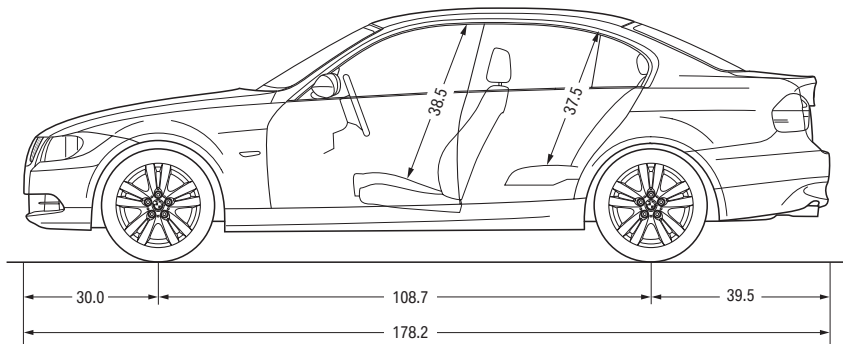
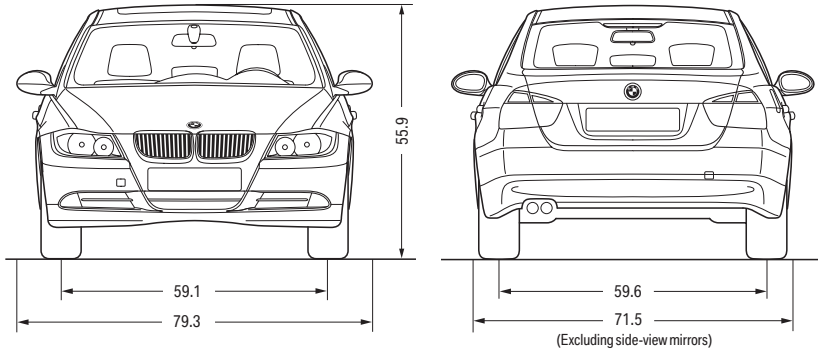

All dimensions are shown in inches.



More about BMW



bmwusa.com  
1-800-334-4BMW

The Ultimate  
Driving Machine®

### BMW and the environment.

BMW is a strong proponent of the environment and social responsibility. It is important to manage the earth's resources responsibly, and not jeopardize the needs of future generations. That is why BMW makes vehicles that minimize adverse environmental impact, from production (pollution prevention and waste minimization at the plant) through owner use (low emissions) to eventual disposal (easy drainability of all fluid-related components and easy neutralization of all pyrotechnic devices).

This effort has been recognized worldwide and, as a result, we are pleased to have received numerous environmental honors. In the U.S., for example, the Environmental Protection Agency accepted BMW's Spartanburg, SC production and manufacturing facility as a charter member of the agency's National Environmental Performance Track. Internationally, BMW AG – the parent company of both BMW of North America and BMW Manufacturing Co., Spartanburg, SC – was the first automotive company to be represented on the Dow Jones Sustainability Group Index, and has remained on the Index ever since. At BMW, we strive for high performance in everything we do.

U.S. Importer: BMW of North America, LLC, Woodcliff Lake, NJ 07677. All illustrations and specifications contained in this brochure are based on the latest product information available at the time of printing. BMW reserves the right to make changes at any time, without notice, in colors, materials, equipment, specifications and models. BMW may, subject to legal requirements, determine the Model Year designation of its vehicles. The Model Year designation on any particular model may be longer or shorter than 12 months. Some vehicles pictured may contain non-U.S. equipment. Some models may be shown with optional equipment. While BMW NA makes diligent efforts to provide accurate information in this brochure, there is no guarantee or warranty of accuracy. Furthermore, we do not assume any liability for the accuracy or completeness of information presented. This brochure shall not be used or relied upon as a substitute for information that is available from your BMW center. Further information can be obtained from your authorized BMW center or [bmwusa.com](http://bmwusa.com).

©2008 BMW of North America, LLC. Not to be reproduced wholly or in part without written permission of BMW NA. The BMW name, model names and logo are registered trademarks.

The **Bluetooth** word mark and logos are owned by the **Bluetooth SIG, Inc.** and any use of such marks by BMW is under license. iPod is a registered trademark of Apple Inc. Other trademarks and trade names are the property of their respective owners.

BMW recommends 

