

**BMW  
5 Series Sedan**  
520i  
528i xDrive  
535i  
535i xDrive  
550i  
550i xDrive  
ActiveHybrid 5



# THE 5 SERIES SEDAN.

A CELEBRATION OF BEAUTY AND POWER.

**BMW EfficientDynamics**  
Less emissions. More driving pleasure.

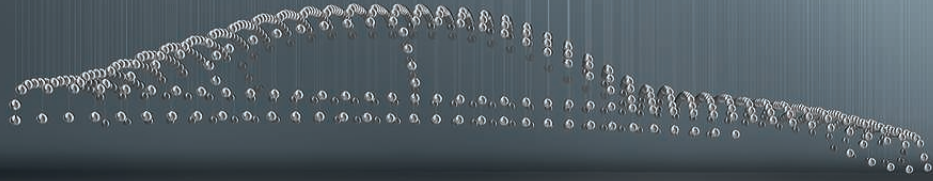

# POWER AND PLEASURE. ALL IN PERFECT BALANCE.

The BMW 5 Series Sedan: the perfect symbiosis of modern design and driving pleasure. It's our tribute to the beauty of ideas – the lifeblood of our company. Whether in the grand sweep of an eye-catching contour, or in the rigid, lightweight construction of the suspension, innovative ideas keep every inch of the BMW 5 Series Sedan moving forward. And with over 90 years of creating vehicles designed to stay at the forefront of the industry, we know a thing or two about the beauty and joy of driving.



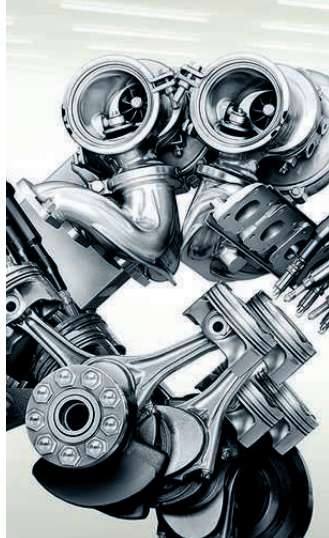

## The BMW 5 Series Sedan

### AESTHETIC MEETS ATHLETIC.

- 06 Exterior**  
The shape of perfection.
- 10 Driving experience**  
Highlights of the BMW 5 Series Sedan.
- 20 Dynamics and design**  
Interview with chief designer Adrian van Hooydonk.
- 22 Interior**  
Cockpit and rear-cabin highlights.
- 26 Experience**  
Five minutes in the BMW 5 Series Sedan.

[bmwusa.com/5series](http://bmwusa.com/5series)

## Technology

### LATEST REVELATIONS ON REVOLUTIONS.

- 28 Performance**  
The BMW 5 Series Sedan on the move.
- 30 BMW EfficientDynamics**  
Technology that increases excitement and reduces fuel consumption and emissions.
- 32 Engines**  
Three TwinPower Turbo engines.
- 34 BMW ActiveHybrid 5**  
Luxury meets exhilarating hybrid power.
- 36 Chassis and safety features**  
Innovations that inspire confidence.
- 38 BMW ConnectedDrive**  
Systems that add convenience and peace of mind while you're on the road.
- 42 Six technical questions**  
Explaining six interesting technologies in the BMW 5 Series Sedan.

[bmwusa.com/technology](http://bmwusa.com/technology)

## Equipment

### ONE OF A KIND, ONE AT A TIME.

- 44 Combination examples**
- 46 BMW M Sport Package**
- 48 BMW Individual**
- 50 Exterior colors**
- 51 Upholstery materials and colors**
- 52 Interior trims**
- 53 Recommended color combinations**
- 54 Equipment features and options**
- 62 Original BMW Accessories**  
World-class, yet personalizing.
- 63 Build Your Own**

[bmwusa.com/byo](http://bmwusa.com/byo)

## Overview

### SPECIFICATIONS AND SERVICES.

- 64 Technical data**
- 66 BMW Services**  
Exclusive offers for BMW customers.

[bmwusa.com](http://bmwusa.com)



Want the inside scoop on BMW? You can find us on Facebook® at [facebook.com/bmwusa](https://www.facebook.com/bmwusa).

#### Equipment of model shown: BMW 535i Sedan

Engine: 24-valve BMW TwinPower Turbo 3.0-liter inline six-cylinder engine  
 Nominal output: 300 hp @ 5800 rpm  
 Wheels: Radial Spoke (Style 237) 18-inch light alloy  
 Exterior color: Space Gray Metallic  
 Upholstery: Venetian Beige Dakota Leather  
 Interior trim: Anthracite Wood  
 Optional equipment: Premium Package, 8-speed Sport Automatic transmission, four-zone climate control

For information on specifications please see pages 64-65.

## Editorial

# A MASTER CLASS IN MOTION.

The art of design.

At the BMW Museum in Munich, there is a kinetic sculpture that immediately catches the eye with its complexity and beauty. No less than 714 metal balls continually align and then realign themselves in ever-shifting patterns – some abstract, some in the familiar contours of a BMW vehicle. The sculpture serves as a perfect representation of our approach to design: it is this same fluid concept of beauty that we apply to our vehicles, even from the earliest stages. And like the sculpture, each component of our design concept must be in place in order to create a cohesive, unified whole.

The BMW 5 Series Sedan – a winning combination of elegance, sportiness and luxury – captures this principle beautifully. With its timeless profile with contours that impress, the gracefully chiseled body of the BMW 5 Series expresses the essence of BMW design. But it is not simply a superficial attraction. You'll find equal attention to detail has been paid to the entire vehicle. Under the hood are dynamic, fuel-efficient TwinPower Turbo engines, including the dynamic hybrid powerplant in the BMW ActiveHybrid 5. The cabin serves as a master class in functional comfort, from the Black Panel Display technology that awakens to glowing life at the press of the Start button, to the Parking Assistant feature that selects and then helps pilot you into parking spaces. The 5 Series can also be lavished with the exquisite paint finishes, sumptuous Extended Merino Leather upholstery and rich interior trims of BMW Individual Composition.

Each of these aspects is compelling on its own. Incorporated into a single, symphonic whole, the result is no less than class-leading. The BMW 5 Series Sedan resets the standards. It's a difference that rewards drivers, passengers and onlookers alike.



# AESTHETICS

BMW 5 Series Sedan design and style: both answer any questions about how we see the world of automotive beauty. From the powerful front end, to the expressive contours, to the signature Hofmeister kink, each eye-catching section is also a vital component in the dynamic, elegant symphony of the vehicle's exterior. And if your question is, does it drive the way it looks? The answer is a resounding yes.

[bmwusa.com/5series](http://bmwusa.com/5series)

06 07 Exterior









**THE PURSUIT OF  
HAPPINESS IS  
NEVER-ENDING.**

Elegance and efficiency, sophistication and swagger: the BMW 5 Series Sedan gives drivers and passengers a sense of purpose on the road – and a reason to keep moving.



# DYNAMIC.





## BMW EFFICIENT DYNAMICS: THE LANGUAGE OF BMW ENGINEERING.

BMW EfficientDynamics has kept us moving toward one constant goal: our unwavering commitment to achieving maximum power and efficiency with minimum emissions. This compels us to create the most efficient models possible – from powerful, lightweight engines to aerodynamic tail ends, and every part in between. For example, our Brake Energy Regeneration technology harnesses the kinetic energy normally wasted when coasting and stopping. This energy is stored in the vehicle's battery, where it is available for running electrical components. As a result, the engine does less work, saving fuel and reducing emissions. It's just one more way BMW is moving forward to make driving as enjoyable and efficient as possible.

[bmwusa.com/efficientdynamics](http://bmwusa.com/efficientdynamics)

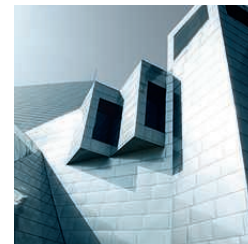



In crafting a perfectly balanced model of power, the engine is at the heart of the issue. With three TwinPower Turbo engine choices – a four-cylinder, six-cylinder and V-8 – and the ActiveHybrid 5, which combines a six-cylinder engine and an electric motor – the BMW 5 Series Sedan offers classic pulse-raising BMW performance. A 6-speed manual and two 8-speed automatic transmissions harness this power perfectly. Additionally, the 8-speed transmissions provide enhanced fuel efficiency. It's the most thrilling way to take flight.



**OUR DREAMS MOVE US.  
THEY'LL MOVE YOU, TOO.**

Get the latest information on BMW standard and optional features, packages and technical specifications. Visit [bmwusa.com](http://bmwusa.com), select the BMW model of your choice, and click on "Features & Specs."



BMW driving assistance technologies give important feedback on your vehicle's operating status and surrounding traffic.

**Full-color Head-up Display.**

Key information is projected directly into your field of vision so you can focus on the road ahead while staying informed of your speed and operating data. View Active Cruise Control data, Speed Limit Info, Navigation directions, BMW Night Vision with Pedestrian Detection Warning, and Lane Departure Warning system alerts.

**Active Cruise Control<sup>1</sup> with Stop & Go function.**

This feature uses radar measurements to automatically maintain a preset speed and distance between your vehicle and the one ahead in heavy traffic and highway driving. It can even bring your BMW to a stop, if needed. Once traffic allows, your BMW automatically returns to its preset speed. At all times, the Forward Collision Warning feature sounds an alert if you are approaching the vehicle ahead too quickly.

**Lane Departure Warning<sup>2</sup> and Active Blind Spot Detection.**

If your vehicle crosses the lane markings without first using the directional signal, the Lane Departure Warning system gently vibrates the steering wheel, alerting you; this feature also includes Frontal Collision Warning. The Active Blind Spot Detection feature continuously monitors for vehicles in your blind spot or that are approaching at a higher speed in the passing lane. If the directional signal is activated when another vehicle is present, a mild vibration is sent through the steering wheel and a visible image is displayed in the side-view mirror to alert you.

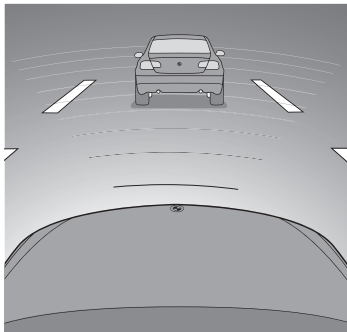

## TECHNOLOGY AT YOUR SERVICE: ADVANCED DRIVING ASSISTANCE SYSTEMS.

Get the latest information on BMW standard and optional features, packages and technical specifications. Visit [bmwusa.com](http://bmwusa.com), select the BMW model of your choice, and click on "Features & Specs."

<sup>1</sup> Cruise control is not a substitute for the driver's own responsibility in adjusting speed and otherwise controlling the vehicle. After evaluating the road, traffic and visibility conditions, the driver must decide whether and how the system is used.

<sup>2</sup> Requires clearly definable lane markings that are not obscured by rain, snow, etc. Lane Departure Warning feature is not a substitute for the driver's own responsibility in maintaining safe control of the vehicle.





At BMW, bold artistic statements are reinforced in even the smallest details. In this case, numerous supporting technologies help you make the most out of every ounce of this masterpiece's power and grace. Take, for example, BMW's Electric Power Steering (EPS). Enhancing both precision and comfort, the EPS system relies on an electric motor, as opposed to conventional mechanical systems, to provide assistance during steering maneuvers on an as-needed basis only. Once steering wheel movement ceases, such as when cruising, energy consumption from this innovative system is reduced to zero. So you can drive exactly as you intend – with poise and precision.



# A BMW SHOULD ALWAYS RADIATE DYNAMISM.

**Adrian van Hooydonk, Head of BMW Group Design, invited us to join him on an exclusive test drive. An interview with the expert about the design of the BMW 5 Series Sedan.**

Interview: Jan-Kirsten Biener  
Captions: Brian Finally



Exterior designer Jacek Fröhlich gets to work on his design model.

**Adrian van Hooydonk, what do you personally find so special about the BMW 5 Series Sedan?** This BMW 5 Series reveals at a glance exactly what you can expect to experience inside. It's the perfect fit, like a suit that's made to order – and the BMW 5 Series suits any occasion. No matter if you're on business, on vacation or driving around town, you're always dressed right, with a sure sense of style.

**At BMW, the 5 Series invariably has a special part to play. How do you see the role of this series in the current BMW portfolio?** The 5 Series is the brand's core product. The BMW 5 Series Sedan has the longest pedigree in the range and, for that reason alone, it holds a special place in our corporate history. As always, this BMW 5 Series demonstrates the perfect combination of sportiness and elegance.



Adrian van Hooydonk, Head of BMW Group Design, describes the BMW 5 Series Sedan.

**Were these the two primary characteristics you were after in your design?** Let's say that's why the design of the BMW 5 Series features very dynamic lines at the front and rear, while the side view has a stretched and timeless look to it.

**The way we see it, you've implemented three design concepts in a single car. Would you agree?** The observer always sees a car as a whole. Every BMW expresses a high degree of sportiness and elegance, with the mixture varying from one series to the next. For me, the BMW 5 Series is the epitome of the sporty business sedan. While it clearly belongs to the large sedan class, at the same time it has its own distinctive looks, based on the three primary characteristics that you referred to: the charismatic appeal of the front end, the stylish elegance of the side view, and the natural, authentic sportiness of the rear. Those were indeed the specifications for this model, and I'd say they're all readily identifiable in the finished product.

Interior designer Oliver Heimer checking the lines and dimensions of the body on the clay model.

**You put great emphasis on the dynamism of this model. But how sporty can a BMW 5 Series Sedan be?** A BMW must always be an expression of dynamics and motion! The 5 Series in particular appeals to customers who love driving, including long distances, and really appreciate the typical driving dynamics of a BMW. The proportions are clearly defined by the heritage of BMW sedans: short overhangs, long wheelbase, a long hood and the cockpit set well back.

**It seems you like working with lines. The door handles, for example, meld into the seam lines. The primary measures of BMW's design language are proportion and volume. It's only at second glance that the lines that delineate the spaces become visible.**

**Inside, you've opted, in general, for clearly defined spaces, with clean lines and no unnecessary frills. What's the reasoning behind that?** The interior, too, has to speak of dynamics and elegance. Our idea was to express this through smoothly flowing lines across the instrument panel and doors.

**How do you manage to create an interior with such a modern atmosphere?** First and foremost, by ensuring that the exterior and interior form a harmonious whole – and just like on the outside, the closer you look inside the BMW 5 Series, the more innovations you discover. For example, there's the momentum of the two lines on the instrument panel that's carried over onto the passenger side – something that only strikes you at second glance. Or the way the trim panel transitions from the instrument panel to the door, with a chrome-color highlight. It's the sum of these detailed refinements that explains the appeal of the BMW 5 Series interior.

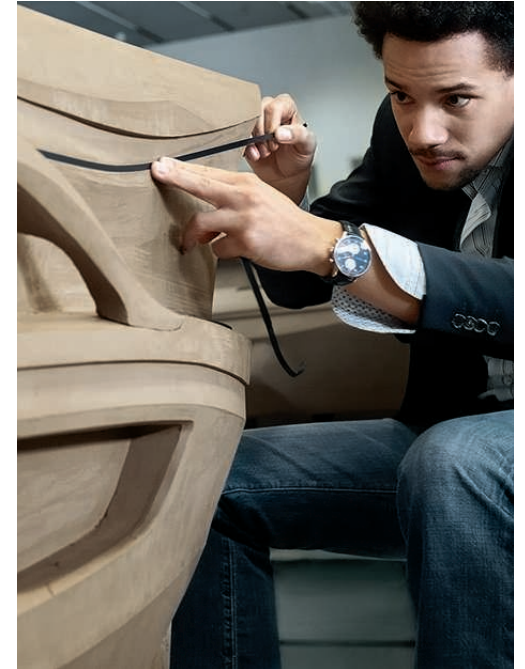

**The headlights are capped with a strip of frosted glass that looks like an eyebrow, while the taillights have a pronounced L-shape. Why did you go for these visuals?** Our "night design," as we call it, ensures that the BMW 5 Series can be clearly identified as a BMW even in the dark. That's why, at the front, we chose to have the "eyebrows" lend a slightly angular look to the round twin headlights. The L-shape of the taillights builds a bridge between tradition and progress. The Corona headlight-rings are also available with state-of-the-art LED technology.

**Were there any areas where you deliberately wanted to set this model apart from its predecessor?** This time around, we have designed a very upright kidney grille. In fact, we've gone back to giving it a slight forward angle. This shows, on the one hand, how firmly rooted we are in our own design history. On the other hand, it underpins the sporty character of this model. Overall, the latest BMW 5 Series Sedan looks a touch lower and wider than its predecessor – which means it looks even more dynamic.

**The kidney grille is particularly wide and striking in this model. Why is that?** Well, of course the kidney grille is not just a design element, it's also an important air inlet. But in the current BMW 5 Series the design of the kidney grille has one primary purpose. It says, "This is one sporty sedan!"

**Thank you very much for this exclusive interview! It was a pleasure talking to you.**



Emotional sketch of the exterior of the BMW 5 Series Sedan.





BMW translated the luxurious comfort of the 5 Series Sedan's interior to match the elegance of the exterior. Upon entering the cabin, it's clear that the vehicle's sweeping contours and clean lines have permeated the interior, as well. Choose from a wealth of sleek modern trims – like Anthracite Wood and Aluminum – as well as supple leather upholsteries, including BMW's optional plush Nappa Leather. Or take it to a rarefied level of luxury with the Extended Merino Leather upholstery and elegant trims of a BMW Individual Composition interior. Extensive Black Panel technology – both on the dash and in the center console – gives you easy-to-read information on everything from vital driving information, including speed and rpms, to climate control and Navigation system details; when not in use, the surface is clean, simple and dark. Speaking of controls, the driver-centric dashboard gives those behind the wheel quick and easy access to every knob, dial, wheel and button. Grasp the fourth-generation iDrive Controller and plot your course on a large, integrated 10.2-inch screen. And the Top- and Side-view Cameras provide visual assistance for parking and maneuvering in tight spaces, with images transmitted clearly to the iDrive screen. Intuitive, comfortable, and luxurious: the interior of the BMW 5 Series Sedan is a truly stunning complement to the vehicle's sharp lines and good looks.

Get the latest information on BMW standard and optional features, packages and technical specifications. Visit [bmwusa.com](http://bmwusa.com), select the BMW model of your choice, and click on "Features & Specs."

# PERFECTION.

## WHERE FUNCTIONAL INTEGRATION MEETS PURE EXHILARATION.



## DISCOVER A PLACE WHERE EVEN SITTING DOWN INSPIRES AWE.



In typical BMW fashion, every surface and corner of the BMW 5 Series Sedan cabin is finished in premium materials. Sit back in seats upholstered in plush optional Nappa Leather. Run your eyes over the dash, accented with rich wood trims. You'll soon discover just how inviting and inspiring elegant design truly can be. (Please note: Perforated Leather rear seats shown are not available in the U.S.)



The spacious rear cabin of the BMW 5 Series Sedan comfortably accommodates even tall passengers. An abundance of headroom and knee room combine to make every trip a rewarding experience. Once they are settled in, four-zone automatic air conditioning provides individually adjustable air settings for the two outer seats. Passengers of all ages will appreciate the rear-seat entertainment system that offers two 9.2-inch monitors, plus a separate DVD drive and easy-to-use controls. And a premium hi-fi system puts the power of 16 high-end speakers at your disposal, for creating an atmosphere of acoustic bliss on any trip. Who says the driver's seat is the only great place in the BMW 5 Series Sedan?

Get the latest information on BMW standard and optional features, packages and technical specifications. Visit [bmwusa.com](http://bmwusa.com), select the BMW model of your choice, and click on "Features & Specs."



# 5 MINUTES IN THE BMW 5 SERIES SEDAN.

**Falling in love only takes 3 seconds.  
Forming a deep, lasting friendship  
takes 4 minutes and 57 seconds longer.**

What do the first five minutes in the BMW 5 Series Sedan feel like? BMW researched the issue and documented the results. (The most important result was that the test subjects didn't really want to get out again.)

**2:47** It's so quiet, it's as if the world had been swaddled in a cotton blanket. Your senses become more acute. Everything in the cockpit, including the center console and gear selector lever, is focused toward you – the driver. Buttons can be reached with the tips of your fingers; just stretch out your hand.

**0:07** Operating the door handle is the first indication of things to come. The door opens with a satisfying sound that signals precise workmanship and first-class materials. You take your seat behind the steering wheel and look over the cockpit. Closing the door, you notice that it moves by itself the last couple of inches, then pulls itself shut, making barely a sound.

Get the latest information on BMW standard and optional features, packages and technical specifications. Visit [bmwusa.com](http://bmwusa.com), select the BMW model of your choice, and click on "Features & Specs."

**1:12** The clear cockpit layout seems pleasantly familiar, with high-quality materials that make for a superb look and feel. You run your fingertips over the different types of surfaces. The leather-wrapped steering wheel feels sporty and compact. How good it is to the touch!

**3:31** Press the Start button, and the vehicle's functions come to life. The BMW 5 Series Sedan talks to you in a wordless language. You twist, tilt and press the iDrive Controller, which functions with flawless precision. Everything is quick and easy to set up – like pairing your BMW-approved Bluetooth® mobile phone with the car.

**4:55** It's fun getting to know the interior. Exciting, too – like the first day at a job that you have been eagerly looking forward to. And then, the first press of the accelerator pedal. Still in neutral, you hear the power of the engine, feel its dynamic potential, can't wait to get going. And once you slide into gear, you know that you won't ever want to stop again.



# AUTHENTICITY



**PUT YOUR HANDS  
ON THE WHEEL  
AND YOUR MIND  
AT EASE.**

Driven to innovate, BMW imbued the 5 Series Sedan with a range of cutting-edge technologies that elevate the entire driving experience. But this is not technology for its own sake. Each groundbreaking feature is seamlessly designed and integrated for maximum operating efficiency and user-friendliness. Only in this way can we increase the thrill of The Ultimate Driving Machine® without losing its signature driving feel.





## BMW EFFICIENT DYNAMICS: VEHICLES THAT REQUIRE LITTLE AND GIVE A LOT.

BMW was one of the first automotive manufacturers to pursue efficient driving technologies – one part of our award-winning sustainability strategy. Our commitment to EfficientDynamics means we are continuously developing innovative systems that bring us closer to our long-term goal of emissions-free mobility. However, we remain equally committed to driving pleasure, which is being pursued in different ways. First, there is the continuing optimization of conventional diesel- and gasoline-powered models. Second, BMW hybrid vehicles are already on the road. Third, the first 100 percent electrically powered BMW – the BMW ActiveE – is being distributed in a field trial to customers. And fourth, the fleet of BMW Hydrogen 7 vehicles impressively demonstrated the potential for combining hydrogen drive with a combustion engine.

Since 1995 BMW has been able to reduce the CO<sub>2</sub> emissions of its entire fleet by approximately 30 percent and intends to achieve a further 25 percent reduction by 2020. BMW EfficientDynamics represents the most comprehensive package of innovative technologies currently in production, for reducing fuel consumption and emissions while simultaneously creating The Ultimate Driving Machine.<sup>®</sup>

### **Different paths to the same destination: unmistakable BMW driving pleasure.**

In early 2010 BMW launched its first production models with hybrid drive. Today the BMW ActiveHybrid 7, ActiveHybrid 5 and ActiveHybrid 3 offer an unparalleled combination of thrilling performance, increased fuel efficiency and reduced emissions. The BMW ActiveE, with its innovative 100 percent electric drive system, introduces an entirely new form of dynamic performance, paving the way for the future of emissions-free mobility. Finally, a completely new vehicle concept targeted at meeting the need for sustainable mobility in fast-growing metropolitan areas will soon become reality: the BMW i3.



## THE BMW 5 SERIES SEDAN'S EFFICIENT DYNAMICS INITIATIVE AT A GLANCE.

### **High-Precision Direct Injection.**

In this latest-generation direct fuel injection system, the piezo injectors are positioned very close to the spark plugs. They inject fuel at high pressure, with extreme precision, for very efficient combustion.

### **BMW TwinPower Turbo technology.**

This innovative turbocharging technology efficiently reclaims the energy contained in exhaust gases, using two turbochargers (550i and 550i xDrive) or using a twin-scroll charger (528i, 528i xDrive, 535i, 535i xDrive, and ActiveHybrid 5).

### **Valvetronic.**

BMW's Valvetronic valve control system improves engine response and refinement, while also helping to reduce fuel consumption. The system helps the engine "breathe" better by providing fully variable lift adjustment of the inlet valves.

### **8-speed STEPTRONIC automatic transmission.**

The close spacing of gear ratios in this 8-speed automatic transmission makes maximum use of the optimum rev range, reducing fuel consumption and allowing smoother shifts.

### **Auto Start-Stop function and Hybrid Start-Stop function.**

Even when idling, such as at a stop sign, an engine burns fuel. BMW's Auto Start-Stop function – or Hybrid Start-Stop function in the ActiveHybrid 5 – enhances fuel efficiency by switching off the engine. (The intelligent electronics system first checks the battery charge level and calculates if other electric systems, like the heated rear windshield, need more energy.) Once the brake pedal is released, the engine starts up again almost instantly. A Start-Stop signal in the display indicates the function is active.

### **Brake Energy Regeneration.**

In vehicles with Brake Energy Regeneration, the alternator generates electricity only when the driver takes his or her foot off the accelerator. Kinetic energy that was previously unharnessed is transformed into electrical energy, then fed into the battery. In this way, electricity is generated without consuming fuel.

### **Electric Power Steering.**

Unlike conventional, hydraulic steering systems, Electric Power Steering draws power only during actual steering movements. When the steering wheel position is constant, the electric motor is inactive.



# THREE ADVANCED ENGINES. ONE GREAT VEHICLE. THE BMW 5 SERIES SEDAN.

**Engines that power innovation.** Year after year, BMW engines have garnered accolades for their output, refinement and high-revving ability. Beneath the long hoods of the 5 Series Sedans are three of the world's most sophisticated engines. All are designed to deliver on BMW's EfficientDynamics philosophy: increased power with decreased fuel consumption and emissions. Whichever engine you select, you'll enjoy the thrill of BMW performance while helping to protect the environment every day.

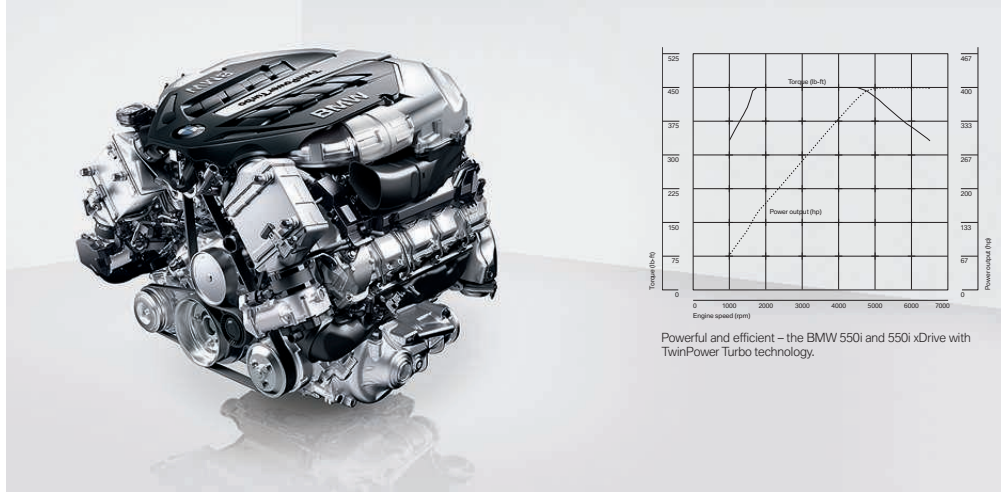

### BMW 550i and 550i xDrive.

BMW's 4.4-liter TwinPower Turbo V-8 is the essence of an iron fist in a velvet glove. Calling on two parallel turbochargers, its robust 400 hp accelerates the 550i xDrive smoothly from 0 to 60 mph in 4.7 seconds,<sup>1</sup> while the boost from 450 lb-ft of peak torque is sustained from 1750 all the way to 4500 rpm. Thanks to high-precision direct injection, this V-8 is also extremely fuel efficient.

### BMW 535i and 535i xDrive.

This unique engine combines a twin-scroll TwinPower Turbo, high-precision direct injection, and – in a first for turbocharged engines – BMW's Valvetronic variable intake technology that helps the engine “breathe” better. The result: turbo lag is virtually eliminated, while posting one of the most fuel-efficient ratings in its class. The 535i and 535i xDrive TwinPower Turbo develops maximum output of 300 hp at 5800 rpm, redlining at 7000 rpm. Peak torque of 300 lb-ft kicks in almost immediately at 1300 rpm. It continues to push you back in your seat all the way to 5000 rpm. In just 5.6 seconds the 535i xDrive is easily passing 60 mph<sup>1</sup> – and just as easily surpassing all expectations.

### BMW 528i and 528i xDrive.

Small is the next big idea in engines – namely, BMW's mighty inline four-cylinder TwinPower Turbo. Displacing just 2.0 liters, this 240-hp marvel generates 260 lb-ft of torque at just 1250 rpm, for potent thrust that kicks in right from the start and continues all the way up to 4800 rpm. Lightweight and smooth-running, it incorporates BMW's award-winning high-precision direct injection, Valvetronic and Double-VANOS technologies. Its dynamic performance is equaled by spectacular fuel efficiency, taking you further on every gallon of gas than did its six-cylinder predecessor.

**BMW's TwinPower Turbo four-cylinder engine.** Lightweight, fuel-efficient and lightning-fast, this powerful gasoline engine is designed to deliver five percent quicker acceleration and 20 percent greater fuel efficiency than its six-cylinder predecessor.

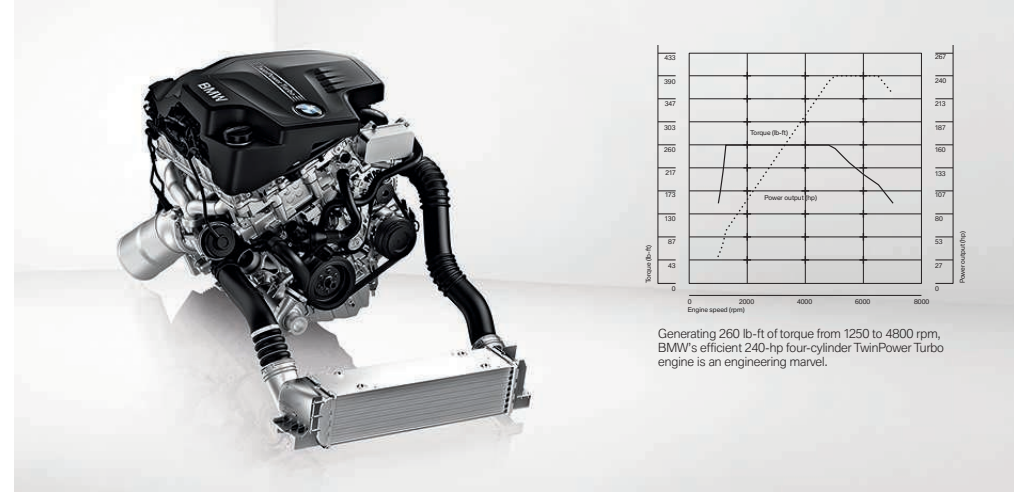

### 8-speed Sport Automatic transmission.

This Sport Automatic transmission adjusts to your style – from comfortable cruising to very dynamic driving. To change gears, use the selector lever or steering wheel-mounted gear shift paddles. In Sport mode, modified clutch settings allow very quick adjustments in engine speed for minimal shift times. The close spacing of the eight gears optimizes acceleration, while also maximizing efficiency and comfortable shifting.

### 8-speed STEPTRONIC automatic transmission.

Offering eight speeds with Adaptive Transmission Control (ATC), this transmission provides extremely fast synchronized shifting in either the Sport or Manual shift mode. By increasing the number of gears to eight, the transmission provides a more efficient shifting sequence and improved fuel economy.

### 6-speed manual transmission.

Prized by driving enthusiasts, this six-speed manual delivers a precise, athletic feel. Its responsiveness is due, in part, to the synchronization of shifts from neutral to each gear. The shortened shift lever and “throw” add to the sporty feel of the gearbox. The sixth gear drops revs at highway speeds for smooth cruising and better fuel economy.

Get the latest information on BMW standard and optional features, packages and technical specifications. Visit [bmwusa.com](http://bmwusa.com), select the BMW model of your choice, and click on “Features & Specs.”

<sup>1</sup> BMW AG test results. Please see page 64 for detailed technical data. BMW urges you to obey all posted speed laws and always wear safety belts.



# BMW ACTIVE HYBRID 5. LUXURY MEETS EXHILARATING HYBRID POWER.

Combining sportiness and elegance with BMW's intelligent drive concept, the BMW ActiveHybrid 5 introduces another facet to the 5 Series' confident balancing act of handling, luxury and practicality. Representing the next generation of BMW ActiveHybrids, this first full-hybrid BMW sedan proves it is possible to greatly enhance fuel efficiency without sacrificing thrilling performance. Its intelligent energy management system allows driving on electric power alone for over a distance of 2 to 2.5 miles at speeds up to 37 mph. Calling on combustion and electric power, the BMW ActiveHybrid 5 has a total output of 335 horsepower – and an extra 55-hp boost function for when even quicker acceleration is needed.

**Auxiliary air conditioning.** This enables the BMW ActiveHybrid 5 to be cooled down a few minutes before you enter the vehicle. This function is handled by a battery-powered electric air conditioning compressor and does not require a single drop of fuel. It can be conveniently activated from a distance, using the vehicle's remote key fob.

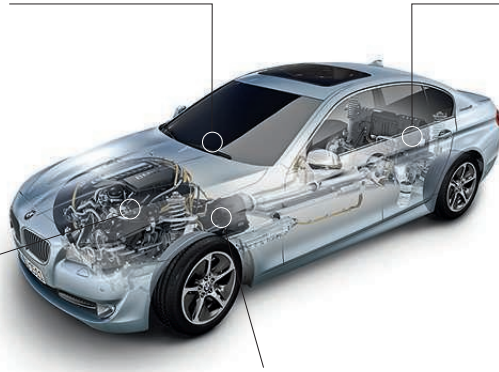

**High-performance lithium-ion battery.** This highly efficient, long-life battery supplies the BMW ActiveHybrid 5 with the power needed for electric-only driving for 2 to 2.5 miles at speeds of up to 37 mph. Using a more advanced form of Brake Energy Regeneration, this storage unit is recharged while driving, and whenever you lift your foot off the accelerator pedal.

**High-performance hybrid.** The BMW TwinPower Turbo inline six-cylinder engine, combined with the electric motor, delivers significantly reduced fuel consumption along with maximum dynamic performance.

**8-speed automatic transmission.** The tightly spaced 8-speed gear ratios allow the vehicle to make better use of the optimum rev range, enhancing fuel economy and shift comfort. In combination with the Hybrid Start-Stop function, this increases driving comfort while greatly lowering fuel consumption and emissions.



**Streamline (Style 364) 18 x 8.0 light alloy wheels** with 245/45 run-flat<sup>1</sup> all-season tires.<sup>2</sup> These exclusive, innovative aero rims help lower fuel consumption.



**8-speed automatic transmission gear selector** lever features an aluminum surround with special ActiveHybrid 5 signature.



**Aluminum door-sill finishers** with ActiveHybrid 5 lettering lead driver and passengers into an elegant interior marked by quality workmanship.



**ActiveHybrid 5 badging** behind the signature Hofmeister kink, as well as satin aluminum window frames and window recess finishers, identify the special vehicle.

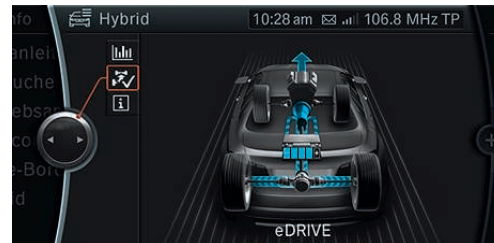

**All-electric driving.** The 40 kW (55 hp) output of the electric motor allows all-electric driving over longer distances. Using Driving Dynamics Control to activate the ECO PRO mode, the transmission uncouples the engine and shuts it off when you take your foot off the accelerator. This feature enables the BMW ActiveHybrid 5 to "sail" downhill almost silently at speeds of up to 100 mph. When the ECO PRO mode is deactivated, it is possible to sail at speeds of up to 50 mph.

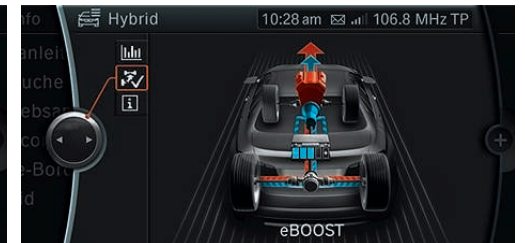

**Boost function.** When required, energy from the high-performance lithium-ion battery is used to enable a short-term 55-horsepower boost. A benefit of this technology is strong and immediate power delivery.

<sup>1</sup> Run-flat tires do not come equipped with a spare tire and wheel.

<sup>2</sup> Please note: Driving over rough or damaged road surfaces, as well as debris, curbs and other obstacles, can cause serious damage to wheels, tires and suspension parts. This is more likely to occur with low-profile tires, which provide less cushioning between the wheel and the road. Be careful to avoid road hazards and reduce your speed, especially if your vehicle is equipped with low-profile tires.

Wheel and tire specifications are subject to change. Get the latest information on BMW standard and optional features, packages and technical specifications. Visit [bmwusa.com](http://bmwusa.com), select the BMW model of your choice, and click on "Features & Specs."





The BMW 5 Series Sedan offers a host of innovative performance-enhancing technologies as well as active and passive safety features that help you get the most pleasure out of every drive.

## BMW xDRIVE INTELLIGENT ALL-WHEEL DRIVE: THE POWER TO MASTER ANYTHING THAT CROSSES YOUR PATH.

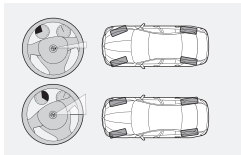

### Integral Active Steering.

With Integral Active Steering, at speeds up to 30 mph, a small turn of the steering wheel yields a greater turn of the front wheels for more direct response. It also steers the rear wheels up to 2.5 degrees in the opposite direction, giving the effect of a shortened wheelbase for enhanced maneuverability. When changing lanes at speeds over 50 mph, both front and rear wheels turn in the same direction, giving the feel of an extended wheelbase. While you experience greater responsiveness and directional stability, your passengers enjoy greater ride comfort from reduced body roll.

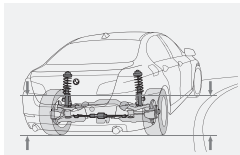

### Active Roll Stabilization.

When taking corners, the vehicle's body tends to roll, affecting handling. Active Roll Stabilization (ARS) twists special two-piece anti-roll bars to generate stronger resistance to body roll, keeping the vehicle more level and providing maximum stability and agility. Dynamic Damping Control (DDC), on the other hand, instantly adjusts shock absorbers from the softest to the firmest settings. The result is exceptional ride comfort and fluid handling at all times – during changes in vehicle speed, load or road and driving conditions.

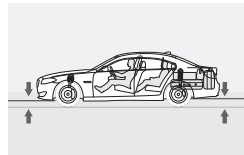

### Driving Dynamics Control.

This feature lets you adjust the 5 Series Sedan's driving characteristics by pressing a button. Choose from four settings: COMFORT, SPORT, SPORT+ or ECO PRO mode, to adjust engine-throttle response, transmission shift characteristics and power-steering assist. In addition, the traction control feature can be disengaged when driving on sand, gravel, or deep or packed snow.

### xDrive intelligent all-wheel-drive system.

The BMW 550i xDrive, 535i xDrive and 528i xDrive all deliver maximum traction, even in the most slippery road conditions. BMW's xDrive intelligent all-wheel-drive system monitors data such as engine speed, steering angle, wheel speeds and acceleration. On smooth, dry roads, more power is normally sent to the rear axle, giving vehicles with xDrive the feel of their rear-wheel-drive counterparts. But hit a wet uphill curve, for instance, and even before wheelspin can occur, the system immediately recognizes any need for a change in power distribution. Using a controlled clutch, it sends more torque to the front axle to enhance stability and achieve greater traction.

### 8-speed Sport Automatic transmission.

Enjoy quick, comfortable gear shifts, using the gear selector lever or steering wheel-mounted gear shift paddles. The close spacing of the eight gears optimizes acceleration while improving efficiency and shift comfort.

### Dynamic Stability Control (DSC).

DSC helps to stabilize the BMW 5 Series Sedan in just milliseconds when it senses an impending skid. Whenever the system senses over- or understeer, it modulates engine power and can apply brakes individually to each wheel to help keep the vehicle under control and going in the intended direction. For sportier driving or in deep snow, **Dynamic Traction Control (DTC)** allows increased wheelslip.

### Passive safety.

In the event of a collision, the Sedan's safety system determines which of six airbags to deploy for optimal protection. An extremely rigid steel "safety cage" surrounds the cabin, with deformable crush tubes front and rear. In a severe crash, impact energy is routed around the cabin and absorbed by the safety cage. In a severe side impact, a reinforcing bar hooks the door to the body, locking them together to make a more rigid passenger cell. When the pressure is released, the system is designed to snap back so that the doors can open.

Get the latest information on BMW standard and optional features, packages and technical specifications. Visit [bmwusa.com](http://bmwusa.com), select the BMW model of your choice, and click on "Features & Specs."



**BMW ConnectedDrive**  
In touch with your world.



Every day, our world is becoming increasingly networked. Through BMW ConnectedDrive, many BMW drivers are better connected than the rest, obtaining information on the road, communicating by phone or email, and always being updated on the latest events.

With BMW ConnectedDrive you stay in touch, no matter where you go. Its advanced communications and entertainment features create a network between driver, vehicle and environment, at any time and wherever you are. Take, for example, a Navigation system that helps you plan your route, avoid traffic jams – and stores your favorite music.

BMW Assist™ Safety Plan includes TeleService, which checks your vehicle's operating fluids and wear items. When they need replacing, it automatically notifies your authorized BMW center. A staff of BMW Assist response specialists and Concierges are there at the touch of a button, dedicated to assisting you every moment you're on the road.

At BMW, electronic systems will never replace the thrill of driving – but they do enhance the driving experience.

[bmwusa.com/connecteddrive](http://bmwusa.com/connecteddrive)

## CONNECTED DRIVE: BMW'S INTELLIGENT NETWORK OF DRIVER, CAR AND ENVIRONMENT.



"In dark, unlit areas, Automatic high beams give me all the light I need without dazzling oncoming drivers."



**Automatic high beams** let you enjoy the convenience of switching between high and low beams automatically. When the Automatic high beams system is activated, an image sensor at the back of the rear-view mirror monitors oncoming traffic and lighting conditions. Based on this data, the system decides whether or not the high beams should be switched on. When it detects vehicles ahead, or the sensor indicates that ambient light is sufficient, the high beams are automatically switched off.



**Speed Limit Info.** This system uses a camera installed close to the rear-view mirror to monitor posted speed-limit signs. Together with information supplied by the on-board Navigation system, it displays posted speed limits on the instrument cluster display and also in the Head-up Display.



**Advanced Real Time Traffic Information**, included in the Navigation system, makes you aware of traffic congestion in most large cities before you encounter it. This feature displays and describes current local traffic information on your Control Display; in case of delays greater than five minutes, it suggests alternate routes. The latest-generation Navigation system offers numerous upgrades, such as presenting menus in virtual, 3-D spaces; added functions in the split-screen Display; switching quickly from top view to perspective view; using superimposed layers for Advanced Real Time Traffic Information and weather updates; displaying points of interest, and more.



**BMW Night Vision<sup>1</sup> with Pedestrian Detection** helps you avoid dangerous situations by recognizing them sooner. With this feature, an infrared camera in the front bumper scans up to 900 feet ahead, detecting people and animals – and the direction of their movement, up to 300 feet away. The camera images are shown in the Control Display and, if so equipped, on the Head-up Display. Pedestrian Detection also gives a visual warning to indicate any people or animals that are moving close to the road.

<sup>1</sup> Night Vision performance is limited by rain, fog, humidity and other weather conditions.



# STAY TOTALLY IN TOUCH WHEREVER YOU GO – WITH BMW CONNECTED DRIVE.

Whether you're far from home or just in the next town, BMW Assist™ offers convenience and peace of mind. There are new ConnectedDrive features that extend BMW's leadership in wireless communications. Marvel at an extensive array of Mobile Office functions. Get a visual image of your callers. With BMW Assist, you enjoy all this – and more.



**BMW Apps** lets you access Social Networks, music PlugIn and Video Playback through your iPhone®, and see them on the Display screen.<sup>1</sup> Tune in to **Web radio** and search for stations from around the globe by name, location or genre. You can also store your favorite stations, find similar stations, display station information, and change the quality of the audio. Your favorite entries are stored on your iPhone, so you can take them with you from one vehicle to another.

Please note: • A broadband data link is required. The costs for this (e.g., data roaming) are regulated by the customer agreement with the mobile phone service provider.  
 • Not all features available while vehicle is in motion; see dealer for details.  
 • Web radio audio quality depends on the bit rate of the station, and data reception depends on your cell service. Data transfer comes over the iPhone.

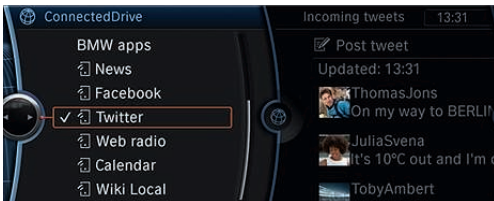

**BMW Connected App**, a suite of integrated web-connected features, can read aloud your Facebook® and Twitter™ feeds, and lets you send prewritten tweets with a single click. **Wiki Local**, a geographically based feature, finds and reads aloud Wikipedia® articles relevant to the place you select – while **Wiki Tourguide** takes you through a list of articles about nearby points of interest, prioritized by distance from your vehicle's current location. **The Last Mile Navigation and Vehicle Finder**, also included in the BMW Connected App suite, provides walking directions to your destination after you've parked – and directions back to your car later.

Please note: Local information may not be available in all areas.

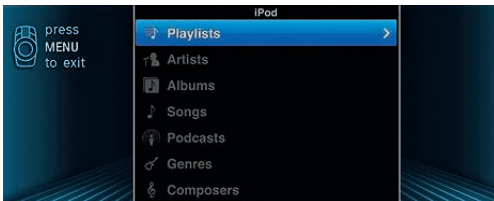

When you select **PlugIn** from the BMW Apps menu, the iPhone exports a typical iPod® look and control to your BMW through the video connection.<sup>1</sup> You can then search for your favorite music by playlist, artist, album, song, genre or composer, just as you would on your iPhone.

Please note: The BMW Connected App must be installed on your iPhone for the PlugIn to connect.

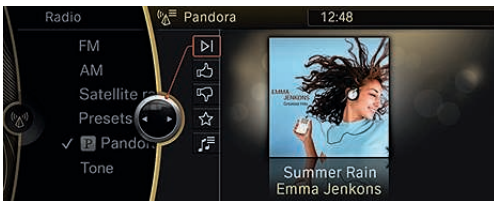

Part of BMW Apps, **Pandora Radio** is an innovative streaming audio service that delivers personalized music selections right to your BMW.<sup>1</sup> Create new stations and tailor your listening experience by rating songs with either a thumbs-up or thumbs-down. Even while listening, you can stay in touch: your BMW can still receive calls through Bluetooth® without missing a beat.



Enjoy the instant gratification of music on-demand in your BMW, thanks to **MOG**® – another part of BMW Apps. Browse, search and play any of 11 million songs in the MOG music library. Subscribing to MOG's **Primo** service allows you to take advantage of the seamless integration of MOG's mobile app.

<sup>1</sup> Requires BMW Apps option and an iPhone.

Get the latest information on BMW standard and optional features, packages and technical specifications. Visit [bmwusa.com](http://bmwusa.com), select the BMW model of your choice, and click on "Features & Specs."



Use the time you spend in your vehicle even more effectively with BMW's **Mobile Office** feature.<sup>2</sup> For example, text messages and emails can be transferred from your Bluetooth paired phone directly to the vehicle's iDrive Display and can be read back to you using Text-to-speech functionality and the vehicle's audio system. Thanks to Bluetooth audio streaming, you can enjoy wireless playback of your music files; your personal audio library can even be accessed via the iDrive Controller.

<sup>2</sup> Not all mobile phones are compatible with Mobile Office, and some compatible phones support a limited number of Mobile Office functions. For the complete list of compatible mobile phones and the details regarding which Mobile Office functions are supported by each phone, please visit [bmwusa.com/bluetooth](http://bmwusa.com/bluetooth).



**MyInfo** allows you to send business locations and street addresses to your BMW from Google Maps™ Destinations and phone numbers can be accessed and exported to your Navigation system for immediate route guidance.



**BMW Online** allows online access to up-to-date fuel prices and gas station locations; the latest weather forecasts, advisories and warnings; Dow Jones, S&P 500 and NASDAQ indices; and the powerful reach of the Google Maps database – all delivered on the Control Display inside your vehicle. Access news headlines and have them read aloud via Text-to-speech technology. "Send to Mail" pinpoints your current location and planned destination, and allows you to send the information to any smartphone or email account. Then it's just a quick hyperlink to Google Maps for your friends and family to see where you are and where you're going.



**Enhanced functions** for the iPod and USB adapter add to the ease and pleasure of using your iPod or iPhone. Want to know which CD that song comes from? The album cover is shown on your Display screen. Don't purchase additional cables – your iPod or iPhone's original USB cable connects to your BMW's USB port. Another rare feature: with BMW Assist and Bluetooth audio streaming, you can wirelessly play music through the BMW audio system from any Bluetooth compatible music player or mobile phone, from anywhere in your vehicle. In fact, the audio library appears on the Display screen, where you can use the iDrive Controller knob to make your selection.



**BMW Assist** gives you peace of mind knowing that a friendly response specialist is there to help you 24/7, at the touch of a button. The **Safety Plan** includes Automatic Collision Notification, Emergency Request (SOS), TeleService, Enhanced Roadside Assistance, Door Unlock, Stolen Vehicle Recovery, Customer Relations and MyInfo. The **Convenience Plan** adds personalized Directions, Traffic and Weather reports, BMW Online and Concierge services for restaurant and hotel recommendations, with the destination address and phone number sent to your BMW. Make up to four operator-assisted calls per year with Critical Calling if your mobile phone is not available or its battery is discharged.





#### Head-up Display.

When I am in the middle of rush-hour traffic, I don't want to take my eyes off the road, even for a second. Luckily, I don't have to. The Head-up Display projects Navigation instructions and other important information on the windshield, directly in my field of vision. In fact, it looks as if it is floating above the hood. How does Head-up Display work?

Inside the dashboard support structure, there is a monitor – similar to the display in a mobile phone. LEDs generate an image on this display. Then, like a slide projector, four mirrors project the image onto the windshield, enlarging it six times. Due to a clever optical arrangement, it appears to be about six feet away, so the driver's eyes don't have to keep refocusing. With no need to move the eyes back and forth between

the instrument cluster and the road, the driver stays less distracted and more relaxed.

#### Integral Active Steering.

My BMW 5 Series Sedan has Integral Active Steering. I love driving up in the mountains. Yet even in the middle of tackling the tightest twists and turns, I find I feel totally relaxed. Why is this?

While Active Steering varies just front-wheel steering efforts based on vehicle speed, Integral Active Steering controls the steering angle of both the front and rear wheels. At lower speeds, the rear wheels turn counter to the front wheels. This makes your vehicle feel as if it had a shorter wheelbase, for greater precision on, say, twisting mountain roads. At higher speeds, the rear wheels turn in the same direction as the front wheels. It responds as if it had a longer wheelbase, with enhanced control during quick highway lane changes. In other words, Integral Active Steering handles a lot of the work for you.

#### Active Ventilated Seats.

I drive long distances on my job. My BMW client advisor said that getting Active Ventilated Seats in my 5 Series Sedan would make a huge difference in how I felt. What do they do?

Active Ventilated Seats are constructed with two hollow cavities in the seat bottom. These are alternately filled and emptied with liquid. This slow, gentle process raises and lowers the

cushion's left and right halves by about half an inch. Although the movement is imperceptible, it acts to move your muscles, increasing blood flow. During long trips, this helps relieve fatigue. With the ventilation feature, multiple fans inside each front seat blow air upward through the perforated leather, helping to keep you feeling fresh and your clothes free of perspiration.

#### Active Cruise Control.

My friend has a 5 Series Sedan that is equipped with Active Cruise Control. How is this different from regular cruise control?

Let's say you're on a congested highway – slow-moving traffic that's more stop than go. It's a situation no driver relishes. But with Active Cruise Control, it's a whole different story. As soon as the vehicle ahead of you stops, your BMW also comes to a smooth, controlled halt. Once traffic starts moving again, so does your BMW, as if it had eyes of its own. And it does: a radar sensor monitors the area in front of the car. Its visual range extends from just in front of the bumper to 500 feet ahead – more than one and one-half football fields – because Active Cruise Control is not just for slow traffic. It also works at higher speeds, up to 110 mph.<sup>1</sup> The system also includes the Forward Collision Warning feature, which uses two warning levels to alert you to a potential collision.

<sup>1</sup> BMW urges you to obey all posted speed laws and always wear safety belts.



#### BMW Parking Assistant.

Every evening it's always the same: searching for a parking space. I waste so much time and energy trying to squeeze into spots that are too short. My client advisor told me that the 5 Series Sedan has a Parking Assistant feature that can not only find parking spaces, it can even help me park. How does it do that?

When you press the "Parking Assistant" button, drive under 22 mph and keep within five feet of the row of parked cars – on the left or the right – ultrasonic sensors integrated into the side indicators measure the size of all parking spaces. If you pass a space that's at least four feet longer than your vehicle, a green light will come on, and it will appear on your Control Display. Put your vehicle in reverse gear, take your hands off the steering wheel, and press the accelerator or brake pedal. The 5 Series Sedan takes care of everything else. Park Distance Control or the Rear-view Camera will always let you know how close you are to other parked vehicles.

#### iPhone® and Bluetooth® connectivity.

After taking delivery of my BMW 5 Series Sedan, I got in, pressed the Start button, and heard my favorite song playing through the speakers. Was this luck – or BMW wizardry?

Once they are connected, or "paired," the 5 Series Sedan communicates perfectly with your iPhone or any other BMW-approved, Bluetooth capable mobile phone. Your address book and the music library are also automatically available. It's all thanks to Bluetooth wireless technology and the hands-free equipment in your BMW. You can access phone numbers stored in your mobile phone via the iDrive Controller or the buttons on the steering wheel. To start a hands-free call, simply press a button.



## SIX TECHNICAL QUESTIONS.



## A personalized classic.



Offering an extensive array of exterior paints and interior upholstery and trims, BMW lets you create a statement of your individuality. For example, this 535i Sedan is coated in classic Titanium Silver Metallic paint and upholstered in handsome

Black Dakota Leather upholstery. But it has received the personalizing touch of Light Wood interior trim. The counterpoint of dark leather and Light Wood is beautiful, elegant – and unexpected.

Wheel and tire specifications are subject to change. Get the latest information on BMW standard and optional features, packages and technical specifications. Visit [bmwusa.com](http://bmwusa.com), select the BMW model of your choice, and click on "Features & Specs."

## Polished dynamics.



Like a form-fitting tuxedo on an athlete, Black Sapphire Metallic paint elegantly delineates the muscles of the BMW 550i Sedan. Inside the masterfully crafted cabin ringed by Dark Wood trim, Multi-contour seats are upholstered in Oyster/Black Dakota Leather. The three-spoke sport steering wheel further enhances the dynamic look and feel of the interior, while the 18-inch Star Spoke (Style 330) light alloy wheels with run-flat all-season tires<sup>1</sup> enhance the crisp handling.

<sup>1</sup>Run-flat tires do not come equipped with a spare tire and wheel. Driving over rough or damaged road surfaces, as well as debris, curbs and other obstacles, can cause serious damage to wheels, tires and suspension parts. This is more likely to occur with low-profile tires, which provide less cushioning between the wheel and the road. Be careful to avoid road hazards and reduce your speed, especially if your vehicle is equipped with low-profile tires.





## The M Sport Package. Maximized thrills.



**M Sport Package:** A 5 Series Sedan equipped with the M Sport Package looks and feels more purposeful. Outside, shadowline trim and Double Spoke M light alloy wheels with low-profile run-flat<sup>1</sup> tires – either performance<sup>2</sup> or, on xDrive models, all-season – underscore its sporty nature. An Aerodynamic

kit hints at the increased top-speed limiter. Get in and grip the three-spoke leather-wrapped M sport steering wheel. The cabin's athletic atmosphere is underscored by Aluminum Hexagon trim – an M Sport Package exclusive – as well as the Anthracite headliner and M signature touches throughout the cabin.



**19-inch Double Spoke (Style 351M)** light alloy wheels with either **run-flat<sup>1</sup> all-season** or **performance tires<sup>2</sup>**, depending on model.



**Double Spoke (Style 350M)** 18 x 8.0 front, 18 x 9.0 rear light alloy wheels with 245/45 front and 275/40 rear **run-flat<sup>1</sup> performance tires<sup>2, 3</sup>**



**Rear diffuser** increases downforce on the rear axle at high speeds. The Dark Chrome finish of the tailpipes further adds to the car's visual appeal.



**Three-spoke, leather-wrapped multi-function M sport steering wheel** includes a thick, textured rim and thumb indents that are designed for performance driving.



**Door sills** with the instantly identifiable M logo announce that this is a special breed of sedan as soon as a door is opened.

<sup>1</sup> Run-flat tires do not come equipped with a spare tire and wheel.

<sup>2</sup> Performance tires are not recommended for driving in ice and snow conditions.

<sup>3</sup> Also available as 18 x 8.0 M light alloy wheels with 245/45 run-flat all-season tires.



Driving over rough or damaged road surfaces, as well as debris, curbs and other obstacles, can cause serious damage to wheels, tires and suspension parts. This is more likely to occur with low-profile tires, which provide less cushioning between the wheel and the road. Be careful to avoid road hazards and reduce your speed, especially if your vehicle is equipped with low-profile tires.

Wheel and tire specifications are subject to change. Get the latest information on BMW standard and optional features, packages and technical specifications. Visit [bmwusa.com](http://bmwusa.com), select the BMW model of your choice, and click on "Features & Specs."



## BMW Individual. The most exclusive way to drive a BMW.

For those who dream of a vehicle that reflects their own unique personality, there is BMW Individual.

The BMW Individual collection of exclusive paints, leathers and trims takes the BMW 5 Series Sedan to all-new heights of luxury. Only the finest, perfectly matched materials are selected to create each expertly handcrafted interior.

BMW Individual exterior colors are noted for their brilliant effects. An innovative five-coat paint process generates a two-tone iridescence that creates ever-changing nuances in sun and shadow. The special pigmentation below the surface of these brilliant hues lend BMW Individual paint finishes their extraordinary intensity.

One unforgettable example is Champagne Quartz Metallic. The characteristic iridescence of the paint finish varies from a golden brown to a blue-violet, depending on the angle of light. Other dramatic BMW Individual paint finishes available on the 5 Series Sedan include Azurite Black Metallic, Citrin Black Metallic, Moonstone Metallic and Amazonite Silver Metallic.

Reflecting the elegance outside, the interior is swathed in Extended Merino Leather, shown here in BMW Individual Platinum. The natural surface texture has a soft, velvety feel and a "breathability" that adds to your comfort. Set off by rich Walnut Honey Wood trim, it creates an oasis of supreme luxury.



Experience BMW Individual interactive. With the BMW Individual iPad® App.

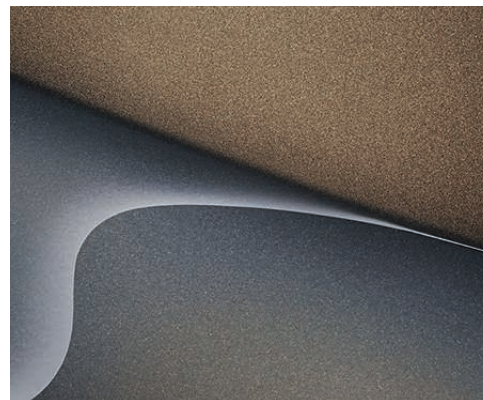

BMW Individual Champagne Quartz Metallic paint.



V Spoke (Style 349) 19 x 8.5 front, 19 x 9.0 rear light alloy wheels with 245/40 front, 275/35 rear run-flat<sup>1</sup> performance tires.<sup>2,3</sup>



Graphite Extended Merino Leather with Piano Finish Black interior trim.



Extended Merino Leather trim in Platinum.

The BMW Individual 5 Series in Champagne Quartz Metallic paint.



<sup>1</sup> Run-flat tires do not come equipped with a spare tire and wheel. Driving over rough or damaged road surfaces, as well as debris, curbs and other obstacles, can cause serious damage to wheels, tires and suspension parts. This is more likely to occur with low-profile tires, which provide less cushioning between the wheel and the road. Be careful to avoid road hazards and reduce your speed, especially if your vehicle is equipped with low-profile tires.

<sup>2</sup> Performance tires are not recommended for driving in snow and ice.

<sup>3</sup> Also available with 19 x 8.5 light alloy wheels and 245/40 run-flat all-season tires.

Wheel and tire specifications are subject to change. Get the latest information on BMW standard and optional features, packages and technical specifications. Visit [bmwusa.com](http://bmwusa.com), select the BMW model of your choice, and click on "Features & Specs."



The interior is upholstered in BMW Individual Platinum Extended Merino Leather, accented by Walnut Honey Wood trim.



## Exterior colors.



**668** Jet Black (Non-metallic)

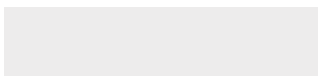

**300** Alpine White (Non-metallic)



**475** Black Sapphire Metallic



**354** Titanium Silver Metallic



**A52** Space Gray Metallic



**A72** Cashmere Silver Metallic



**A84** Milano Beige Metallic



**A76** Deep Sea Blue Metallic



**A81** Tasman Green Metallic



**A17** Mojave Metallic



**B90** Dark Graphite Metallic



**A89** Imperial Blue Metallic



**416** Carbon Black Metallic



**B40** Liquid Blue Metallic



BMW Individual



**X02** Citrin Black Metallic



**S34** Azurite Black Metallic



**X04** Moonstone Metallic



**X07** Amazonite Silver Metallic



**X08** Champagne Quartz Metallic

## Upholstery materials and colors.



**K8DF** Venetian Beige Leatherette



**K8SW** Black Leatherette



**LCSW** Black Dakota Leather



**LCDE** Everest Gray Dakota Leather



**LCDF** Venetian Beige Dakota Leather

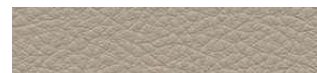

**LCCX** Oyster/Black Dakota Leather

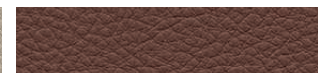

**LCEZ** Cinnamon Brown/Black Dakota Leather



**NASW** Black Nappa Leather



**NACX** Oyster/Black Nappa Leather



BMW Individual



**ZAP8** Graphite Extended Merino Leather



**ZAP7** Silk Gray Extended Merino Leather



**ZAC8** Platinum Extended Merino Leather



**ZAP6** Champagne Extended Merino Leather



**ZAWT** Cohiba Brown Extended Merino Leather

Leather upholstery: Leather on all seating surfaces; other components may be Leather or Leatherette.

The pages in this section of the brochure show available colors and materials for the BMW 5 Series Sedan. Use these samples to compare paint, upholstery, trim colors and combinations. Please note that these samples are representations; they are not exact reproductions. To see the actual colors, visit your local BMW center. They will be happy to show you original samples and assist you with special requests.

Please refer to the Recommended color combinations chart on page 53. For details on the availability of standard and optional exterior paints and upholstery materials and colors, please visit [bmwusa.com/byo](http://bmwusa.com/byo).



## Interior trims.



4CE Fineline Anthracite Wood



4B5 Light Wood



4BN Dark Wood



4B9 Aluminum



4MR Aluminum Hexagon



BMW Individual



XE5 Dark Red Sycamore Wood



XE6 Walnut Honey Wood



XE7 Piano Finish Black

For details on the availability of standard and optional interior trims, please visit [bmwusa.com/byo](http://bmwusa.com/byo).

## Recommended color combinations.

| Upholstery materials  | Leatherette    |       | Dakota Leather |              |                |                      |              | Nappa Leather |              | BMW Individual Extended Merino Leather |                 |          |                 |                    |
|---|----------------|-------|----------------|--------------|----------------|----------------------|--------------|---------------|--------------|--|-----------------|----------|-----------------|--------------------|
|   | Venetian Beige | Black | Black          | Everest Gray | Venetian Beige | Cinnamon Brown/Black | Oyster/Black | Black         | Oyster/Black | Graphite/Black                         | Silk Gray/Black | Platinum | Champagne/Black | Cohiba Brown/Black |
| <b>Upholstery colors</b>  |                |       |                |              |                |                      |              |               |              |  |                 |          |                 |                    |
| <b>Exterior colors</b>  |                |       |                |              |                |                      |              |               |              |  |                 |          |                 |                    |
| 668 Jet Black (Non-metallic)  | ●              | ●     | ●              | ●            | ●              | ●                    | ●            | ●             | ●            | ●                                      | ●               | ●        | ●               | ●                  |
| 300 Alpine White (Non-metallic)   | ●              | ●     | ●              | ●            | ●              | ●                    | ●            | ●             | ●            | ●                                      | ●               | ●        | ●               | ●                  |
| 475 Black Sapphire Metallic   | ●              | ●     | ●              | ●            | ●              | ●                    | ●            | ●             | ●            | ●                                      | ●               | ●        | ●               | ●                  |
| 354 Titanium Silver Metallic  | ●              | ●     | ●              | ●            | ●              | ●                    | ●            | ●             | ●            | ●                                      | ●               | ●        | ●               | ●                  |
| A52 Space Gray Metallic   | ●              | ●     | ●              | ●            | ●              | ●                    | ●            | ●             | ●            | ●                                      | ●               | ●        | ●               | ●                  |
| A72 Cashmere Silver Metallic  | ●              | ●     | ●              | ●            | ●              | ●                    | ●            | ●             | ●            | ●                                      | ●               | ●        | ●               | ●                  |
| A84 Milano Beige Metallic   | ●              | ●     | ●              | ●            | ●              | ●                    | ●            | ●             | ●            | ●                                      | ●               | ●        | ●               | ●                  |
| A76 Deep Sea Blue Metallic  | ●              | ●     | ●              | ●            | ●              | ●                    | ●            | ●             | ●            | ●                                      | ●               | ●        | ●               | ●                  |
| A81 Tasman Green Metallic   | ●              | ●     | ●              | ●            | ●              | ●                    | ●            | ●             | ●            | ●                                      | ●               | ●        | ●               | ●                  |
| A17 Mojave Metallic   | ●              | ●     | ●              | ●            | ●              | ●                    | ●            | ●             | ●            | ●                                      | ●               | ●        | ●               | ●                  |
| B90 Dark Graphite Metallic  | ●              | ●     | ●              | ●            | ●              | ●                    | ●            | ●             | ●            | ●                                      | ●               | ●        | ●               | ●                  |
| A89 Imperial Blue Metallic  | ●              | ●     | ●              | ●            | ●              | ●                    | ●            | ●             | ●            | ●                                      | ●               | ●        | ●               | ●                  |
| 416 Carbon Black Metallic   | ●              | ●     | ●              | ●            | ●              | ●                    | ●            | ●             | ●            | ●                                      | ●               | ●        | ●               | ●                  |
| B40 Liquid Blue Metallic  | ●              | ●     | ●              | ●            | ●              | ●                    | ●            | ●             | ●            | ●                                      | ●               | ●        | ●               | ●                  |
| <b>BMW Individual exterior colors</b>   |                |       |                |              |                |                      |              |               |              |  |                 |          |                 |                    |
| X02 Citrin Black Metallic   | ●              | ●     | ●              | ●            | ●              | ●                    | ●            | ●             | ●            | ●                                      | ●               | ●        | ●               | ●                  |
| S34 Azurite Black Metallic  | ●              | ●     | ●              | ●            | ●              | ●                    | ●            | ●             | ●            | ●                                      | ●               | ●        | ●               | ●                  |
| X04 Moonstone Metallic  | ●              | ●     | ●              | ●            | ●              | ●                    | ●            | ●             | ●            | ●                                      | ●               | ●        | ●               | ●                  |
| X07 Amazonite Silver Metallic   | ●              | ●     | ●              | ●            | ●              | ●                    | ●            | ●             | ●            | ●                                      | ●               | ●        | ●               | ●                  |
| X08 Champagne Quartz Metallic   | ●              | ●     | ●              | ●            | ●              | ●                    | ●            | ●             | ●            | ●                                      | ●               | ●        | ●               | ●                  |
| <b>Interior trims</b>   |                |       |                |              |                |                      |              |               |              |  |                 |          |                 |                    |
| 4CE Fineline Anthracite Wood  | ●              | ●     | ●              | ●            | ●              | ●                    | ●            | ●             | ●            | ●                                      | ●               | ●        | ●               | ●                  |
| 4B5 Light Wood  | ●              | ●     | ●              | ●            | ●              | ●                    | ●            | ●             | ●            | ●                                      | ●               | ●        | ●               | ●                  |
| 4BN Dark Wood   | ●              | ●     | ●              | ●            | ●              | ●                    | ●            | ●             | ●            | ●                                      | ●               | ●        | ●               | ●                  |
| 4B9 Aluminum  | ●              | ●     | ●              | ●            | ●              | ●                    | ●            | ●             | ●            | ●                                      | ●               | ●        | ●               | ●                  |
| 4MR Aluminum Hexagon  | ●              | ●     | ●              | ●            | ●              | ●                    | ●            | ●             | ●            | ●                                      | ●               | ●        | ●               | ●                  |
| <b>BMW Individual interior trims</b>  |                |       |                |              |                |                      |              |               |              |  |                 |          |                 |                    |
| XE5 Dark Red Sycamore Wood  | ●              | ●     | ●              | ●            | ●              | ●                    | ●            | ●             | ●            | ●                                      | ●               | ●        | ●               | ●                  |
| XE6 Walnut Honey Wood   | ●              | ●     | ●              | ●            | ●              | ●                    | ●            | ●             | ●            | ●                                      | ●               | ●        | ●               | ●                  |
| XE7 Piano Finish Black  | ●              | ●     | ●              | ●            | ●              | ●                    | ●            | ●             | ●            | ●                                      | ●               | ●        | ●               | ●                  |
| Leather upholstery: Leather on all seating surfaces; other components may be Leather or Leatherette.  |                |       |                |              |                |                      |              |               |              |  |                 |          |                 |                    |
| For details on the availability of standard and optional exterior paints and upholstery materials and colors, please visit <a href="http://bmwusa.com/byo">bmwusa.com/byo</a> . |                |       |                |              |                |                      |              |               |              |  |                 |          |                 |                    |

## Equipment features and options.



**Xenon Adaptive Headlights** optimize road illumination when entering a turn or corner, helping to enhance visibility when driving at night. Sensors continuously monitor the angle of the steering wheel to determine the direction in which your vehicle is heading. The outer headlights swivel accordingly, up to 15 degrees left or right.

**Xenon low- and high-beam headlights** illuminate the road ahead and to the side with brilliant clarity. An auto-leveling feature adjusts for varying passenger and cargo loads. LED **Corona headlight-rings** that circle both headlights and high beams also act separately as Daytime Running Lights and parking lights.



**Taillight cluster** with taillight, brakelight and turn-signal indicators incorporate LED technology for greater visibility.

**Adaptive Brakelights** warn following vehicles by increasing in brightness when the intensity of your braking action is increased.



**Two-way power glass moonroof** with remote, expanded one-touch operation slides back or tilts up to let in as much fresh air and sky as you like, while the wind deflector helps keep the interior breeze-free. A sliding interior sunshade shields passengers from sun heat and glare.



**Shadowline trim** replaces the front and rear side-window chrome frames and door-sill trim strips with the sporty look of a black high-gloss finish.



**Heated, power-adjustable exterior mirrors** feature a body-color upper section, black bottom. **Automatic-dimming exterior mirrors** cut headlight glare from any following vehicles, and include power-folding function.



**Door handles** combine sleek design and practical use. A horizontal chrome accent strip incorporates courtesy lights that illuminate the immediate area when the door is unlocked.



**Two circular-shape chrome-surround exhaust tips** are cleanly integrated into the left side of the 528i and 528i xDrive rear fascia. The 535i, 535i xDrive and ActiveHybrid 5 are identified by one exhaust tip on the left side and one on the right.



**Dual rectangular-shape chrome-surround exhaust tips** integrated into each side of the rear fascia of the BMW 550i and 550i xDrive identify these V-8 models.



**Radial Spoke (Style 237)** 18 x 8.0 light alloy wheels with 245/45 **run-flat**<sup>1</sup> all-season tires.<sup>2</sup>



**V Spoke (Style 349)** 19 x 8.5 front, 19 x 9.0 rear light alloy wheels with 245/40 front and 275/35 rear **run-flat**<sup>1</sup> performance tires.<sup>2, 3</sup>

**V Spoke (Style 349)** 19 x 8.5 light alloy wheels with 245/40 **run-flat**<sup>1</sup> all-season tires.<sup>2</sup>



**Double Spoke (Style 351M)** 19 x 8.5 front, 19 x 9.0 rear light alloy wheels with 245/40 front and 275/35 rear **run-flat**<sup>1</sup> performance tires.<sup>2, 3</sup>

**Double Spoke (Style 351M)** 19 x 8.5 light alloy wheels with 245/40 **run-flat**<sup>1</sup> all-season tires.<sup>2</sup>



**Star Spoke (Style 330)** 18 x 8.0 light alloy wheels with 245/45 **run-flat**<sup>1</sup> all-season tires.<sup>2</sup>



**Double Spoke (Style 350M)** 18 x 8.0 front, 18 x 9.0 rear light alloy wheels with 245/45 rear and 275/40 rear **run-flat**<sup>1</sup> performance tires.<sup>2, 3</sup>

**Double Spoke (Style 350M)** 18 x 8.0 light alloy wheels with 245/45 **run-flat**<sup>1</sup> all-season tires.<sup>2</sup>



**Star Spoke (Style 327)** 17 x 8.0 light alloy wheels with 225/55 **run-flat**<sup>1</sup> all-season tires.



**Streamline (Style 364)** 18 x 8.0 light alloy wheels with 245/45 **run-flat**<sup>1</sup> all-season tires.

<sup>1</sup> Run-flat tires do not come equipped with a spare tire and wheel.

<sup>2</sup> Due to low-profile tires, please note: Driving over rough or damaged road surfaces, as well as debris, curbs and other obstacles, can cause serious damage to wheels, tires and suspension parts. This is more likely to occur with low-profile tires, which provide less cushioning between the wheel and the road. Be careful to avoid road hazards and reduce your speed, especially if your vehicle is equipped with low-profile tires.

<sup>3</sup> Performance tires are not recommended for driving in snow and ice.

Wheel and tire specifications are subject to change. For details on the availability of standard and optional wheels and tires, features, packages and technical specifications, please visit [bmwusa.com](http://bmwusa.com), select the BMW model of your choice, and click on "Features & Specs."



## Equipment features and options.



**Three-spoke leather-wrapped multi-function sport steering wheel**, featuring power tilt/telescoping adjustments, lets you keep both hands on the steering wheel while adjusting the audio as well as a BMW-approved, Bluetooth enabled mobile phone, if so equipped. The left-hand buttons operate all cruise control functions, while those on the right control audio functions, such as the radio and, if so equipped, telephone and Voice command.

**Heated steering wheel** is a feature that, like heated seats, becomes a "must-have" once it's experienced. The heating switch is conveniently located on the multi-function steering wheel.



**Three-spoke leather-wrapped multi-function steering wheel** provides buttons on the left for operating the cruise control functions, and buttons on the right for adjusting all audio-related functions, including a BMW-approved, Bluetooth® enabled mobile phone, if so equipped.



**Auto Start-Stop or Hybrid Start-Stop function**, when activated, temporarily turns off the engine when it is not needed, such as when stopped at a red light, then turns it on again. This reduces fuel consumption and lowers emissions.



**Cruise control<sup>1</sup>** lets you store and maintain a chosen speed above approximately 18.5 mph by accessing the feature's buttons on the left side of the multi-function steering wheel.



**Active Cruise Control (ACC) with Stop & Go<sup>1</sup>** lets you preset both desired speed and following distance. When ACC recognizes slower vehicles ahead, it reduces your speed to maintain the preset distance. Stop & Go can bring you to a complete stop if traffic calls for it. When you press the accelerator, ACC resumes your speed according to your presets.



**Black Panel Display** shows the instrument cluster as a matte black surface when the ignition is switched off, with only the chrome rings of the circular instruments visible in 3-D. When the ignition is switched on, the graphics display lights up, showing the trip computer and Check Control information; below the four analog dials is a high-res, wide-format Info Display.

<sup>1</sup> Cruise control is not a substitute for the driver's own responsibility in adjusting speed and otherwise controlling the vehicle. After evaluating the road, traffic and visibility conditions, the driver must decide whether and how the system is used. The Stop & Go feature of ACC includes Forward Collision Warning which sounds an alert if you are approaching a vehicle ahead too quickly.

<sup>2</sup> Requires clearly definable lane markings that are not obscured by rain, snow, etc. The feature is not a substitute for the driver's own responsibility in maintaining safe control of the vehicle.



**6-speed manual transmission** delivers a precise, athletic feel. Its responsiveness is due, in part, to the synchronization of shifts from neutral to each gear. The shortened shift lever and "throw" add to the sporty feel of the gearbox. The sixth gear drops revs at highway speeds for smooth cruising and better fuel economy.



**8-speed STEPTRONIC automatic transmission** with Adaptive Transmission Control (ATC) provides extremely fast synchronized shifting in either the Sport or Manual shift mode. By increasing the number of gears to eight, the transmission provides a more efficient shifting sequence and improved fuel economy.



**BMW EfficientDynamics** in action: each time you take your foot off the gas pedal, Brake Energy Regeneration transforms the vehicle's kinetic energy into electricity, which is used to charge the battery. As a result, the battery draws less power from the engine, effectively reducing fuel consumption. Whenever this occurs, a blue indicator in the tachometer lights up.



**Head-up Display** projects important travel information, such as current speed and Check Control data, on the windshield directly in your line of vision in full color. Directional arrows from the Navigation system (if so equipped) can also be displayed.



**Lane Departure Warning feature<sup>2</sup>** senses when your vehicle is crossing over roadway lane markings or is changing lanes without signaling, and warns you by sending a mild vibration through the steering wheel. The system can be turned on and off via a button by the steering wheel.



**Active Blind Spot Detection** is activated when you use the turn-signal indicator before changing lanes. This feature warns if a vehicle is in your blind spot, or if a vehicle is approaching at high speed in the passing lane.



**Parking Assistant** makes parking a breeze by searching for suitable parking spots and then steering your vehicle into them. Simply press the "Park Assistant" button, then drive along potential parking spaces on the left or right side of the road, staying below 22 mph and no more than five feet away. Using ultrasonic sensors integrated into the side indicators, the system searches for and measures parking spaces. When a space at least four feet longer than your vehicle is spotted, it is shown on your Control Display. Shift into reverse and Park Assistant takes control of steering your vehicle into the selected space; you operate the accelerator and brake pedals. The acoustic and visual warnings of Park Distance Control (PDC) provide assistance.



**Rear-view Camera** shows on the Control Display the area behind your vehicle. Working with Park Distance Control, interactive guidelines indicate if a parking space can accommodate the vehicle, and display parking trajectories and turn angles. The Rear-view Camera is activated by engaging reverse gear.

**Park Distance Control (PDC)** uses eight sensors – four in the front, four in the rear – to help you judge how close you are to other vehicles and unseen objects when parking. The warning beeps come faster as the bumper approaches the object, turning into a constant tone when the distance is less than 12 inches.



**Side- and Top-view Cameras** display video images on the Control Display of traffic approaching the front of the vehicle from the sides, such as when exiting a garage or parking space, by using cameras positioned in the front bumpers. The Top-view Camera provides video images of the road alongside doors, taken by cameras positioned in the exterior mirrors.

Get the latest information on BMW standard and optional features, packages and technical specifications. Visit [bmwusa.com](http://bmwusa.com), select the BMW model of your choice, and click on "Features & Specs."



## Equipment features and options.



**iDrive Controller**, conveniently located on the center console, is the central command element for the iDrive system. It can be rotated, pushed and tilted to operate various functions via the Control Display. Four frequently selected menus – media, radio, Navigation system and telephone – can be called up using direct menu-control buttons.



**Control Display** shows the functions of the iDrive Controller, vehicle settings and radio, as well as the Navigation system. The glare-free, high-resolution color monitor is located next to the instrument cluster, at an ideal viewing height and distance.



**BMW Assist™** Safety Plan is included for four years, providing Automatic Collision Notification, Emergency Request, Roadside Assistance, Door Unlock, Stolen Vehicle Recovery, TeleService and more. The optional Convenience Plan offers Directions, Traffic and Weather, Critical Calling, and Concierge services, as well as BMW Online, which allows online access to current fuel prices, weather forecasts, Bloomberg's stock indices and the powerful reach of the Google Maps™ database. (Visit [bmwassist.com](http://bmwassist.com) for details.)



**Navigation system** features a high-resolution, glare-free monitor, and uses GPS satellites in conjunction with data stored on an internal hard drive. Includes 3-D daytime and nighttime maps, zoom, travel planner and multiple perspective views. A split-screen feature allows simultaneous viewing of the Navigation map while viewing and selecting other items within the various iDrive menus and submenus. The system also provides Advanced Real Time Traffic Information on potential traffic problems and solutions.



**Hard disc drive**, included as part of the Navigation system, provides 12 GB of music and data storage. Upload or download music to or from the hard drive via the in-dash player or a USB port. It also has the capability to "rip" CDs directly from the in-dash player.



**Integrated Owner's Manual** provides quick and immediate access to all vehicle-specific information. The Owner's Manual can be accessed via the iDrive and shown on the Control Display. The system's user-friendly features includes multimedia elements such as animations and dynamic illustrations.



**BMW Night Vision with Pedestrian Detection** can scan up to 900 feet ahead using an infrared camera in the front bumper.<sup>1</sup> It can detect people and animals, as well as the direction of their movement, up to approximately 300 feet away, and displays their presence on the iDrive screen and Head-up Display (if so equipped). The system gives a visual warning as soon as pedestrians or animals move toward the road, alerting you to potential dangers significantly earlier, so you can react more quickly.



<sup>1</sup> Under optimal road conditions. Night Vision performance is also limited by rain, fog, humidity and other weather conditions.



**2-zone automatic climate control** allows driver and front passenger to select individual temperatures and choice of fan speeds, as well as choose automatic or manual airflow and recirculation. The automatic recirculation control activates whenever certain air pollutants are detected. The system also offers a mist-up sensor, solar sensor and residual heat use.



**4-zone automatic air conditioning** builds on the 2-zone system with air vents in the B-pillar and at the rear of the center console, to ensure virtually draftless ventilation for rear-seat passengers. Additionally, the temperature in both the left and right rear cabin can be tailored via two control dials with displays.



**Rear-seat entertainment** includes two tilt-adjustable, independently operated 9.2-inch color screens integrated into the back of the front seats. The system includes a remote Controller and headphone jacks.



**BMW Apps**, a feature of the BMW ConnectedDrive interface, allows an iPhone® iOS 4.x to play apps specially modified for BMW.

**Smartphone Integration** for iPhone and similar devices allows access to stored music, can improve signal reception, and recharges the phone battery. See your BMW center for compatible phone models.



**BMW anti-theft AM/FM stereo CD/MP3 audio system** offers Radio Data System (RDS), Auto-Store, and 3-channel FM diversity antenna system. Includes a 10-speaker, multi-channel hi-fidelity sound system incorporating an analog amplifier with 180-watt output power. The system includes 3 tweeters, 5 mid-range speakers and 2 central bass speakers.



**Bang & Olufsen® High End Surround Sound System** offers superior acoustics, thanks to innovative Dirac Dimensions™ signal processing and 16 loudspeakers with a total output of 1,200 watts, including a retractable center speaker. This houses the midrange speaker and the Acoustic Lens Technology that ensures consistent sound quality at all seats. You have the choice between two sound settings: "Studio" for particularly crisp sound and "Expanded" for a more open sound space. The loudspeakers' lighting completes this audiovisual experience.



Get the latest information on BMW standard and optional features, packages and technical specifications. Visit [bmwusa.com](http://bmwusa.com), select the BMW model of your choice, and click on "Features & Specs."



## Equipment features and options.



**18-way power Multi-contour front seats** conform to your body to provide optimum support and exceptional comfort over long distances. In addition to horizontal, vertical and angled adjustments, Multi-contour seats include an articulated upper backrest, Comfort headrest (two-way power, two-way manual "relax headrest"), and four-way power-adjustable lumbar support. Both driver's and front-passenger's seats include memory function.

**Active front seats** imperceptibly raise and lower the left and right halves of the seating surface. This movement keeps the spine in motion, exercising various support muscles to help reduce fatigue on longer trips.



**Ambiance lighting** adds the drama of a warm reddish light that runs from front to rear beneath the inner door ledge. Interior lighting also includes soft white rear reading and footwell lights, illumination of the front center armrest storage compartment, indirectly lit door pockets, exit lights, and proximity illumination in the outside door handles.



**Rear side sunshades** keep the sun's heat and glare away from the rear cabin while maintaining your privacy. When not in use, these manually adjustable sunshades conveniently disappear into the side doors.



**Power rear sunshade** can be extended with the touch of a button to protect the cabin from the sun's rays in warm weather or retracted to allow the sun to help warm the interior in colder weather.



**10-way power-adjustable driver's and front passenger's seats** with memory system for driver's seat, steering wheel and outside mirrors. **Lumbar support** in the front seats adds four-way power-adjustable support for the lower back. Lumbar positions can be customized with up/down and in/out adjustments.

**Heated rear seats** are a welcome feature in cooler weather for left and right rear-seat occupants. With the touch of a button, passengers can individually select their preferred level of warmth.

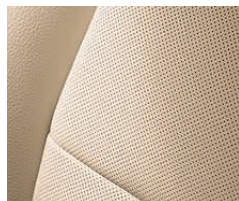

**Active Ventilated seats** gently blow warm or cool air through the micro-perforations in the leather to keep driver and front passenger comfortably dry in hot weather, and warm in colder weather.



**Front armrest** with integrated storage compartment opens up to allow access to the iPod® and USB adapter, and Smartphone Integration adapter.



**Rear seat backrests** can be folded individually in a 60/40 split to optimize the number of passengers and amount of cargo.

**Ski bag** accommodates up to four pairs of skis or other long objects for practical transport inside the vehicle. The bag protects transported items while simultaneously protecting the vehicle interior from damage.



**Storage space** under the trunk floor adds covered cargo room. The illuminated trunk can be opened via remote and interior release.

**Power trunk lid** opens and closes automatically via remote control. **Central locking** for doors and fuel cap includes Coded Driveaway Protection.



**Comfort access system** offers convenient keyless access to your vehicle when you carry the remote key in a pocket or purse. The hands-free trunk-lid opening function automatically unlocks and opens the trunk when you stand behind the vehicle and move your foot under the center of the rear bumper. You can also unlock the doors merely by touching the door handle.

**Automatic soft-close** feature uses small electric motors to gently pull all four doors shut the last few inches.

Get the latest information on BMW standard and optional features, packages and technical specifications. Visit [bmwusa.com](http://bmwusa.com), select the BMW model of your choice, and click on "Features & Specs."

## Equipped with the best ideas. Original BMW Accessories.

Driving a BMW is always a special experience, which can be enhanced even further with Original BMW Accessories. Benefit from innovative solutions combining unique ideas, stunning design and supreme functionality. Discover the wide range of Original BMW Accessories available to you, enhancing such vehicle aspects as the exterior, interior, technology, transporters, protection and details to customize your vehicle. For additional information on Original BMW Accessories, please visit your authorized BMW center or [shopbmwusa.com](http://shopbmwusa.com).

Leave a sporty impression with a **Carbon Fiber Rear Deck Lid Spoiler** and **20-inch Cross Spoke (Style 312) cast alloy wheels** coated in BMW Ferric Gray.



BMW's selection of **trunk mats** help keep your trunk protected, clean and looking new.



**Snap-in Adapter with USB interface** plays stored music through your vehicle speakers, charges the phone and accesses the car antenna for better reception.



**Infrared stereo headphones**, specially designed for use with the optional BMW rear-seat entertainment system.

## CRAFT YOUR OWN BMW – AT [BMWUSA.COM/BYO](http://BMWUSA.COM/BYO).



At BMW, we want you to create your own Ultimate Driving Machine®. That's why BMW offers one of the widest model ranges of any luxury automotive manufacturer. And each BMW model offers its own universe of personalizing possibilities.

It's easy to get the latest information on your favorite BMW model. Simply visit [bmwusa.com](http://bmwusa.com) and click on the BMW model of your choice. Select **"Features & Specs"** to see all the standard features and available options and packages, as well as technical specifications.

Then create the exact BMW model that fulfills your needs by clicking on **"Build Your Own"** – or just visit [bmwusa.com/byo](http://bmwusa.com/byo). Here you'll be able to select from among the many interior and exterior colors and trims, personalizing options and value-added packages. Build a BMW model that reflects your style, then view it in 360° detail. At the press of a button, see payment and financing options, get a same-day quote, download a product brochure and even schedule a test drive. BMW makes it easier than ever to make your ultimate driving dreams come true, at [bmwusa.com](http://bmwusa.com).



| Weight                          |     | 528i      | 528i xDrive | 535i      | 535i xDrive | 550i      | 550i xDrive | ActiveHybrid 5 |
|---------------------------------|-----|-----------|-------------|-----------|-------------|-----------|-------------|----------------|
| Unladen weight                  |     |           |             |           |             |           |             |                |
| Manual transmission             | lbs | —         | —           | 4068      | —           | 4365      | —           | —              |
| Automatic transmission          | lbs | 3814      | 4001        | 4090      | 4233        | 4365      | 4519        | 4398           |
| Weight distribution, front/rear |     |           |             |           |             |           |             |                |
| Manual transmission             | %   | —         | —           | 50.9/49.1 | —           | 52.5/47.5 | —           | —              |
| Automatic transmission          | %   | 49.4/50.6 | 50.1/49.9   | 50.9/49.1 | 52.9/47.1   | 52.5/47.5 | 53.9/46.1   | 49.1/50.9      |

### Engine

| Type/cylinders/valves per cylinder |       | TwinPower Turbo Inline 4/4 | TwinPower Turbo Inline 4/4 | TwinPower Turbo Inline 6/4 | TwinPower Turbo Inline 6/4 | TwinPower Turbo V-8/4 | TwinPower Turbo V-8/4 | TwinPower Turbo Inline 6/4 |
|------------------------------------|-------|----------------------------|----------------------------|----------------------------|----------------------------|-----------------------|-----------------------|----------------------------|
| Displacement                       | cc    | 1997                       | 1997                       | 2979                       | 2979                       | 4395                  | 4395                  | 2979                       |
| Bore/stroke                        | inch  | 3.30/3.50                  | 3.30/3.50                  | 3.30/3.50                  | 3.30/3.50                  | 3.50/3.50             | 3.50/3.50             | 3.30/3.50                  |
| Nominal output/rpm                 | hp    | 240/5000-6500              | 240/5000-6500              | 300/5800                   | 300/5800                   | 400/5500-6400         | 400/5500-6400         | 335/5800                   |
| Max. torque/rpm                    | lb-ft | 260/1250-4800              | 260/1250-4800              | 300/1300-5000              | 300/1300-5000              | 450/1750-4500         | 450/1750-4500         | 300/1300-5000              |
| Compression ratio                  | :1    | 10.0                       | 10.0                       | 10.2                       | 10.2                       | 10.0                  | 10.0                  | 10.2                       |

### Transmission

|                       |              |                |                |                     |                |                     |                |                |
|-----------------------|--------------|----------------|----------------|---------------------|----------------|---------------------|----------------|----------------|
| Manual gear ratios    | I/II/III:1   | —              | —              | 4.11/2.32/1.54      | —              | 4.06/2.40/1.58      | —              | —              |
|                       | IV/V/VI/R:1  | —              | —              | 1.18/1.00/0.85/3.73 | —              | 1.19/1.00/0.87/3.68 | —              | —              |
| Final drive ratio     |              | —              | —              | 3.23                | —              | 3.08                | —              | —              |
| Automatic gear ratios | I/II/III:1   | 4.71/3.14/2.11 | 4.71/3.14/2.11 | 4.71/3.14/2.11      | 4.71/3.14/2.11 | 4.71/3.14/2.11      | 4.71/3.14/2.11 | 4.71/3.14/2.11 |
|                       | IV/V/VI:1    | 1.67/1.29/1.00 | 1.67/1.29/1.00 | 1.67/1.29/1.00      | 1.67/1.29/1.00 | 1.67/1.29/1.00      | 1.67/1.29/1.00 | 1.67/1.29/1.00 |
|                       | VII/VIII/R:1 | 0.84/0.67/3.30 | 0.84/0.67/3.30 | 0.84/0.67/3.30      | 0.84/0.67/3.30 | 0.84/0.67/3.32      | 0.84/0.67/3.32 | 0.84/0.67/3.32 |
| Final drive ratio     | :1           | 3.23           | 3.23           | 3.08                | 3.08           | 2.81                | 3.08           | 2.99           |

### Performance

|                                    |                |           |           |           |           |           |           |           |
|------------------------------------|----------------|-----------|-----------|-----------|-----------|-----------|-----------|-----------|
| Top speed <sup>1</sup>             | mph            | 130 [155] | 130 [150] | 130 [155] | 130 [155] | 130 [155] | 130 [155] | 130 [150] |
| Acceleration 0-60 mph <sup>2</sup> |                |           |           |           |           |           |           |           |
| Manual transmission                | sec            | —         | —         | 5.7       | —         | 5.0       | —         | —         |
| Automatic transmission             | sec            | 6.2       | 6.3       | 5.7       | 5.6       | 5.0       | 4.7       | 5.7       |
| Drag coefficient                   | C <sub>d</sub> | 0.29      | 0.29      | 0.29      | 0.30      | 0.30      | 0.30      | 0.28      |

### Fuel consumption<sup>3</sup>

|                             |     |       |       |       |       |       |       |       |
|-----------------------------|-----|-------|-------|-------|-------|-------|-------|-------|
| Manual transmission         |     |       |       |       |       |       |       |       |
| City/highway                | mpg | —     | —     | 20/30 | —     | 15/22 | —     | —     |
| Automatic transmission      |     |       |       |       |       |       |       |       |
| City/highway                | mpg | 23/34 | 22/32 | 20/30 | 21/30 | 15/23 | 15/20 | 23/30 |
| Fuel tank capacity, approx. | gal | 18.5  | 18.5  | 18.5  | 18.5  | 18.5  | 18.5  | 17.7  |

Figures in [ ] apply to vehicles with Sport Package or M Sport Package.

<sup>1</sup> Top speed limited electronically.

<sup>2</sup> BMW AG test results; preliminary for 5 Series xDrive models and ActiveHybrid 5. Actual acceleration results may vary, depending on specification of vehicle; road and environmental conditions; testing procedures and driving style. These results should be used for comparison only and verification should not be attempted on public roads. BMW urges you to obey all posted speed laws and always wear safety belts.

<sup>3</sup> EPA-estimated figures are for comparison purposes only. Your actual mileage will vary, depending on speed, driving habits, trip length and driving conditions; actual mileage may be lower.

| Wheels           | 528i        | 528i xDrive | 535i        | 535i xDrive | 550i        | 550i xDrive | ActiveHybrid 5 |
|------------------|-------------|-------------|-------------|-------------|-------------|-------------|----------------|
| Tire dimensions  | 225/55      | 225/55      | 245/45      | 245/45      | 245/45      | 245/45      | 245/45         |
| Wheel dimensions | 17 x 8.0    | 17 x 8.0    | 18 x 8.0    | 18 x 8.0    | 18 x 8.0    | 18 x 8.0    | 18 x 8.0       |
| Material         | light alloy | light alloy | light alloy | light alloy | light alloy | light alloy | light alloy    |

### Ventilated disc brakes

|                |      |      |      |      |      |      |      |      |
|----------------|------|------|------|------|------|------|------|------|
| Front/diameter | inch | 13.0 | 13.0 | 13.7 | 13.7 | 13.7 | 13.7 | 13.7 |
| Rear/diameter  | inch | 13.0 | 13.0 | 13.0 | 13.0 | 13.6 | 13.6 | 13.6 |

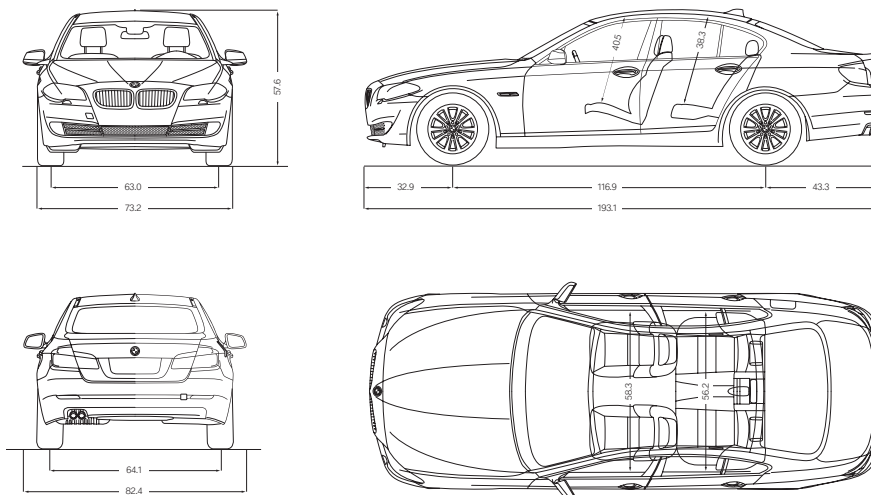

All dimensions in the technical drawings are shown in inches.

U.S. Importer: BMW of North America, LLC, Woodcliff Lake, NJ 07677. All illustrations and specifications contained in this brochure are based on the latest product information available at the time of printing. BMW reserves the right to make changes at any time, without notice, in colors, materials, equipment, specifications and models. BMW may, subject to legal requirements, determine the Model Year designation of its vehicles. The Model Year designation on any particular model may be longer or shorter than 12 months. Some vehicles pictured may contain non-U.S. equipment. Some models may be shown with optional equipment. While BMW NA makes all reasonable efforts to provide accurate information in this brochure, there is no guarantee or warranty of accuracy. Furthermore, we do not assume any liability for the accuracy or completeness of information presented. This brochure shall not be used or relied upon as a substitute for information that is available from your BMW center. Further information can be obtained from your authorized BMW center or bmwusa.com.

©2012 BMW of North America, LLC. Not to be reproduced wholly or in part without written permission of BMW NA. The BMW name, logo, model names and SAV are registered trademarks.

The Bluetooth word mark and logos are owned by the Bluetooth SIG, Inc. and any use of such marks by BMW is under license. iPhone, iPad and iPod are registered trademarks of Apple Inc. Other trademarks and trade names are the property of their respective owners.

We believe that a premium ownership experience should feature performance and luxury, as well as safety and convenience. We believe you should be able to drive a BMW to its potential, while enjoying peace of mind and reduced cost of ownership. That's the idea behind **BMW Ultimate Service**<sup>®</sup>: a suite of comprehensive programs and services that are included in every new BMW vehicle.

BMW Ultimate Service starts with the **New Vehicle/SAV Limited Warranty**,<sup>1</sup> providing you with coverage for the first four years or 50,000 miles, whichever comes first. Additionally, you have 12-year, unlimited-mileage warranty protection against corrosion and rust perforation.<sup>1</sup> The **BMW Maintenance Program**<sup>2</sup> and **BMW Assist**,<sup>3</sup> as well as **BMW Roadside Assistance** come standard.

## GOING BEYOND ENGINEERING: THE HIGH-PERFORMANCE BMW OWNERSHIP EXPERIENCE.

**BMW Maintenance Program** is one of the most comprehensive maintenance programs in its class. We cover all factory-recommended maintenance during the New Vehicle/SAV Limited Warranty coverage period. This includes scheduled oil services and inspections. Also covered is the replacement of items that are subject to normal wear and tear, such as brake pads, wiper blade inserts and engine drive belts.<sup>2</sup> And, thanks to BMW's advanced engineering, most owners enjoy a well-balanced maintenance schedule, with flexible routine service intervals that can save you time. When your vehicle requires attention, your authorized BMW center ensures that it receives only genuine BMW parts – your assurance of exacting quality standards.

For more details on BMW Ultimate Service and the BMW Maintenance Program, visit your authorized BMW center or log on to [bmwusa.com/ultimateservice](http://bmwusa.com/ultimateservice).

**BMW Assist Safety Plan**<sup>3</sup> is a four-year program that lets you enjoy peace of mind knowing that a friendly response specialist is there to help you, 24/7, at just the push of a button. The Safety Plan includes Automatic Collision Notification, Emergency Request, Enhanced Roadside Assistance, Door Unlock, Stolen Vehicle Recovery and Customer Relations. Included in the BMW Assist Safety Plan, MyInfo allows you to send business locations and street addresses with their associated phone numbers from the Google Maps™ website directly to your BMW. The destination can be sent to your Navigation system for turn-by-turn directions. With the BMW Navigation system and your mobile phone linked to your BMW via Bluetooth® technology, BMW's Mobile Office feature<sup>4</sup> transfers text messages and emails to your iDrive Display screen and reads them aloud to you. A Calendar and To-do List can also appear on your Display screen while en route. Running late? Click on the phone number in the Calendar to call your appointment. For a list of tested mobile phones, visit [bmwusa.com/bluetooth](http://bmwusa.com/bluetooth).

For the ultimate in coverage, add the optional **BMW Assist Convenience Plan**.<sup>5</sup> You'll enjoy unlimited access to personalized Directions, Traffic and Weather reports, as well as our Concierge feature, which can send a destination address and phone number, such as a restaurant or hotel, right to your BMW. You can make up to four operator-assisted calls per year with Critical Calling if your cell phone is not available, or if its battery is discharged. BMW Online allows access to up-to-date fuel prices and the latest weather forecasts, as well as Bloomberg's stock indices and the powerful reach of the Google Maps database – delivered to the iDrive Display right inside your vehicle.

BMW's unique **TeleService**, included in the BMW Assist Safety Plan, continually monitors specific parts that are subject to wear and tear – including the engine oil, micro-filter, spark plugs, brake linings and various fluids – as well as services that require attention at regular intervals, such as vehicle service inspections. This data is automatically transmitted to your authorized BMW center, which

will then call you to schedule a service appointment. You don't have to keep track of when your vehicle requires routine maintenance. An added benefit: any needed maintenance service parts will already be on hand, so your BMW is serviced and returned to you as quickly as possible. And because they use only Original BMW Parts, you can rely on expert fit and long-lasting BMW quality. For more details on TeleService, visit [bmwassist.com](http://bmwassist.com).

**BMW Roadside Assistance** is provided free of charge for the first four years – with no mileage limit. Call **1-800-332-4BMW (4269)** for friendly on-the-road help, 24/7, anywhere in the United States, Canada and Puerto Rico. This includes everything from flat-tire changes, emergency gasoline and lock-out service, to towing, alternative transportation and even trip-interruption benefits. This service also provides valuable trip-routing advice.



**BMW Virtual Center.** If you get the sudden urge to shop for a BMW but your authorized BMW center is closed, there's good news – the BMW Virtual Center is open 24 hours a day! Log on to [bmwusa.com/byo](http://bmwusa.com/byo), and choose the model that interests you. Configure the BMW of your dreams, and see what the monthly payments would be. You can even send the specifications for your authorized BMW center, apply for financing, or request a test drive – all online!

**BMW Financial Services.** Arranging to buy or lease a BMW is easier than you may think. Your authorized BMW center offers leasing and financing to suit your personal needs through BMW Financial Services.<sup>6</sup> Start the process at our website, where you can build your "dream vehicle," get an estimate on a monthly lease or financing payment, submit a credit application to BMW Financial Services – and get approval – all online!<sup>6</sup> To find out how BMW Financial Services can help put you behind the wheel of your favorite BMW model, log on to [bmwusa.com/fs](http://bmwusa.com/fs) or call, toll-free, **1-800-578-5000**.

**BMW Magazine.** A fascinating view of the latest events and products in the world of BMW, including travel reviews, personality profiles, and the latest BMW technologies. Sent to new owners and lessees several times a year, you can also read articles from **BMW Magazine** on the BMW website at [bmwusa.com](http://bmwusa.com) under the "Media Gallery & Library" heading, found in the "Experience" section.

**BMW Welt:** The **BMW Welt** ("BMW World") delivery and brand-experience center in Munich is bold proof of BMW's passion for design. When you take advantage of the BMW European Delivery Program,<sup>7</sup> this is where you will meet your new BMW – in a personalized process that is highly dramatic and totally unforgettable. (You might also realize substantial savings that just may pay for your trip.) While you're there, marvel at the historic BMWs in the Museum; learn about our engineers' newest innovations in the Technology and Design Atelier; and take a tour of the plant to experience firsthand the state-of-the-art methods used to create a BMW. Then comes the unique experience of driving your new BMW on the roads it was designed for. To learn more, visit [bmwusa.com/europeandelivery](http://bmwusa.com/europeandelivery).

<sup>1</sup> See your authorized BMW center for details on these limited warranties.

<sup>2</sup> The BMW Maintenance Program covers factory-recommended maintenance services as determined by the Service Interval Indicator for all new eligible MY 2004 and later BMW vehicles. Specific additional items that need replacement due to normal wear and tear are also covered. The maintenance coverage period is for the first 4 years or 50,000 miles, whichever comes first. Exclusions from coverage include: gasoline, gasoline additives, windshield washer fluid and additives, battery, tires, wheels, wheel alignment and tire balancing. All work must be performed by an authorized BMW center. See the Service and Warranty Information booklet for specific terms, conditions and limitations. Further information can also be obtained from your authorized BMW center.

<sup>3</sup> BMW Assist with 4 years of Safety Plan services is standard. In order to receive BMW Assist services, a subscriber agreement must be completed and transferred to the BMW Assist Response Center. GPS and underlying wireless services must be available and functioning; vehicle ignition must be turned on (except for Door Unlock and Stolen Vehicle Recovery), battery charged and connected and vehicle's electrical system operational; services may be limited to certain geographic areas. Call toll-free **1-888-333-6118**, go to [bmwassist.com](http://bmwassist.com), or visit your authorized BMW center for additional program details. Services are subject to the terms and conditions of your subscriber agreement.

<sup>4</sup> Not all mobile phones are compatible with Mobile Office, and some compatible phones support a limited number of Mobile Office functions. For the complete list of compatible mobile phones and the details regarding which Mobile Office functions are supported by each phone, please visit [bmwusa.com/bluetooth](http://bmwusa.com/bluetooth).

<sup>5</sup> Requires BMW Assist Safety Plan subscription. Services are subject to the terms and conditions of your subscriber agreement. Please go to [bmwassist.com](http://bmwassist.com) for additional details on the optional Convenience Plan.

<sup>6</sup> Subject to credit approval and other terms and conditions.

<sup>7</sup> Not all models available for BMW European Delivery Program. Please go to [bmwusa.com](http://bmwusa.com) or visit your authorized BMW center for details.



## THE MOST EXCITING PLACE IN AMERICA TO DRIVE A BMW.

### The BMW Performance Center in Spartanburg, SC.

Just beyond the foothills of the Carolinas' Blue Ridge Mountains lies the \$12 million BMW Performance Center. This sprawling, modern complex houses the world-famous BMW Performance Driving School, as well as the Zentrum Museum, BMW Boutique, BMW Delivery Center, and a Corporate Conference Center. Nearby is BMW's only manufacturing facility in the U.S., where models, such as the SAV,<sup>®</sup> are built for export worldwide. It's a unique place where BMW enthusiasts can spend days – or, in the surrounding area, an entire vacation.

### BMW Performance Driving School.

Whether you've been driving for decades or just got your learner's permit, we can help take your driving skills to the next level. Behind the wheel of our new BMWs and under the expert guidance of professional driving instructors, you'll hone your driving skills on a versatile driving course – 1.7 miles of asphalt that can be configured in a multitude of ways. In One- and Two-Day Schools you can tackle the skid pad, slalom course and water walls. The BMW Performance Driving School is about control and pushing a BMW to its limits – and yours.

### BMW Performance Center Delivery.

You'll always remember the fun of taking delivery of your new BMW – with BMW Performance Center Delivery. After enjoying dinner and an overnight stay at a first-class hotel, we'll take you and your companion to the Performance Center where a Product Specialist will give you an in-depth introduction to your new BMW. Then at the Performance Driving School, you'll get tips from a professional driving instructor as you explore the dynamic capabilities of a similar model. It's exciting, it's enlightening – and it's all compliments of BMW with your new vehicle.

To learn more about the BMW Performance Center, call 888-345-4269 or visit [bmwusa.com/performancecenter](http://bmwusa.com/performancecenter).



More about BMW



bmwusa.com  
1-800-334-4BMW

The Ultimate  
Driving Machine®



#### **BMW and the environment.**

BMW is a strong proponent of the environment and social responsibility. We launched BMW EfficientDynamics back in 2000 – the philosophy of providing greater power with increased efficiency and fewer emissions. This has resulted in significant benefits today – for our customers, the climate and the environment.

That year, ecological sustainability was also declared one of BMW's core strategic principles; it is now firmly anchored in our entire production chain. It starts with the development of fuel-saving and alternative vehicle concepts, continues with environmentally friendly production processes, and ends with innovative recycling methods. This effort has been recognized worldwide; in 1999, BMW AG – the parent company of BMW of North America and BMW Manufacturing Co. in Spartanburg, SC – was the first automotive company to be represented on the Dow Jones Sustainability Group Index. It has remained on the Index ever since; moreover, since 2005, BMW has been voted the world's most sustainable automobile manufacturer. At BMW, we strive for and achieve high performance in all we do.



BMW recommends **EDGE**