

BMW 6 Series
Coupe
Convertible

640i
640i xDrive
650i
650i xDrive



The Ultimate
Driving Machine®



THE BMW 6 SERIES COUPE AND CONVERTIBLE.

DRIVING ELEVATED TO ART.

BMW EfficientDynamics
Less emissions. More driving pleasure.



TO YOU, DRIVING IS A NON-SPECTATOR SPORT.

In the BMW 6 Series, driving is a singularly exciting experience to be savored. Some 6 Series drivers seek their thrills in sleek Coupe form; others find nirvana under the open sky in the Convertible. But the choices do not end there. The BMW 6 Series further personalizes your driving pleasure by offering inline six-cylinder or V-8 TwinPower Turbo engines and a silky-smooth 8-speed Sport Automatic transmission; rear-wheel drive or xDrive all-wheel drive; and an endless array of personalizing colors, features and options. Best of all, no matter how you build your BMW 6 Series Coupe or Convertible, every mile will deliver its own unique pleasures.

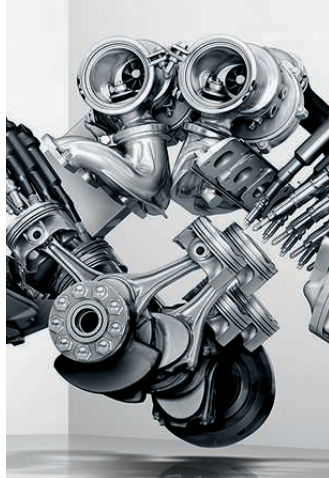

The BMW 6 Series Coupe and Convertible

DESIGNED FOR EXCELLENCE.

- 06 Exterior**
Sporty elegance.
- 08 Performance**
The power of freedom.
- 10 Electronic assistance features**
Technologies offering fresh perspectives.
- 12 Convertible softtop**
Zero to sky in 19 seconds.
- 14 Driver assistance features**
Innovations that drive performance.
- 16 Technological efficiency**
Meeting the challenge of sustainability.
- 20 Adaptive LED Headlights**
A tradition of elegance.
- 22 Interior design**
The intersection of elegance and comfort.

bmwusa.com/6series

Technology

INNOVATION IN MOTION.

- 26 BMW ConnectedDrive®**
So connected, you're free.
- 30 BMW EfficientDynamics**
Technology that increases excitement and reduces fuel consumption and emissions.
- 32 BMW engine technology**
A heritage of innovation.
- 34 Chassis systems**
Confidence-inspiring handling.
- 36 Active and passive safety features**
Innovative systems for enhanced and confident driving enjoyment.
- 38 Full-color BMW Head-up Display**
The art of drawing the eye to the essential.

bmwusa.com/technology

Equipment

AS INDIVIDUAL AS YOUR DREAMS.

- 40 Combination examples**
- 44 M Sport Package**
- 46 M Sport Edition**
- 48 BMW Individual**
- 50 Exterior colors, upholstery colors and materials**
- 52 Softtop colors and interior trims**
- 54 Equipment features and options**
- 63 Original BMW Accessories**
Multi-faceted and individual.

bmwusa.com/byo

Overview

BMW 6 SERIES AT A GLANCE.

- 64 Build Your Own**
- 65 Technical data**
- 68 BMW Services**
Exclusive offers for BMW customers.

bmwusa.com

For exclusive BMW photos, behind-the-scenes videos and the latest BMW news:

 Like us on Facebook®:
facebook.com/bmwusa

 Follow us on Twitter®:
twitter.com/bmwusa

 Find us on YouTube™:
youtube.com/bmwusa

 Follow us on TUMBLR®:
bmwusa.tumblr.com

Get the latest information on BMW standard and optional features, packages and technical specifications. Visit bmwusa.com, select the BMW model of your choice, and click on "Features & Specs."

Editorial

REDEFINING THE EQUATION FOR 2+2.

The concept of the 2+2 has been with us for decades. Defined, it's a two-seat sports car with two more seats – two plus two. It's for those who want a thrilling driving experience without fully compromising practicality.

That is the definition. Now we present the redefinition: the BMW 6 Series Coupe and Convertible.

On the thrilling driving side of the 2+2 equation, our engineers and designers have honed the BMW 6 Series' sporting character to a fine edge. Outside, a long, low and wide body flashes an aggressive yet graceful stance. Under its long hood we offer you a choice of heart-pounding power sources: a 315-hp TwinPower Turbo inline six or a 445-hp TwinPower Turbo V-8, both of which connect to the road via an 8-speed Sport Automatic transmission with fast-acting steering wheel-mounted paddle shifters.

On the practical side you'll discover a full range of standard and optional driving systems to keep you firmly in control, fully informed, richly entertained and sumptuously comfortable. This includes BMW ConnectedDrive for fast access to Google Maps™-assisted navigation, full-color Head-up Display, Advanced Real Time Traffic Information (ARTTI) and more. On the entertainment side you can select a nine-speaker HiFi audio system, or an available Bang & Olufsen® High-End Surround Sound System especially designed for the 6 Series. Each delivers sparkling audio range and presence while you listen in the supple comfort of a lovingly crafted and exquisitely detailed interior.

The ultra-advanced and elegantly refined BMW 6 Series Coupe and Convertible take the 2+2 driving experience to the next level. Now the only element missing from the equation is you.

bmwusa.com/6series

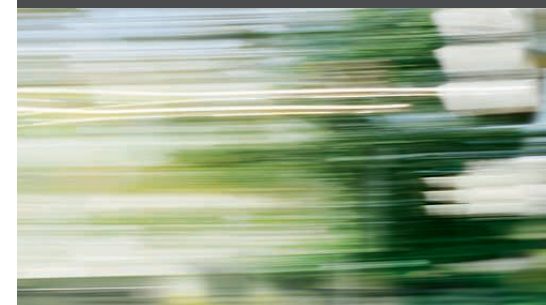

AN ATHLETIC SOUL, ELEGANTLY EXPRESSED.



Long, wide, low and muscular. We've made the sporting character of the BMW 6 Series an emphatic statement. Its flowing lines frame a gracefully athletic stance. The front end area features the signature BMW double-kidney grille, flanked by four Corona headlight-rings that frame the available Full LED headlights with Adaptive and Automatic high beams functionality. All curved surfaces and character lines are sharply defined and tightly curved to create an elegant, elongated silhouette. Bulging wheel arches frame the striking alloy wheels, a visual manifestation of dynamic road-holding ability. The effect: breathtaking.

Get the latest information on BMW standard and optional features, packages and technical specifications. Visit bmwusa.com, select the BMW model of your choice, and click on "Features & Specs."

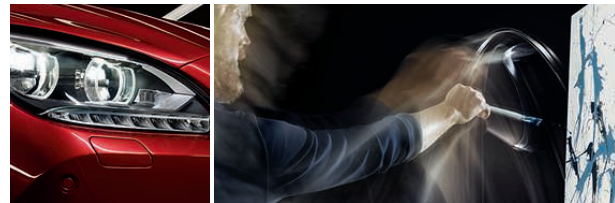

A masterpiece down to the smallest detail: the long side line draws your attention to the Full LED foglights, which give the front of the vehicle even more impressive character.

**YOU'VE NEVER FELT POWER
IN THIS WAY.**



Power as an extension of your desires: an 8-speed Sport Automatic with steering wheel-mounted paddle shifters sprints you forward.



We creatively engineer power to a standard of how it feels to the driver. Let us explain. Do you feel power instantly? Do you feel power flowing smoothly yet decisively throughout the acceleration event? Do you feel in control of power delivery? Indeed, the BMW 6 Series' raw power is impressive. Choose 315 hp from a TwinPower Turbo inline six-cylinder or 445 hp from a TwinPower Turbo V-8, transmitted through an 8-speed Sport Automatic transmission with steering wheel-mounted paddle shifters.

Get the latest information on BMW standard and optional features, packages and technical specifications. Visit bmwusa.com, select the BMW model of your choice, and click on "Features & Specs."

ON THIS STAGE, THE CAR SUPPORTS THE STAR – YOU.



BMW ConnectedDrive makes everyday driving easier. In the BMW 6 Series Coupe and Convertible, innovative assist systems are focused on you, the driver – connecting you, the vehicle and the road. A full-color Head-up Display streams relevant data, such as your speed, Navigation system instructions, even warning messages from driver assistance systems, directly onto the windshield, helping you keep your eyes focused on the road. And when you arrive, not only can the Parking Assistant feature tell whether you'll fit into a parking spot – it can even do the parking for you.

Get the latest information on BMW standard and optional features, packages and technical specifications. Visit bmwusa.com, select the BMW model of your choice, and click on "Features & Specs."

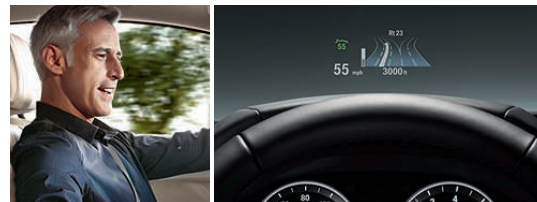

Enjoy the road ahead with the full-color Head-up Display that projects vital driving data into clear view.

ZERO TO SKY IN 19 SECONDS.



Forward-thinking rear window: the glass rear window can be raised or lowered with a touch of a button – independent of the softtop – for customized ventilation on demand.



The BMW 6 Series Convertible takes the softtop to new heights. BMW advances convertible softtop technology in several ways. The first is how quickly it operates, retracting in 19 seconds and closing in 24 seconds, all while traveling up to 25 mph. Next is flexibility and comfort: the upright heated glass rear window can be raised and lowered electrically – and independently of the softtop. This allows for what our engineers call a “California” mode: driving top-up with the rear window down. You’re protected from the sun while the open side and rear windows allow a generous flow of fresh air. Trust BMW to present sun and sky in a whole new way.

RIDE AND HANDLING THAT MOVE YOU IN MORE WAYS THAN ONE.



Enjoy a unique combination of sporting performance and comfort. Confidence-inspiring handling without a harsh ride is always our engineering mandate. Expect nothing less in the BMW 6 Series. Dynamic Damper Control delivers the precise amount of ride control to match your unique driving style and road conditions. Electro-hydraulic brakes instantly activate a range of technologies to help keep you in control, whether slowing on wet or dry roads. Integral Active Steering adapts steering effort to you, not the other way around, and enhances cornering geometry by adding rear-wheel steering. Dynamic Stability Control anticipates slides before you feel them and corrects them in a flash, while Dynamic Traction Control minimizes wheelslip on slick surfaces. BMW's xDrive intelligent all-wheel-drive system reads the road and reacts instantly to your driving demands. Sound intriguing? These are merely a few of the countless intelligent chassis control systems that go into this version of The Ultimate Driving Machine.®

Get the latest information on BMW standard and optional features, packages and technical specifications. Visit bmwusa.com, select the BMW model of your choice, and click on "Features & Specs."



Enjoy spirited driving with precision and confidence, thanks to BMW's array of innovative, intelligent chassis systems and driver aids.

ADVANCED INFORMATION TECHNOLOGY COMES IN A SMART PACKAGE.



Sleek, jewel-like turn indicators brilliantly announce your intentions to other drivers.



Stay totally informed. In the BMW 6 Series Coupe and Convertible, an advanced network of systems provides up-to-the-second vital information. BMW ConnectedDrive® systems can be monitored and controlled through a large, free-standing, 10.2-inch flatscreen Display. This includes Google Maps™-assisted Navigation with Advanced Real Time Traffic Information, BMW Assist eCall™ infrared BMW Night Vision with Pedestrian Detection, Rear-view Camera and more. No matter where you are, we're with you all the way.

Get the latest information on BMW standard and optional features, packages and technical specifications. Visit bmwusa.com, select the BMW model of your choice, and click on "Features & Specs."

**INDULGE YOUR PASSION
WHILE PRESERVING THE ENVIRONMENT.**



BMW EfficientDynamics: solutions to sustainability challenges. BMW owners love driving – and the environment in which they drive. The aerodynamic BMW 6 Series satisfies these demands by combining high performance with low fuel consumption and emissions. The entire drivetrain, from engine to transmission, bristles with high-efficiency technologies – electronically controlled engine cooling is just one innovative example. Another is the 8-speed Sport Automatic transmission that makes the most of the engine's power in all gears. The drivetrain even enhances efficiency every time you take your foot off the accelerator: kinetic energy lost when coasting or braking is converted into electrical power via Brake Energy Regeneration.

Get the latest information on BMW standard and optional features, packages and technical specifications. Visit bmwusa.com, select the BMW model of your choice, and click on "Features & Specs."



Sustainability and precision are achieved through an advanced array of innovative technologies.

LIGHT UP THE FUTURE.

The BMW 6 Series is a showcase for Full LED headlights with Adaptive and Automatic high beams functionality. Their bright white light is an active safety feature that helps make every journey more comfortable. Thanks to the unique light design and distinctive profile, you not only see better in the dark, but are more visible to other drivers.



Good vision is one of the most important requirements for steering safely through traffic. To experience this at night, you need high-power, high-contrast light.

The lighting concepts produced by BMW have always been a little brighter than those of other manufacturers. Just under 20 years ago, the BMW 7 Series was the first to offer

headlights using Xenon technology. These HID (High-Intensity Discharge) lights provide daylight-like brightness to illuminate the street with double the luminosity of standard halogen headlights. And now this brilliant technology is followed by the latest in lighting: LED systems.

The BMW 6 Series Coupe and Convertible offer Full LED headlights with Adaptive



Low and high beams can be generated by available LED technology. As with the Adaptive turning lights and Automatic high beams, the headlights follow the course of the road and adapt to traffic conditions.

and Automatic high beams functionality, providing a new visual experience. Light-emitting diodes (LED) are used in the parking lights, Daytime Running Lights, high and low beams, turn-indicator lights and Cornering Lights. Additionally, the LED headlights incorporate the functionality of Adaptive turning lights and integrated Automatic high beams. Pivoting light cones provide extra visibility in corners; illumination levels change, as appropriate, for city driving, country roads and highways.

The key difference between LED lights and the bright bluish arcs of Xenon lights or the yellowish hue of conventional halogen lamps is the extremely white light typical of LED technology. No other car lights approximate natural daylight so effectively. As a result, drivers find this light even brighter, with more intense contrast, than the already superb Xenon technology.

Experts, such as BMW light engineer Ulrich Henseler, predict that these light diodes have a bright future ahead of them. "The light-emitting efficiency of LED technology has increased in just a few years from 50 to just under 100 lumens per watt. LEDs also score high because they have an almost unlimited shelf life and their properties open up new design opportunities."

In the BMW 6 Series Coupe and Convertible, the headlight design symbolizes athletic elegance. The light architecture behind the dynamically curved glass is also unique in terms of functionality. Here, Full LED head-

lights with Adaptive turning lights are being used in a distinctively sporty BMW design. The light-surrounds are three-dimensional, and flattened at top and bottom. Double-round headlights project the LED low and high beams from two Corona headlight-rings. The shortened accent lights are similar to a pair of eyebrows; at night they produce a unique, signature look – one that makes the 6 Series Coupe and Convertible seem even more focused and purposeful.

Get the latest information on BMW standard and optional features, packages and technical specifications. Visit bmwusa.com, select the BMW model of your choice, and click on "Features & Specs."



HIDDEN BEAUTY.

A light installation by Paul Cockledge for BMW and Flos.

As part of the Milan Salone del Mobile 2011, BMW and designer light company Flos presented a very special, innovative project.

The British designer Paul Cockledge was commissioned to create the fascinating light installation, "Sesto Senso." The focal point was the allure of the unseen – namely BMW LED technology and the BMW 6 Series Coupe. Cockledge installed a seamless, curving white wall extension to the Flos showroom in Milan, featuring huge lamps. Thanks to LED technology, the light sources within each lamp remained largely invisible. Observers were able to step into the lamps and, from there, see a video of the BMW 6 Series Coupe.

Because of its strong emotional significance and relation to the driving experience, lighting design has always been given a high degree of importance within the BMW Group. The BMW Design team focuses on human perception of light, harnessing new technologies in a creative way to achieve user-oriented solutions. As for inspiration and ideas, cooperation with designers and artists has a significant role to play for BMW.

IT'S AS IF IT WERE CUSTOM-MADE FOR YOU.



Slip into the driver's seat to be instantly impressed at how natural it feels. This is not by chance. BMW designers and engineers pay particular attention to even the most minor details. From the dramatic Ambiance interior lighting, to the strategically arrayed and angled instrumentation, to the lovingly selected materials that delight to the touch, this cabin is designed to keep you comfortably in control – and entertained. Beyond our already exceptional standard HiFi audio, you can select a Bang & Olufsen® Surround Sound System for your BMW 6 Series. It's the perfect aural complement to the visual and tactile delights of this stunning interior.

Get the latest information on BMW standard and optional features, packages and technical specifications. Visit bmwusa.com, select the BMW model of your choice, and click on "Features & Specs."

A match made in heaven: the 1200-watt Bang & Olufsen High-End Surround Sound System in the 6 Series is precisely matched to the unique acoustics of the interior. The effect is pure heaven for audiophiles who love to drive.



HERE, DRIVER AND PASSENGERS BECOME HOST AND GUESTS.



Contrast stitching throughout the cabin displays the loving care with which this interior is crafted.



This is one 2+2 in which everyone enjoys the ride. In this welcoming environment you can see and feel the extraordinary craftsmanship in every detail. The 20-way adjustable Multi-contour front seats with ventilation are surrounded by the beauty of natural wood trim. With the Convertible's top down, even the darkest Nappa Leather seats stay cooler, thanks to Sun-Reflective Technology. Further enhancing cabin comfort, the climate control system adapts to the individual needs of the driver and all passengers. Is everyone comfortable? Perfect. Let's go for a drive.

Get the latest information on BMW standard and optional features, packages and technical specifications. Visit bmwusa.com, select the BMW model of your choice, and click on "Features & Specs."

BMW ConnectedDrive So connected, you're free.



Every day, our world is becoming increasingly networked. Many BMW drivers, however, are better connected than the rest, obtaining information on the road, communicating by phone or email, and always being updated on the latest events. BMW ConnectedDrive encompasses all these services, including traffic features that allow BMW vehicles and their occupants to network with the outside world.



BMW ConnectedDrive services and apps provide versatile connections between the driver, vehicle and the outside world. BMW ConnectedDrive driver assistance systems enhance your convenience, active safety and peace of mind. BMW ConnectedDrive infotainment features make every mile even more enjoyable. And most are easily accessed and controlled through the on-board iDrive system with touchpad Controller, literally putting the world at your fingertips.

For more information, please see:

➔ bmwusa.com/connecteddrive

BMW CONNECTED DRIVE®: CONVENIENCE, INFOTAINMENT AND SAFETY TECHNOLOGIES MEET IN ONE SUITE.

With BMW ConnectedDrive you stay in touch, no matter where you go. Its advanced communications and entertainment features create a network between driver, vehicle and environment, at any time and wherever you are. The following pages present special highlights in the areas of convenience, infotainment and safety. For a comprehensive overview, see bmwusa.com/connecteddrive.



BMW ASSIST eCALL™

Enjoy peace of mind knowing that a friendly response specialist is there to help you 24/7, at the touch of a button. BMW Assist eCall includes Automatic Collision Notification, Emergency Request (SOS button) and Customer Relations.



BMW TELESERVICE.

As you're driving, the intelligent maintenance system, Condition Based Service, constantly monitors your vehicle's service needs. BMW Teleservice checks your vehicle's operating fluids and wear items. When any need replacing, it automatically transmits this data and upcoming service needs to your preferred BMW center. Your BMW Service Advisor then contacts you to set up a convenient appointment, and orders parts beforehand, reducing your service and wait time.



BMW ONLINE.

BMW Online gives you a personalized internet portal, delivered on the Control Display. Get up-to-date fuel prices and gas station locations; the latest weather forecasts, advisories and warnings; Dow Jones, S&P and NASDAQ indices; and the powerful reach of the Google® database. Read or hear news headlines aloud via text-to-speech technology. "Send to Mail" pinpoints your current location and planned destination, and allows you to send the information to any email account. Split-screen functionality lets you use BMW Online in tandem with Navigation maps and instructions, entertainment details and other on-board content.

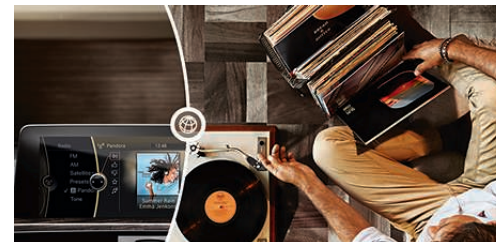

BMW APPS.

Access Social Networks, on-demand music and location sharing through your iPhone®, and see them on the Display screen.¹ Tune in to Web radio and search for stations from around the globe by name, location or genre. You can also store your favorite stations, find similar stations, display station information, and change the quality of the audio. Your favorite entries are on your iPhone, so you can take them from one vehicle to another.

- ¹ Requires BMW Apps option and a compatible phone. Please note:
- A broadband data link is required. The costs for this (e.g., data roaming) are regulated by the customer agreement with the mobile phone service provider.
 - Not all features available while vehicle is in motion; see dealer for details.
 - Web radio audio quality depends on the bit rate of the station, and data reception depends on your cell service. Data transfer comes over the mobile device.

Get the latest information on BMW standard and optional features, packages and technical specifications. Visit bmwusa.com, select the BMW model of your choice, and click on "Features & Specs."

BMW CONNECTED DRIVE® SERVICES AND APPS: EVERYTHING YOU NEED, INTELLIGENTLY NETWORKED.

Want to find the quickest route around a traffic jam? Not a problem – if you have the BMW Navigation system with Advanced Real Time Traffic Information. Need to send a note to your client? Message Dictation lets you compose and send an email or text message while you concentrate on the road. Tired of the same old playlist? Let the AUPEO! Personal Radio app introduce you to a new world of music. How about finding a French restaurant in a strange city? Let Concierge Services locate it, make a reservation for you, and send the address and phone number directly to your BMW's Navigation system. **BMW ConnectedDrive** services and apps bring a whole new level of convenience and pleasure to your drive wherever you are.

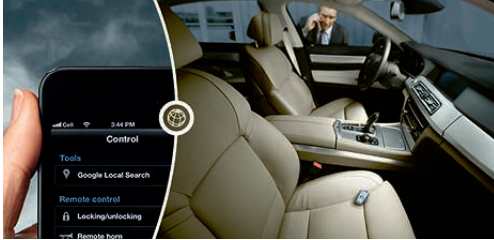

REMOTE SERVICES.

You're never far from your BMW when you have Remote Services. Locked out? Simply call the BMW Assist™ Response Center and they will unlock your driver-side door. If your BMW is stolen, file a police report, then call the BMW Assist Response Center; they will help the police locate your vehicle. (Check with your insurance company to see if this feature qualifies for a premium discount.) With the My BMW Remote app you can control your BMW from your smartphone. Lock your doors remotely; if you can't find your BMW in a parking lot, your screen will pinpoint it on a map – and on some models, even flash its lights.



ADVANCED REAL TIME TRAFFIC INFORMATION (ARTTI).

This feature, included in the iDrive 4.2 Navigation system for Model Year 2014, makes you aware of traffic congestion in most large cities before you encounter it. This feature displays and describes current local traffic information on your Control Display; in case of delays greater than five minutes, it suggests alternate routes. The latest-generation Navigation system offers numerous upgrades, such as presenting menus in virtual, 3-D spaces; added functions in the split-screen Display; switching quickly from top view to perspective view; using superimposed layers for Advanced Real Time Traffic Information and weather icons; displaying points of interest, and more.



MOBILE OFFICE.

Use the time you spend in your vehicle even more effectively with BMW's Mobile Office feature.¹ For example, text messages and emails can be transferred from your Bluetooth® paired phone directly to the vehicle's Control Display and can be read back to you aloud using text-to-speech functionality and the vehicle's audio system.

¹ Not all mobile phones are compatible with Mobile Office, and some compatible phones support a limited number of Mobile Office functions. For the complete list of compatible mobile phones and the details regarding which Mobile Office functions are supported by each phone, please visit bmwusa.com/bluetooth.

CONCIERGE SERVICES.

Wherever you travel, friendly Concierge Services representatives assist you with local restaurant and hotel recommendations, movie times and ticket information, flight arrival and departure gates and times, fuel prices and availability, and much more. You can also get the "Points of Interest" (POI) download, which allows the representative to send addresses and phone numbers to your vehicle. This information can also be transferred to your BMW Navigation system for route guidance. Then use your Bluetooth linked mobile phone to make a call.



DRIVER ASSISTANCE FEATURES: DESIGNED TO ENHANCE YOUR BMW DRIVING EXPERIENCE.

Driving a BMW isn't always the thrill of taking tight corners and accelerating onto a highway. There are the more mundane tasks of, say, finding and maneuvering into a parking space, or exiting an indoor garage onto a busy street and avoiding pedestrians you cannot see. For those times, innovative **BMW ConnectedDrive** driver assistance features make every moment behind the wheel as effortless and enjoyable as possible.



HEAD-UP DISPLAY.

The BMW Head-up Display uses a multi-color TFT to project the image toward the windshield more in your line of vision, so you can easily keep your eyes on the road while checking important travel information, such as your current speed, Check Control data and Navigation system directional arrows.



PARKING ASSISTANT.

This driver assistance system searches for suitable parking spots and then steers your vehicle into them. Simply press the "Park Assistant" button, then drive along potential parking spaces on either side of the road, staying below 22 mph and no more than five feet away. Using ultrasonic sensors integrated into the side indicators, the system searches for and measures parking spaces. When a space at least four feet longer than your vehicle is spotted, it is shown on your Control Display. Shift into reverse and Parking Assistant takes control of steering your vehicle into the selected space; you operate the accelerator and brake pedals. The acoustic and visual warnings of Park Distance Control provide assistance.

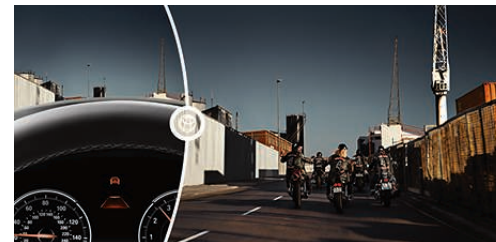

DRIVING ASSISTANCE FEATURES.

Numerous BMW ConnectedDrive features help enhance active safety. For example, when your vehicle crosses over lane markings without signaling, **Lane Departure Warning**, a component of Active Driving Assistant, warns you by sending a mild vibration through the steering wheel. **Active Blind Spot Detection**, activated when you use the turn-signal indicator before changing lanes, warns if a vehicle is in your blind spot or approaching at a high speed in the passing lane. Part of Active Protection, **Attention Assistant** analyzes your driving behavior, based on steering angle, road speed and other parameters. If the system detects telltale signs of fatigue starting to build up, the Control Display will show a coffee cup – encouraging you to take a break.



BMW NIGHT VISION WITH PEDESTRIAN DETECTION.

This feature can scan up to 900 feet ahead using an infrared camera in the front bumper. It can detect people, as well as the direction of their movement, up to approximately 300 feet away and displays their presence on the iDrive screen and Head-up Display. The system gives a visual warning when pedestrians move toward the road, alerting you to potential dangers significantly earlier so you can react more quickly.

Get the latest information on BMW standard and optional features, packages and technical specifications. Visit bmwusa.com, select the BMW model of your choice and click on "Features & Specs."

BMW EfficientDynamics

Less emissions. More driving pleasure.

BMW is passionate about researching and developing systems that ensure advanced and efficient mobility. Which is why the BMW 6 Series Coupe and Convertible, like every BMW, come with comprehensive, multi-award-winning BMW EfficientDynamics technology. BMW EfficientDynamics innovations reduce fuel consumption and CO₂ emissions while maximizing engine output and dynamic performance. Less fuel, more driving pleasure – a contradiction that BMW has resolved once and for all.



BMW EFFICIENT DYNAMICS: MAKING A LITTLE GO A LONG WAY.

Under the umbrella of the BMW EfficientDynamics project, BMW is continuously developing innovative systems that will bring us closer to the goal of emissions-free driving in the long term.

Eco-friendly technology. The development of more efficient vehicles powered by conventional gasoline and diesel engines are continuing challenges. A comprehensive technology directive enables the reduction of fuel consumption and emissions, while at the same time increasing power output and driving enjoyment. These advances are based on innovations such as BMW TwinPower Turbo technology, Brake Energy Regeneration, Air Curtain front apron design, and many others.

BMW ActiveHybrid. With the BMW ActiveHybrid 7, BMW ActiveHybrid 5 and BMW ActiveHybrid 3, BMW has impressive hybrid production models in its line. All combine outstanding efficiency with superlative dynamic ability.

BMW i. The all-new BMW i brand is launching two completely new vehicle concepts for sustainable mobility in an urban environment; both are an important part of BMW EfficientDynamics technologies. Key features of the BMW i3 and BMW i8 include the use of lightweight materials such as carbon-fiber-reinforced plastic (CFRP), electric drive systems, powerful battery technology and eco-friendly production methods.

bmwusa.com/i
bmwusa.com/EfficientDynamics

THE BMW 6 SERIES COUPE AND CONVERTIBLE EFFICIENT DYNAMICS INITIATIVE AT A GLANCE.

BMW TwinPower Turbo technology.

This innovative turbocharging technology efficiently reclaims the energy contained in exhaust gases, using two turbochargers in the BMW 650i, or a twin-scroll charger with a double-flow exhaust system in the BMW 640i.

High Precision Direct Injection.

In this latest-generation direct fuel injection system, the piezo injectors are positioned very close to the spark plugs. They inject fuel at high pressure, with extreme precision, for very efficient combustion.

Double-VANOS valve timing.

BMW's VANOS valve timing system "steplessly" varies the points in the combustion cycle when valves open and close. Double-VANOS refers to the fact that it operates on both the intake and exhaust camshafts. Electronically controlled in response to engine speed, temperature and load, it reduces emissions, and enhances low- to medium-speed torque, as well as fuel efficiency.

8-speed Sport Automatic transmission.

The close spacing of gear ratios in this 8-speed Sport Automatic transmission makes maximum use of the optimum rev range, reducing fuel consumption and allowing smoother shifts.

Auto Start-Stop function.

An idling engine burns fuel unnecessarily. The Auto Start-Stop function enhances fuel efficiency by switching off the engine when the vehicle is not moving. (The intelligent electronics system first checks the battery charge level and calculates if other electric systems, such as the air conditioning or heated rear windshield, require more energy.) Once the footbrake is released, the engine starts up again almost instantly.

Optimized fuel efficiency.

BMW EfficientDynamics enables every BMW engine to provide maximum power while using a minimum of fuel. In the BMW TwinPower Turbo V-8 engine, two parallel turbochargers are positioned between the cylinder banks. This compact design with shorter intake paths provides power and performance at a previously unattainable level.

Brake Energy Regeneration.

In vehicles with Brake Energy Regeneration, the alternator generates electricity only when the driver takes his or her foot off the accelerator. Kinetic energy that was previously unharnessed is transformed into electrical energy, which is then fed into the battery. In this way, electricity is generated without consuming fuel.

Not all BMW EfficientDynamics features are available on all models. Please see your authorized BMW center for details.

BMW ENGINE TECHNOLOGY: A HERITAGE OF INNOVATION. A FUTURE OF SUSTAINABLE EXHILARATION.

From its inception almost a century ago as a manufacturer of aircraft engines, Bavarian Motor Works has been a world leader in engine design. In fact, the innovations shown below were so ahead of their time, BMW engineers still incorporate this technology into today's award-winning powerplants. Over the decades, BMW engines have led to countless wins at the racetrack. Even more important, their smooth, powerful and efficient performance has won over generations of driving enthusiasts. Today, adhering to the EfficientDynamics philosophy, BMW engineers are setting even higher goals: creating an engine template that can be scaled in size and adapted to new fuel sources – all while maintaining legendary BMW performance and efficiency. It's a revolutionary concept that is now becoming reality. Welcome to the exciting future of BMW power.

1936



SEMI-HEMISPHERICAL VALVE DESIGN.

A design so advanced it helped the BMW 328 Mille Miglia win races in 1936 – and it's still in use today.

1955

ALL-ALUMINUM V-8 ENGINE.

The BMW 502 applied what is now called "intelligent lightweight engineering" to its then-awesome 160-hp V-8 engine.

1972

FUEL INJECTION.

The BMW 2002tii featured fuel injection, a technology that would become a crucial building block in BMW EfficientDynamics advances.

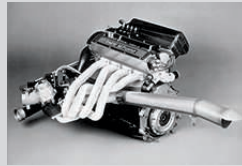

DIGITAL MOTOR ELECTRONICS (DME).

Computerized engine monitoring and control revolutionize the performance, efficiency and reliability of BMW's World Championship-winning Formula 1® racecar.

1981

1992

MULTI-VALVE TECHNOLOGY.

In every BMW, four valves per cylinder let in more air for greater power, and push out exhaust more easily for greater efficiency.

2006



ALUMINUM/MAGNESIUM COMPOSITE ENGINE BLOCK.

Technology from 1970s BMW racecar engines, this combines the strength to withstand high-revving performance with efficiency-enhancing light weight.

2007

TWIN POWER TURBO ENGINES.

BMW twin-scroll turbocharging calls on high-precision direct injection and a host of other innovations for increased power and efficiency – without turbo lag.

2008

BMW ADVANCED DIESEL WITH BLUE PERFORMANCE TECHNOLOGY.

BMW introduces America to a new form of diesel with amazing torque and power, quiet running, lower emissions and greater efficiency than ever before.

TODAY: THE BMW TWIN POWER TURBO ENGINE.

Introduced in 2007, TwinPower Turbo technology is incorporated into every new BMW engine, whether gasoline-, diesel- or hybrid-powered. Utilizing BMW high-precision direct injection, Double-VANOS continuously variable camshaft timing, and Valvetronic individual intake valve control, TwinPower Turbo technology delivers vastly increased power, torque and efficiency when compared to normally aspirated engines of the same size.

BMW GASOLINE-POWERED ENGINES.

Whether configured with four, six, eight or 12 cylinders, the latest BMW gasoline-combustion engines are designed to generate the highest ratio of power and thrilling performance to fuel consumption and emissions.

BMW ADVANCED DIESEL.

Powerful, fast, quiet and fuel-efficient: these are the traits of BMW Advanced Diesel engines. Thanks to BluePerformance Technology, BMW diesel engines meet emissions standards in all 50 states. Managed by a high-performance electronic engine control unit, the turbocharger develops boost and extra power in immediate response to the smallest tap of the accelerator pedal, and stays strong throughout the rev range where you do most of your driving.

BMW ACTIVE HYBRID.

BMW ActiveHybrid vehicles blend a TwinPower Turbo engine with an electric motor and high-performance lithium-ion battery. When compared to non-hybrid versions, BMW ActiveHybrid vehicles deliver greater fuel efficiency, fewer emissions and breathtaking acceleration.



BMW i: BORN ELECTRIC.

BMW i makes its debut with the i3. Powered by an electric motor combined with an innovative lithium-ion battery, the i3 accelerates from 0–60 in approximately 7 seconds. The BMW i8, a plug-in hybrid electric vehicle, races from 0–60 mph in 4.4 seconds. Its 131-hp electric motor powers the front wheels, while a 231-hp three-cylinder gasoline engine turns the rear wheels. Capable of 22 miles of all-electric driving using its lithium-ion battery, it achieves a total average fuel consumption of 94 mpg and a top speed of 75 mph.

315-hp BMW TwinPower Turbo inline six-cylinder engine.



THE EVOLUTION OF BMW EFFICIENT DYNAMICS TECHNOLOGY.

Smaller engines that generate greater power using less fuel.

1994 BMW 530i

- 3.0-liter V-8 engine with 5-speed automatic transmission
- 215 horsepower
- 16 city/25 highway mpg¹
- 0-60 mph: 8.8 seconds²

2014 BMW 528i

- 2.0-liter inline four-cylinder TwinPower Turbo engine with 8-speed automatic transmission
- 240 horsepower
- 23 city/34 highway mpg¹
- 0-60 mph: 6.1 seconds²

¹ EPA-estimated figures are for comparison purposes only. Your actual mileage will vary, depending on speed, driving habits, trip length and driving conditions; actual mileage may be lower.

² BMW AG test results. BMW urges you to obey all posted speed laws and always wear safety belts.



Every BMW vehicle is engineered to provide the most thrilling and precise connection to the road. This is achieved through innovative axle technologies that increase stiffness front and rear, while reducing weight through the use of lightweight aluminum components. The BMW 6 Series' near-perfect 50/50 weight distribution offers strikingly well-balanced road feel, with responsive characteristics virtually unmatched by any competitor on the road today.



THE BEST FOUNDATION FOR DYNAMIC PERFORMANCE: A SUPERIOR CHASSIS.

The BMW 6 Series Coupe and Convertible can be equipped with a whole host of innovative technologies to help you get the most out of each drive. Many of these systems are intelligently networked with each other, maximizing your active safety quotient – and your driving pleasure.

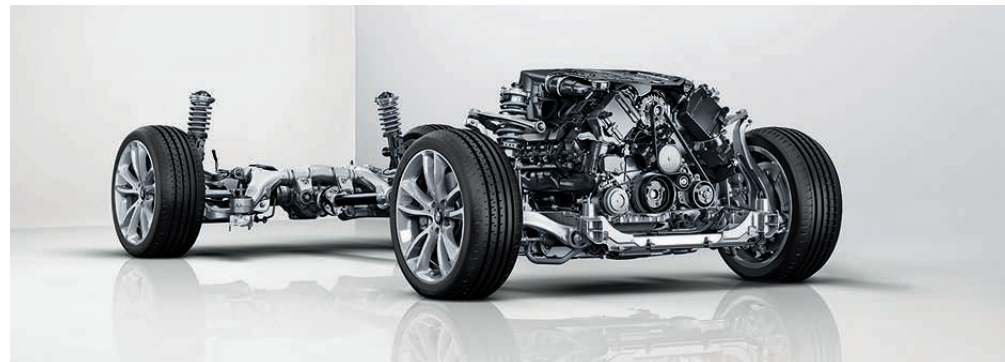

Integral Active Steering.

At speeds of up to 30 mph, with Integral Active Steering, a small turn of the steering wheel yields a greater turn of the front wheels for more direct response. This feature also steers the rear wheels up to 2.5 degrees in the opposite direction, giving the effect of a shortened wheelbase for enhanced maneuverability. When changing lanes at speeds over 50 mph, both front and rear wheels turn in the same direction, giving the feel of an extended wheelbase. While you experience greater responsiveness and directional stability, your passengers enjoy greater ride comfort from reduced body roll.

8-speed Sport Automatic transmission.

This transmission adjusts to your style – from comfortable cruising to very dynamic driving. To change gears, you can use the selector lever or steering wheel-mounted gear shift paddles. In Sport mode, modified clutch settings allow very quick adjustments in engine speed, for minimal shift times. The close spacing of the eight gears optimizes acceleration, while also maximizing efficiency and comfortable shifting.

Driving Dynamics Control including ECO PRO mode.

You can adjust the driving characteristics of the BMW 6 Series by simply pressing a button. To change engine-throttle response, transmission shift characteristics and power-steering assist, choose from five settings: COMFORT, COMFORT+, SPORT, SPORT+ or ECO PRO mode. In addition, the traction control feature can be disengaged when driving on sand, gravel, or deep or packed snow.

Adaptive Drive.

Adaptive Drive minimizes the tendency of the body to roll, enhancing passenger ride comfort and vehicle agility during sporty driving maneuvers. In constant operation while the vehicle is in motion, it includes Dynamic Drive, an active chassis control system that uses active stabilizers on front and rear axles to counteract body roll when cornering, especially at higher speeds. This helps ensure precise steering and balanced reactions to load changes.

Dynamic Damper Control.

Ride-enhancing Dynamic Damper Control instantly adjusts shock absorbers from the softest to the firmest settings. The result is exceptional ride comfort and fluid handling at all times – during changes in vehicle speed, load, or road and driving conditions.

xDrive intelligent all-wheel-drive system.

BMW's intelligent all-wheel-drive system in the 640i xDrive and 650i xDrive Coupe and Convertible models provides maximum traction, even in the most slippery conditions. The system monitors data such as engine speed, steering angle, wheel speeds and acceleration. On smooth, dry roads, more power is normally sent to the rear axle, giving vehicles with xDrive the feel of their rear-wheel-drive counterparts. But hit a wet uphill curve, for instance, and even before wheel-spin can occur, the system immediately recognizes any need for a change in power distribution. Using a controlled clutch, it sends more torque to the front axle to enhance stability and achieve greater traction.

Get the latest information on BMW standard and optional features, packages and technical specifications. Visit bmwusa.com, select the BMW model of your choice, and click on "Features & Specs."

HIGH-TECH BODYGUARDS: ACTIVE AND PASSIVE SAFETY.

The 6 Series is designed with BMW's full range of standard state-of-the-art active and passive safety technologies. Active safety features, such as Xenon Adaptive Headlights, powerful engines and large brakes, help you see and respond to potentially dangerous situations. Should the vehicle detect an imminent accident situation, Active Protection pulls front safety belts tight and closes the windows – and, in the 6 Series Coupe, the moonroof. Should an accident prove unavoidable, the system automatically applies the brakes. Other passive safety features, such as airbags – and in the BMW 6 Series Convertible, Rollover Protection – are designed to help protect you and your passengers. After a severe impact, a host of features spring into action: the doors automatically unlock, headlights and taillights flash, the starter cable is disconnected from the battery and the fuel supply is cut off. Should any airbags deploy, BMW Assist eCall™ response specialists are automatically alerted and notified of your location.



Dynamic Stability Control (DSC). This system provides remarkable tenacity on slippery road surfaces. If it senses over- or understeer, it modulates engine power and can apply brakes individually to help keep the vehicle under control and going in the intended direction. Start-off Assistant, a feature of DSC, prevents the vehicle from rolling backward on a hill for 1.5 seconds after taking your foot off the brake. The system also includes Brake Fade Compensation, which lets you use the same amount of pedal force, even when the brakes are heated; Brake Stand-by, which pre-tenses the brakes for quicker action if you suddenly remove your foot from the accelerator pedal; and Brake Drying, which periodically brings the brake pads into contact with the rotors to eliminate accumulated moisture when it rains.

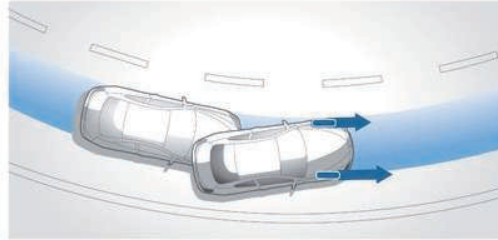

Dynamic Traction Control (DTC). This sub-function of Dynamic Stability Control raises the threshold for engine and braking intervention. Activated by simply pushing a button, this traction mode allows increased yet controlled wheelslip, helping to improve propulsion in deep snow or sand. When activated, it also provides an even sportier driving style.

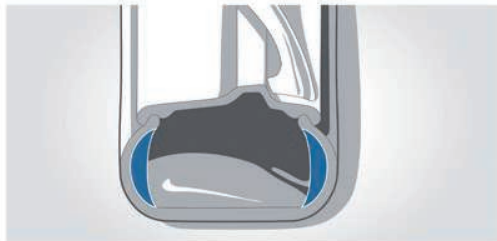

Run-flat tires. Thanks to reinforced sidewalls, run-flat tires maintain their shape and rim position even after suffering a complete loss of tire pressure. They allow you to continue driving at a reduced speed until you reach a safe area to change a tire or wait for Roadside Assistance. The Tire Pressure Monitor alerts you when there is a sudden and irregular drop in tire pressure. Should the target pressure of a tire fall below 25 percent, both a warning light and acoustic alarm are triggered.

Note: Please see the Owner's Manual for more information on run-flat tires that details allotted miles to travel and load weight rules.

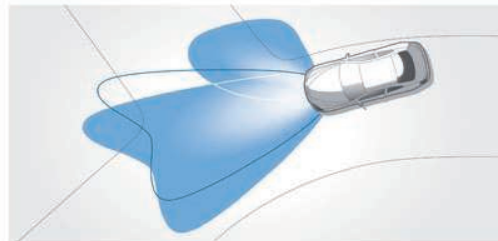

Xenon Adaptive Headlights for low- and high-beams enhance illumination of the road ahead at night or in poor visibility. Four LED Corona headlight-rings, which can be used as Daytime Running Lights, also serve as parking lights. Adaptive Headlights provide optimum illumination of the road ahead when the car enters a turn. Light distribution is automatically adapted to the road speed and steering angle. Cornering Lights, positioned in the two inner headlights, are automatically activated by using the turn indicator or changing the steering wheel angle, even when the vehicle is at rest.

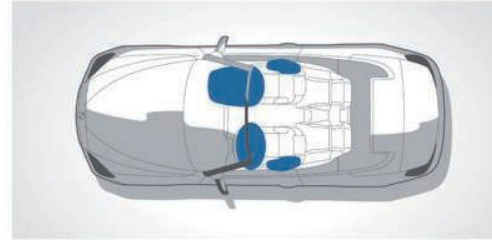

Airbags. In the event of a collision, BMW's supplemental restraint system (SRS) determines which airbag(s) to deploy for optimal protection. When a safety belt is used, airbags deploy only at a higher crash severity; the force of the deployment depends upon the severity of the impact. Four airbags offer specific protection: front airbags with advanced technology for driver and front passenger, and front-seat-mounted side-impact airbags.

Note: These pictures of airbags are for illustrative purposes only. Depending upon the type of accident, none, some or all airbags may deploy.

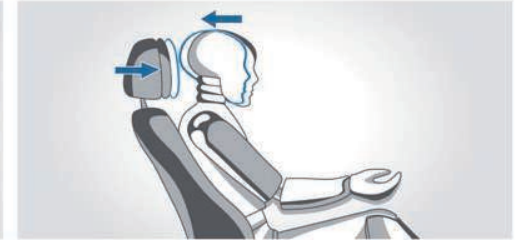

Active Head Restraints in the front seats reduce the risk of whiplash or neck/head/spine injury. When sensors detect a rear-end collision, the headrests rapidly and automatically pivot forward, supporting the driver's and front-seat occupant's heads.

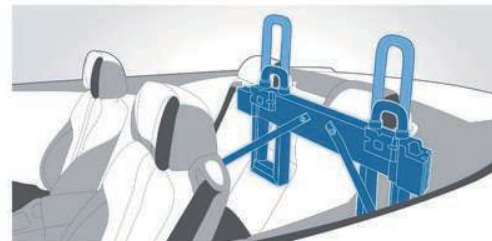

Rollover Protection System, together with the reinforced A-pillars and windshield frame, is designed to create an occupant "safety cell" in the BMW 6 Series Convertible. Highly accurate sensors continually monitor vehicle angle, longitudinal and lateral acceleration, and amount of ground contact. When data indicate a rollover is imminent, rollover bars integrated behind the rear-seat headrests are deployed. Within fractions of a second they spring up and lock into place, helping to withstand rollover forces.

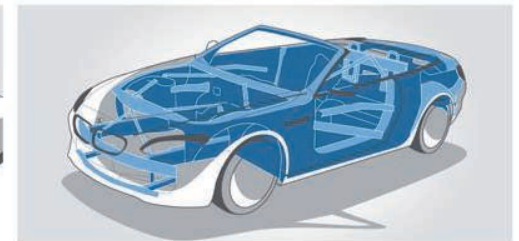

Body stiffness. The intelligent use of high-strength multi-phase steel and aluminum provides a high degree of body stiffness and crash resistance. Components, such as the A-pillars and windshield frame, include special reinforcements to provide optimum occupant protection.

THE ART OF KEEPING YOUR EYES WHERE THEY BELONG.



In addition to vehicle speed and Check Control data, the full-color Head-up Display can show Navigation system prompts, as well as warning messages from Active Driving Assistant and Night Vision with Pedestrian Detection system.



The full-color Head-up Display projects all important information in the driver's direct field of vision. This lets you keep track of everything that's happening on the road ahead.

The term "eyes-off-the-road time" means the amount of time it takes you to read information displayed in a vehicle's instrument panel, such as current vehicle speed and Navigation system instructions. Depending on the complexity of the data, eyes-off-the-road time can last between one and three seconds. However, in just two seconds, a car driven at 62 mph will have traveled a distance of 182 feet with the driver unable to pay full attention to what's happening on the road.

In 2003, BMW was the first European automotive manufacturer to offer a Head-up Display.

The concept of Head-up Display technology is to project essential information onto the windshield in the driver's field of vision. The projected image appears at an ergonomically ideal distance, seeming to hover above the front edge of the hood. The name of this technology speaks for itself: you can literally

keep your head up. The system allows you to keep an eye on key driving information while staying focused on the traffic ahead – so looking at the instrument panel is rarely necessary. Understanding data projected by the Head-up Display takes only half as long as reading them off the instrument panel. This minimizes the risk of missing the brake-lights of a vehicle ahead, as well as potential hazards in the roadway.

The display creates an optical illusion of hovering further out over the hood, to make focusing on traffic easier.

The Head-up Display projector is positioned behind the instrument panel. The image is projected onto the windshield, and reflected by it. To you, the driver, it does not appear on the windshield itself – instead it seems to hover outside the vehicle, at a distance of around two and a half feet. This virtual lengthening of the viewing distance makes reading data off the Head-up Display much easier than consulting the instrument panel. Your eyes do not have to adjust from near to far, or adapt from the well-lit road to the darker displays in the cockpit. This increases comfort and reduces eye strain.

The 6 Series Coupe and Convertible feature a full-color Head-up Display.

While previous versions of the Head-up Display showed only red, orange, yellow and green, the latest system can display the entire color range. In addition to vehicle speed and Navigation instructions, the Head-up Display can show warning messages from driver assistance systems, such as Speed Limit Info, Active Driving Assistant and the infrared BMW Night Vision with Pedestrian Detection. The Head-up Display greatly reduces eyes-off-the-road time, providing an important contribution to active safety. You can access the Head-up Display features and adjust brightness and image position via the iDrive Controller. As a result, you can react faster in extreme situations – and you'll be less prone to fatigue.



From the driver's point of view, the Head-up Display seems to hover above the front edge of the vehicle's hood.

Get the latest information on BMW standard and optional features, packages and technical specifications. Visit bmwusa.com, select the BMW model of your choice, and click on "Features & Specs."

Express yourself.



Let the BMW 6 Series Coupe reflect your true nature. Outside, your sport-tuned personality is expressed in the gleam of ultra-thin 20-inch V Spoke (Style 356) light alloy wheels and performance tires, set off by the subtle

glow of Mineral White Metallic paint. Inside, the warmth of Cinnamon Brown Dakota Leather rimmed with contrast stitching and Finesse Oak Wood trim reflect your sensuous side.

bmwusa.com/byo

Inner tranquility.



It's easy to remain unruffled in traffic. First, close the windows of your BMW 6 Series Coupe and immerse yourself in the superb sound system. Then fill your eyes with the beauty of the Ivory White Dakota Leather interior, tastefully set off by Finesse Oak Wood trim. Once you arrive at your

destination feeling rejuvenated, the exterior painted in rich Space Gray Metallic reflects your becalmed attitude. However, the gleam of aggressively styled 19-inch V Spoke (Style 366) wheels lets others know you can be a road warrior as well, should the need arise.



Wheel and tire specifications are subject to change. Get the latest information on BMW standard and optional features, packages and technical specifications. Visit bmwusa.com, select the BMW model of your choice, and click on "Features & Specs."

Dynamic character.



Your exciting first experience associated with the BMW 6 Series Convertible: selecting the exterior and interior colors and trim. Express your powerful passion by combining Black Sapphire Metallic paint and Black softtop with the fiery richness of Vermilion Red Extended Nappa Leather upholstery.

The Aluminum interior trim boldly anchors the vibrant colors, generating a look that's both dynamic and sophisticated. The addition of massive 20-inch V Spoke (Style 356) light alloy wheels with run-flat performance tires¹ rounds out the confident stance.



¹ Run-flat tires do not come equipped with a spare tire and wheel. Driving over rough or damaged road surfaces, as well as debris, curbs and other obstacles, can cause serious damage to wheels, tires and suspension parts. This is more likely to occur with low-profile tires, which provide less cushioning between the wheel and the road. Be careful to avoid road hazards and reduce your speed, especially if your vehicle is equipped with low-profile tires. Performance tires are not recommended for driving in snow and ice.

Elegant appearance.



A composition of pure style starts with rich Deep Sea Blue Metallic exterior paint, complemented by the warmth of supple Ivory White Extended Nappa Leather and Finesse Oak Wood interior trim. Add the supreme comfort of Active, ventilated, Multi-contour front seats to make every drive a pleasurable

event. The sleek exterior is enhanced by the gleam of 19-inch V Spoke (Style 366) light alloy wheels. The BMW 6 Series Convertible attracts many admiring glances, whether the triple-lined softtop is up, creating a coupe-like silhouette, or neatly folded inside the trunk.



Wheel and tire specifications are subject to change. Get the latest information on BMW standard and optional features, packages and technical specifications. Visit bmwusa.com, select the BMW model of your choice, and click on "Features & Specs."

The M Sport Package.

The M Sport Package puts the emphasis on the BMW 6 Series' athletic capabilities.

Equipped with the M Sport Package, the 6 Series revels in its serious performance side. Subtly reshaped by the Aerodynamic kit, the 6 Series takes on a more aggressive stance from the front air dam to the rear bumper. A choice of 19-inch or 20-inch alloy wheels takes full advantage of the greater cornering and performance capabilities of BMW's Adaptive Drive. Open the door and you are welcomed to the interior by the gleam of aluminum M door sills. Sit back and grab the thick M sport steering wheel. The racing-inspired ambiance continues overhead with an Anthracite Alcantara headliner in the 6 Series Coupe and, in the 6 Series Convertible, an exclusive Moonlight Black softtop.

Wheel and tire specifications are subject to change. Get the latest information on BMW standard and optional features, packages and technical specifications. Visit bmwusa.com, select the BMW model of your choice, and click on "Features & Specs."



M door-sill finishers with chrome inserts and the M logo perfectly complement the M Sport Package.



Three-spoke, leather-wrapped multi-function M sport steering wheel includes a thick, textured rim and thumb indents that are designed for performance driving.



Rear diffuser features a sporty bumper insert and dark chrome tailpipe frames.



Double Spoke (Style 373M)
20 x 8.5 front, 20 x 9.0 rear light alloy wheels with 245/35 front and 275/30 rear **run-flat¹ performance tires^{2,3}**.



Double Spoke (Style 351M)
light alloy wheels. With **run-flat¹ performance tires^{2,3}**: 19 x 8.5 front, 19 x 9.0 rear and 245/40 front, 275/35 rear tires. (Includes increased top-speed limiter.) With **run-flat¹ all-season tires²**: 19 x 8.5 wheels and 245/40 tires.



¹ Run-flat tires do not come equipped with a spare tire and wheel.

² Driving over rough or damaged road surfaces, as well as debris, curbs and other obstacles, can cause serious damage to wheels, tires and suspension parts. This is more likely to occur with low-profile tires, which provide less cushioning between the wheel and the road. Be careful to avoid road hazards and reduce your speed, especially if your vehicle is equipped with low-profile tires.

³ Performance tires are not recommended for driving in ice and snow conditions.

THE NEW M SPORT EDITION: MULTI-DIMENSIONAL EXCLUSIVITY.

Technical innovations and performance enhancements drive exhilaration to a whole new level.

The limited-production **6 Series M Sport Edition** raises the stakes in performance technology and sporting style. It starts with the extensive list of dynamic **M Sport Package** features, adds the conveniences and comforts of the **Executive Package**, then tops it off with desirable features, such as an instrument panel with elegant leather finish, ceramic controls, contrast stitching, and Full LED Headlights with Automatic high beams. Concierge Services and a Premium Hi-Fi System are added to 640i models; all models get the active safety features of **Driver Assistance Plus**. In addition to the (12) 6 Series paint options, Imola Red (shown below) and Carbon Black Metallic are offered only with the M Sport Edition or M Sport Package.



M door-sill finishers with aluminum inserts announce this is a special breed of 6 Series.



Adaptive LED Headlights for both high and low beams project an intense white light that simulates daylight for excellent visibility. **LED foglights** add a distinctive nighttime look.



Full-color BMW Head-up Display projects important travel information, such as current speed, Navigation instructions, Speed Limit Info and Check Control data onto the windshield, directly in your line of sight.



Dynamic Digital Instrument Cluster customizes the look of the instrument panel, based on your Driving Dynamics Control mode: COMFORT and COMFORT+, SPORT (shown) and SPORT+, or ECO PRO.

ALSO AVAILABLE ON REQUEST.

Personalize the luxurious look and feel of your M Sport Edition by adding exclusive BMW Individual paint finishes, BMW Individual Full Merino Leather upholstery, and BMW Individual Wood interior trim.



A sumptuous, sport-oriented cabin. This elegant interior is upholstered in BMW Individual Opal White Full Merino Leather. The M leather steering wheel offers secure grip while accentuating the interior's sportiness. Striking Sakhir Orange contrast stitching gives the leather-covered instrument panel a distinctive touch.



Multi-contour seats with supportive side bolsters can be adjusted for customized support.

Get the latest information on BMW standard and optional features, packages and technical specifications. Visit bmwusa.com, select the BMW model of your choice, and click on "Features & Specs."



powered by 

46 47 M Sport Edition

BMW Individual. The most exclusive way to drive a BMW.

For those who dream of a vehicle that reflects their own unique personality, there is BMW Individual.

The BMW Individual collection of exclusive paints, leathers and trims takes the BMW 6 Series to all-new heights of quality and luxury. Only the finest, perfectly matched materials are selected to create each expertly handcrafted interior.

BMW Individual exterior colors are noted for their brilliant, iridescent effects. One dramatic example is the Ruby Black Metallic paint finish. Under the light, it develops a dark red luminosity that seems to emanate from countless ruby pigments. This is beautifully set off by the lush BMW Individual Platinum/Black Full Merino Leather, giving the BMW Individual 6 Series a compellingly balanced character.

Or consider the BMW Individual 6 Series in Tanzanite Blue Metallic, which owes its name to tanzanite – a precious mineral distinguished by its perfectly clear dark blue crystals. In direct sunlight, this deep-blue finish is given a radiant glow by turquoise pigments beneath the surface. Juxtaposed against this extraordinary exterior is an interior upholstered in Full Merino Leather in Opal White. The naturally silky-soft, breathable surface of this fine-grain leather is rendered in an exquisite color inspired by the timeless elegance of Mediterranean yachts. BMW Individual White Ash Grain Wood trim, with its unique, delicately marbled finish, perfectly complements the light interior.



Wheel and tire specifications are subject to change. Get the latest information on BMW standard and optional features, packages and technical specifications. Visit bmwusa.com, select the BMW model of your choice, and click on "Features & Specs."

The BMW Individual 6 Series in Ruby Black Metallic paint.



V Spoke (Style 374) 20-inch light alloy wheels add an elegant gleam to the BMW Individual 6 Series exterior.



The exacting hand craftsmanship of BMW Individual is symbolized by the perfectly matched White Ash Grain Wood interior trim veneers.



Enjoy the rich look and feel of an interior swathed in Opal White Full Merino Leather.



Sink back into a sumptuous interior that extends all the way to the leather-covered dashboard.

The BMW Individual 6 Series in Tanzanite Blue Metallic paint.



Exterior colors.

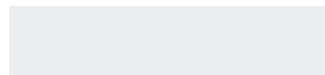

300 Alpine White (Non-metallic)



668 Jet Black (Non-metallic)



405 Imola Red (Non-metallic)



354 Titanium Silver Metallic



416 Carbon Black Metallic



475 Black Sapphire Metallic



A17 Mojave Metallic



A52 Space Gray Metallic



A76 Deep Sea Blue Metallic



A82 Vermilion Red Metallic



A92 Orion Silver Metallic



A96 Mineral White Metallic

Upholstery colors and materials.



LCEX Ivory White Dakota Leather



LCSW Black Dakota Leather

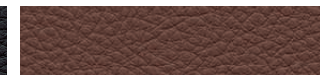

LCEZ Cinnamon Brown Dakota Leather



NABY Vermilion Red Extended Nappa Leather



NAEX Ivory White Extended Nappa Leather



NAEZ Cinnamon Brown Extended Nappa Leather



NASW Black Extended Nappa Leather

Contrast stitching.



4KS Vermilion Red contrast stitching



4KS Ivory White contrast stitching



4KS Cinnamon Brown contrast stitching

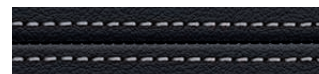

4KS Gray contrast stitching

The pages in this section of the brochure show available colors and materials for the BMW 6 Series Coupe and Convertible. Use these samples to compare paint, upholstery, trim colors and combinations. Please note that these samples are representations; they are not exact reproductions. To see the actual colors, visit your authorized BMW center. They will be happy to show you original samples.

For details on the availability of standard and optional exterior paints and upholstery materials and colors, please visit bmwusa.com/byo.

Leather upholstery: Leather on all seating surfaces; other components may be Leather or SensaTec.

Contrast stitching matches seat color, except for Gray contrast stitching with Black Nappa Leather upholstery.

Softtop colors.



388 Black



3YA Moonlight Black

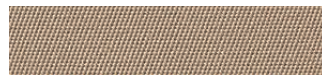

3YE Beige

Interior trims.



4AS Gray Poplar Wood



4B9 Aluminum



4CV Fine Line Oak Wood

Exterior colors.



BMW Individual

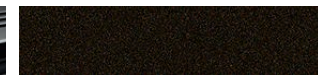

X02 Citrin Black Metallic



X03 Ruby Black Metallic



X10 Tanzanite Blue Metallic

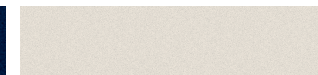

X04 Moonstone Metallic



X11 Frozen Bronze Metallic

Interior trims.



BMW Individual



XEX White Ash Grain Wood



XE5 Dark Red Sycamore Wood



XE7 Piano Black

Upholstery colors and materials.



BMW Individual



ZBOW Opal White Full Merino Leather



ZBC8 Platinum/Black Full Merino Leather



ZBP6 Champagne Full Merino Leather



ZBP5 Amaro Brown Full Merino Leather



ZBWT Canyon Brown Full Merino Leather

Equipment features and options.



Adaptive LED Headlights for both high and low beams project an intense white light that simulates daylight for excellent visibility. Convenient features that improve visibility include Automatic headlights, Adaptive turning, Cornering Lights, four Corona headlight-surrounds, and Automatic high beams. **Foglights** with LED technology improve visibility while adding a distinctive nighttime look.



Front signature kidney grille is framed in chrome. The slat fronts and sides in all 650i models are chrome; in the 640i models, the chrome slat fronts are set off by sides painted a contrasting black.



Xenon Adaptive Headlights optimize road illumination when entering a turn or corner, helping to enhance visibility when driving at night. Adaptive sensors continuously monitor the angle of the steering wheel to determine the direction in which your vehicle is heading. The outer headlights swivel accordingly, up to 15 degrees left or right.

Xenon low- and high-beam headlights illuminate the road ahead and to the side with brilliant clarity. An auto-leveling feature adjusts for varying passenger and cargo loads. **LED Corona headlight-rings** that frame the perimeter of both headlights and high beams also act separately as Daytime Running Lights and parking lights.



Taillight cluster with taillight, brakelights and turn-signal indicators incorporate LED technology for greater visibility. **Adaptive Brakelights** warn following vehicles by increasing in brightness when the intensity of your braking action is increased.



xDrive is an intelligent all-wheel-drive system that distributes drive power flexibly and variably to the front and rear axles for maximum traction, directional stability and driving safety in every road situation.



Power tilting glass panel roof on the BMW 6 Series Coupe gives the interior an even brighter, more spacious feel. It tilts up for greater ventilation, while a power sliding interior roofliner keeps the hot sun out.



6 Series Convertible softtop, with its streamlined, aerodynamic shape, gives the Convertible a coupe-like silhouette. Triple-lined, the middle layer helps reduce wind noise and enhances insulation all year round. In conjunction with the retractable rear window, it provides effective airflow. Available in Black, Beige and Moonlight Black.



Fully automatic roof operation. Feel the need for sky? At speeds up to 25 mph, simply press a button and in just 19 seconds this fully automatic softtop lowers and stores neatly in the trunk. It takes a mere 24 seconds to reverse the process. And, thanks to the Comfort Access feature, the softtop can also be opened via remote control.



Power glass rear window can be raised or lowered independently of the softtop. Raised with the softtop down, it minimizes road noise and breeze. When the top is up and the rear window is down, you enjoy enhanced ventilation throughout the cabin.



Convertible trunk with a compressible softtop storage box. The softtop takes up very little space when stored in its compartment behind the two rear seats. Even with the softtop down, the BMW 6 Series Convertible trunk can hold two golf bags. When the roof is up, the unused softtop storage compartment can be compressed, increasing available trunk space.

Equipment features and options.



Double Spoke (Style 351M) light alloy wheels. With **run-flat¹ performance tires^{2, 3}**: 19 x 8.5 front, 19 x 9.0 rear and 245/40 front, 275/35 rear tires. (Includes increased top-speed limiter.) With **run-flat¹ all-season tires²**: 19 x 8.5 wheels and 245/40 tires.



Double Spoke (Style 373M)
20 x 8.5 front, 20 x 9.0 rear light alloy wheels with 245/35 front and 275/30 rear **run-flat¹ performance tires^{2, 3}**.
(Includes increased top-speed limiter.)



Star Spoke (Style 365) 18 x 8.0 light alloy wheels with 245/45 **run-flat¹ all-season tires²**.



V Spoke (Style 366) light alloy wheels. With **run-flat¹ performance tires^{2, 3}**: 19 x 8.5 front, 19 x 9.0 rear and 245/40 front, 275/35 rear tires. (Includes increased top-speed limiter.) With **run-flat¹ all-season tires²**: 19 x 8.5 wheels and 245/40 tires.



Star Spoke (Style 367) 19 x 8.5 light alloy wheels with 245/40 **run-flat¹ all-season tires²**.



V Spoke (Style 356) 20 x 8.5 front, 20 x 9.0 rear light alloy wheels with 245/35 front and 275/30 rear **run-flat¹ performance tires^{2, 3}**. (Includes increased top-speed limiter.)

¹ Run-flat tires do not come equipped with a spare tire and wheel.
² Driving over rough or damaged road surfaces, as well as debris, curbs and other obstacles, can cause serious damage to wheels, tires and suspension parts. This is more likely to occur with low-profile tires, which provide less cushioning between the wheel and the road. Be careful to avoid road hazards and reduce your speed, especially if your vehicle is equipped with low-profile tires.
³ Performance tires are not recommended for driving in ice and snow conditions.

Wheel and tire specifications are subject to change. Get the latest information on BMW standard and optional features, packages and technical specifications. Visit bmwusa.com, select the BMW model of your choice, and click on "Features & Specs."



Three-spoke leather-wrapped multi-function sport steering wheel, featuring power tilt/telescoping adjustments, lets you keep both hands on the steering wheel while adjusting the audio, as well as your BMW-tested, Bluetooth[®] enabled mobile phone.* The left-hand buttons operate all Cruise Control functions, while those on the right control audio functions, such as the radio, your mobile phone and Voice command.

*Check for a list of tested mobile phones at your authorized BMW center or bmwusa.com/bluetooth.



8-speed Sport Automatic transmission with Adaptive Transmission Control (ADT) provides extremely fast synchronized shifting in either the Sport or Manual shift mode. Includes racing-inspired steering wheel-mounted paddle shifters.



Instrument cluster displays speedometer, tachometer, fuel gauge and engine oil temperature. Below the four dials is a high-resolution Info Display that shows data such as current fuel consumption, range, on-board computer functions, mileage and trip information.

Black Panel Display technology shows the instrument cluster as a matte black surface when the ignition is switched off, with only the chrome rings of the circular instruments visible in 3-D. When the ignition is switched on, the chrome rings turn into full circles, and the dials and displays appear. Turning on the ignition also activates the Check Control messages.



Contrast stitching adds a custom look to the interior. Two distinctive flat-felled seams – the same color as the Nappa Leather upholstery – run along the instrument panel. Black Nappa Leather upholstery features Gray contrast stitching.



Heated steering wheel is a feature that, like heated seats, becomes a "must-have" once it's experienced. The heating switch is conveniently located on the multi-function steering wheel.



Driving Dynamics Control adjusts driving characteristics by pressing a button to select one of five settings. Choose COMFORT, COMFORT+, SPORT, SPORT+ or ECO PRO mode to adjust the engine-throttle response, shift characteristics and power-steering assist. Another button disengages the traction control feature when driving on sand, gravel, or deep or packed snow.



Ceramic controls present a deep black glazed finish to various controls, such as the iDrive Controller bezel, front and rear ventilation controls, and audio controls. The black ceramic provides a rich, custom look and unusually unique feel to the interior.

Equipment features and options.



Ambiance lighting adds the drama of a warm reddish light that runs from front to rear beneath the inner door ledge. Ambiance lighting also includes soft on/off interior lights; reading lights; vanity mirror lighting; illumination in the front footwells, trunk, and storage compartments in the center console and doors; and illuminated door trims and sills with metal insets.



Comfort Access unlocks and lets you start the vehicle simply by carrying the remote fob in a pocket or purse. In the Convertible, this feature also lets you raise and lower the roof remotely. Vicinity lights are included in the door handles.

Soft-close automatic feature gently closes the doors.



Tailpipes. The BMW 640i and 640i xDrive Coupe and Convertible have two round tailpipes on the right and left with chrome surrounds.



Tailpipes. The BMW 650i and 650i xDrive Coupe and Convertible display two rhombus-shape tailpipes covered with a chrome frame.



Black Nappa Leather with contrast stitching covers the instrument panel, upper door, side trims and center console, extending the rich look and feel of the interior. The contrast stitching matches the Nappa Leather seat upholstery color; Black Nappa Leather seats come with Gray contrast stitching.

Leather upholstery; Leather on all seating surfaces; other components may be Leather or SensaTec.

Get the latest information on BMW standard and optional features, packages and technical specifications. Visit bmwusa.com, select the BMW model of your choice, and click on "Features & Specs."



Control Display shows the functions supported by the iDrive Controller, vehicle settings and radio, as well as the Navigation system. The free-standing, high-resolution flatscreen 10.2-inch color monitor is glare-free, and positioned at an ideal viewing height and distance.

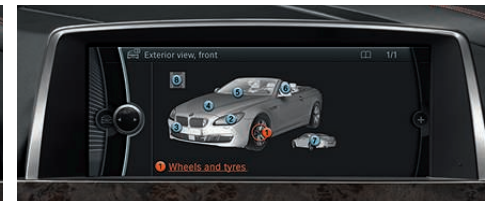

Integrated Owner's Manual provides immediate access to all vehicle-specific information. This digital version of the traditional printed manual that is included with your BMW can be accessed via the iDrive and is shown on the Control Display. The system's user-friendly features include multi-media elements, such as animations and dynamic illustrations.



BMW Night Vision with Pedestrian Detection can scan up to 900 feet ahead using an infrared camera in the front bumper.¹ It can detect people and animals, as well as the direction of their movement, up to approximately 300 feet away, and displays their presence on the iDrive screen and Head-up Display (if so equipped). The system gives a visual warning as soon as pedestrians or animals move toward the road, alerting you to potential dangers significantly earlier, so you can react more quickly.

¹ Under optimal road conditions. Night Vision performance is also limited by rain, fog, humidity and other weather conditions.



Active Blind Spot Detection warns you if a vehicle is in your blind spot, or if a vehicle is approaching at high speed in the passing lane, by displaying a visual signal in the exterior mirror casing. The system also warns you by making the steering wheel vibrate should you then use the turn-signal indicator before executing a lane change.



Rear-view Camera shows, on the Control Display, the area behind your vehicle. Working with Park Distance Control, interactive guidelines indicate if a parking space can accommodate your vehicle, and display parking trajectories and turn angles. Located behind the BMW badge on the trunk lid, the feature is activated by engaging either the reverse gear or the iDrive system.

Park Distance Control (PDC) sounds a warning beep as your front or rear bumper approaches an object, turning into a constant tone when the item is less than 12 inches away. Distance to the item is also shown in the Control Display.



Parking Assistant searches for suitable parking spots and then steers your vehicle into them. Press the "Park Assistant" button, then drive along potential parking spaces on the left or right side of the road, staying below 22 mph and no more than five feet away. Using ultrasonic sensors integrated into the side indicators, the system searches for and measures parking spaces. When a space at least four feet longer than your vehicle is spotted, it is shown on your Control Display. Shift into reverse and Parking Assistant takes control of steering your vehicle into the selected space; you operate the accelerator and brake pedals. Acoustic and visual warnings of Park Distance Control (PDC) provide assistance.

Equipment features and options.



Front armrest with integrated storage compartment opens up to allow access to the Enhanced USB Adapter, and installation of the Snap-in Adapter accessory for your smartphone.



Premium anti-theft AM/FM stereo CD/MP3 audio system with Radio Data System (RDS), Auto-Store, and 3-channel FM diversity antenna. The Coupe's 16 speakers and the Convertible's 12 speakers feature Dirac signal processing and surround mode, and discrete 5.1 multi-channel sound. The 7-band equalizer incorporates an analog amplifier with vehicle-specific equalizing; it outputs 600 watts in the Coupe and 500 watts in the Convertible.



2-zone automatic climate control allows driver and front passenger to select individual temperatures and choice of fan speeds, as well as choose automatic or manual airflow and recirculation. The automatic recirculation control activates whenever certain air pollutants are detected. The system also offers a mist-up sensor, solar sensor and residual heat use.



Heated front seats are a welcome feature for driver and front passenger in cooler weather. By pressing the icon button, seat surface and backrest are heated and quickly radiate comfortable warmth in your choice of settings.



20-way power Multi-contour front seats conform to your body to provide optimum support and exceptional comfort over long distances. In addition to horizontal, vertical and angled adjustments, Multi-contour seats include an articulated upper backrest, comfort headrest (two-way power, two-way manual "relax headrest"), and four-way power-adjustable lumbar support. Both driver's and front-passenger's seats include memory function.

Active front seats (not shown) imperceptibly raise and lower the left and right halves of the seating surface. This movement keeps the spine in motion, exercising various support muscles to help reduce fatigue on longer trips.

Ventilated front seats (not shown) gently blow warm or cool air through the micro-perforations in the leather to keep driver and front passenger comfortably dry in hot weather, and warm in colder weather.



10-way power driver's and front passenger's seats with horizontal, vertical and angled adjustments. **Lumbar support** adds four-way power-adjustable support for the lower back. **Memory function** retains settings for driver and front passenger seats, steering wheel and outside mirrors.



Integrated safety-belt system provides optimal protection and ergonomic comfort for the driver and front-seat passenger. The seat-integrated design also helps make entering and exiting the rear cabin easier.



Rear seating consists of two individual leather-covered seats. Both include an ergonomic belt system with integrated belt catches, two three-point safety belts and headrests. A LATCH child-seat fastening system is also included.



SiriusXM® Satellite Radio delivers over 140 channels of the most innovative satellite radio music, news, sports, talk, comedy and entertainment. All music channels are commercial-free, delivered coast-to-coast in crystal-clear digital sound, 24 hours a day. Sign up for the Sirius Premier package and you can enjoy even more programming, including every MLB® game, Oprah Radio® NHL® and NBA games, Opie & Anthony, Bob Edwards and more.

Get the latest information on BMW standard and optional features, packages and technical specifications. Visit bmwusa.com, select the BMW model of your choice, and click on "Features & Specs."

Leather upholstery: Leather on all seating surfaces; other components may be Leather or SensaTec.

Equipment features and options.



Door sills include metal insets finished in high-gloss chrome with a fine-brushed aluminum surround for durability. When the doors are opened, the BMW logo and adjacent strips in each door sill illuminate – a practical and elegant design feature.



Comfort entry to the rear seats is facilitated by enabling the seatbacks to be released easily with one hand to move the seat back and seat base forward.



Ski bag accommodates up to two pairs of skis or other long objects for practical transport inside the vehicle even when rear seats are occupied. The bag protects transported items as well as the vehicle interior from damage, and can be tucked away out of sight in the backrest when not in use.



Power rear sunshade can be extended with the touch of a button to protect the Coupe's cabin from the sun's rays in warm weather, or retracted to allow the sun to help warm the interior in colder weather.

Original BMW Accessories.



On the BMW 6 Series Coupe: V Spoke (Style 356) 20-inch bicolor cast alloy wheels; carbon-fiber exterior mirror caps.



Snap-in Adapter with USB interface plays stored music through your vehicle's speakers, charges the phone, and accesses the vehicle's antenna for better reception.



Multi-functional trunk mat with collapsible box helps organize cargo and keeps your trunk protected, clean and looking new.



Carbon-fiber exterior mirror caps are perfectly designed for the lines of the BMW 6 Series.

Driving a BMW is always a special experience, which can be enhanced even further with Original BMW Accessories. Benefit from innovative solutions combining unique ideas, stunning design and supreme functionality. Discover the wide range of Original BMW Accessories available to you, enhancing such aspects as the interior and exterior, technology, transporters and protection. For additional information, please visit your authorized BMW center or visit shopbmwusa.com.

Get the latest information on BMW standard and optional features, packages and technical specifications. Visit bmwusa.com, select the BMW model of your choice, and click on "Features & Specs."

BUILD YOUR OWN BMW – AT BMWUSA.COM/BYO.



At BMW, we want you to create your own Ultimate Driving Machine®. That's why BMW offers one of the widest model ranges of any luxury automotive manufacturer. And each BMW model offers its own universe of personalizing possibilities.

It's easy to get the latest information on your favorite BMW model, whether you're at your desk or on the go. Visit bmwusa.com on your computer, tablet or smartphone, and click on the BMW model of your choice. Select "Features & Specs" to see all the standard features and available options and packages, as well as technical specifications.

You can then create the exact BMW model that fulfills your needs by clicking on "Build Your Own" – or visiting bmwusa.com/byo. Here you'll be able to select from among the many interior and exterior colors and trims, personalizing options and value-added packages. Build a BMW model that reflects your style, then view it in 360° detail. At the press of a button, see payment and financing options, get a same-day quote, download a product brochure and even schedule a test drive. BMW makes it easier than ever to make your ultimate driving dreams come true, at bmwusa.com.

BMW 6 Series Coupe

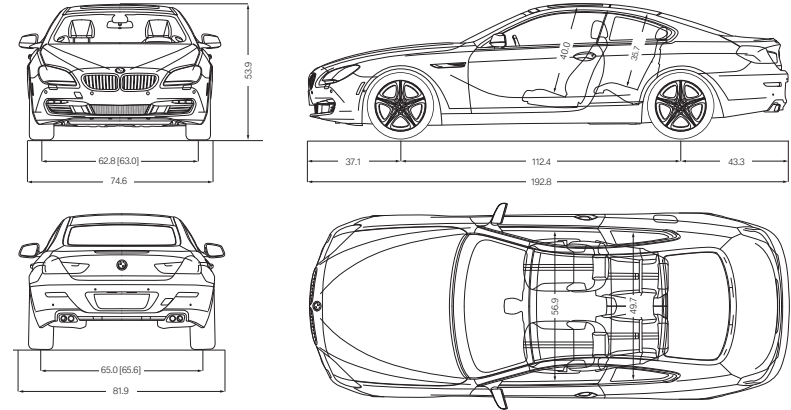

BMW 6 Series Convertible

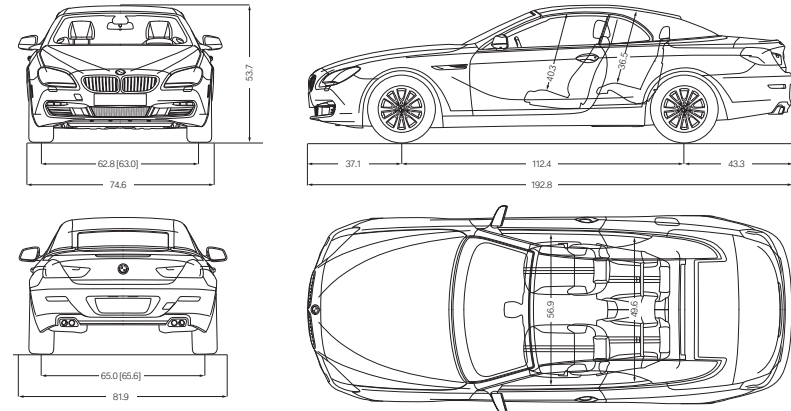

All dimensions in the technical drawings are given in inches. Dimensions shown apply to 650i and 650i xDrive; additional dimensions shown in [] apply to 640i and 640i xDrive.

Weight		640i Coupe	640i xDrive Coupe	650i Coupe	650i xDrive Coupe
Unladen weight					
Manual transmission	lbs	—	—	4410	—
Automatic transmission	lbs	4001	4190	4275	4275
Weight distribution, front/rear					
Manual transmission	%	—	—	52.9/47.1	—
Automatic transmission	%	51.2/48.8	53.8/46.2	52.9/47.1	53.7/46.3

Engines		TwinPower Turbo Inline 6/4	TwinPower Turbo Inline 6/4	TwinPower Turbo V-8/4	TwinPower Turbo V-8/4
Type/valves per cylinders					
Displacement	cu cm	2979	2979	4395	4395
Bore/Stroke	inch	3.30/3.50	3.30/3.50	3.50/3.50	3.50/3.50
Nominal output @ rpm	hp	315@5800–6000	315@5800–6000	445@5500–6000	445@5500–6000
Maximum torque @ rpm	lb-ft	330 @ 1400–4500	330 @ 1400–4500	480 @ 2000–4500	480 @ 2000–4500
Compression ratio	-:1	10.2	10.2	10.0	10.0

Transmission		I/III/III -:1	4.71/3.14/2.11	4.71/3.14/2.11	4.71/3.14/2.11	4.71/3.14/2.11
Automatic gear ratios						
		IV/V/VI -:1	1.67/1.29/1.00	1.67/1.29/1.00	1.67/1.29/1.00	1.67/1.29/1.00
		VII/VIII -:1	0.84/0.67	0.84/0.67	0.84/0.67	0.84/0.67
Reverse gear ratio	-:1	3.30	3.30	3.32	3.32	
Final drive ratio	-:1	3.23	3.23	2.81	2.81	

Performance					
Top speed ¹	mph	130 [155]	130	155	155
Acceleration 0–60 mph ²	sec	5.3	5.5	4.5	4.3

Fuel consumption ³					
Automatic transmission – City/highway	mpg	22/32	20/29	17/25	16/24
Fuel tank capacity, approx.	gal	18.5	18.5	18.5	18.5

¹ Top speed limited electronically.² BMW AG test results; preliminary test results for 650i and 650i xDrive models. Actual acceleration results may vary, depending on specification of vehicle, road and environmental conditions; testing procedures and driving style. These results should be used for comparison only and verification should not be attempted on public roads. BMW urges you to obey all posted speed laws and always wear safety belts.³ EPA-estimated figures are for comparison purposes only. Your actual mileage will vary, depending on speed, driving habits, trip length and driving conditions; actual mileage may be lower.For latest available information please visit bmwusa.com.

Figures in [] apply to vehicles with performance tires and increased top-speed limiter.

Weight		640i Convertible	640i xDrive Convertible	650i Convertible	650i xDrive Convertible
Unladen weight					
Manual transmission	lbs	—	—	4520	—
Automatic transmission	lbs	4586	4455	4520	4650
Weight distribution, front/rear					
Manual transmission	%	—	—	50.8/49.2	—
Automatic transmission	%	49.2/50.8	52.2/47.8	50.8/49.2	52.2/47.8

Engines		TwinPower Turbo Inline 6/4	TwinPower Turbo Inline 6/4	TwinPower Turbo V-8/4	TwinPower Turbo V-8/4
Type/valves per cylinders					
Displacement	cu cm	2979	2979	4395	4395
Bore/Stroke	inch	3.30/3.50	3.30/3.50	3.50/3.50	3.50/3.50
Nominal output @ rpm	hp	315@5800–6000	315@5800–6000	445@5500–6000	445@5500–6000
Maximum torque @ rpm	lb-ft	330 @ 1400–4500	330 @ 1400–4500	480 @ 2000–4500	480 @ 2000–4500
Compression ratio	-:1	10.2	10.2	10.0	10.0

Transmission		I/III/III -:1	4.71/3.14/2.11	4.71/3.14/2.11	4.71/3.14/2.11	4.71/3.14/2.11
Automatic gear ratios						
		IV/V/VI -:1	1.67/1.29/1.00	1.67/1.29/1.00	1.67/1.29/1.00	1.67/1.29/1.00
		VII/VIII -:1	0.84/0.67	0.84/0.67	0.84/0.67	0.84/0.67
Reverse gear ratio	-:1	3.30	3.30	3.32	3.32	
Final drive ratio	-:1	3.23	3.23	2.81	2.81	

Performance					
Top speed ¹	mph	130 [155]	130	155	155
Acceleration 0–60 mph ²	sec	5.4	5.3	4.5	4.4

Fuel consumption ³					
Automatic transmission – City/highway	mpg	20/30	20/29	17/25	16/24
Fuel tank capacity, approx.	gal	18.5	18.5	18.5	18.5

U.S. Importer: BMW of North America, LLC, Woodcliff Lake, NJ 07677. All illustrations and specifications contained in this brochure are based on the latest product information available at the time of printing. BMW reserves the right to make changes at any time, without notice, in colors, materials, equipment, specifications and models. BMW may, subject to legal requirements, determine the Model Year designation of its vehicles. The Model Year designation on any particular model may be longer or shorter than 12 months. Some vehicles pictured may contain non-U.S. equipment. Some models may be shown with optional equipment. While BMW NA makes all reasonable efforts to provide accurate information in this brochure, there is no guarantee or warranty of accuracy. Furthermore, we do not assume any liability for the accuracy or completeness of information presented. This brochure shall not be used or relied upon as a substitute for information that is available from your authorized BMW center. Further information can be obtained from your authorized BMW center or bmwusa.com.

©2013 BMW of North America, LLC. Not to be reproduced wholly or in part without written permission of BMW NA. The BMW name, logo, model names and SAV are registered trademarks. The Bluetooth word mark and logos are owned by the Bluetooth SIG, Inc. and any use of such marks by BMW is under license. iPhone and iPod are registered trademarks of Apple Inc. Other trademarks and trade names are the property of their respective owners.

We believe that a premium ownership experience should feature performance and luxury, as well as safety and convenience. We believe you should be able to drive a BMW to its potential, while enjoying peace of mind and reduced cost of ownership. That's the idea behind **BMW Ultimate Service**[®]: a suite of comprehensive programs and services that are included in every new BMW vehicle. It starts with the **New Vehicle/SAV Limited Warranty**,¹ providing you

with coverage for the first four years or 50,000 miles, whichever comes first. Additionally, you enjoy 12-year, unlimited-mileage warranty protection against corrosion and rust perforation.¹ BMW Ultimate Service continues with **BMW Maintenance Program** for up to the first four years or 50,000 miles,² **BMW Roadside Assistance**, and more.

GOING BEYOND ENGINEERING: THE HIGH-PERFORMANCE BMW OWNERSHIP EXPERIENCE.



BMW Maintenance Program

is one of the most comprehensive maintenance programs in its class. We cover all factory-recommended maintenance for up to the first four years or 50,000 miles, whichever comes first. This includes scheduled oil services and inspections. Also covered is the replacement of items that are subject to normal wear and tear, such as brake pads, wiper blade inserts and engine drive belts.² And, thanks to BMW's advanced engineering, most owners enjoy a well-balanced maintenance schedule, with flexible routine service intervals that can save you time. When your vehicle requires attention, your authorized BMW center ensures that it receives only genuine BMW parts – your assurance of exacting quality standards.

For more details on BMW Ultimate Service and the BMW Maintenance Program, visit your authorized BMW center or log on to bmwusa.com/ultimateservice.



BMW Assist eCall

³ a safety feature of BMW ConnectedDrive, lets you enjoy peace of mind knowing that a friendly response specialist is there to help you, 24/7, at just the push of a button. This includes Emergency Request (SOS button), Automatic Collision Notification, and Customer Relations. **BMW TeleService**³ continually monitors specific vehicle parts that are subject to wear and tear, as well as services that require attention at regular intervals, such as vehicle service inspections. This data is automatically transmitted to your authorized BMW center, which informs a BMW Service Advisor to call and schedule a convenient service appointment. You don't have to keep track of when your vehicle requires routine maintenance. An added benefit: any needed maintenance service parts will already be on hand, so your BMW is serviced and returned to you as quickly as possible. And because they use only Original BMW Parts, you can rely on expert fit and long-lasting BMW quality.



BMW Roadside Assistance is provided free of charge for the first four years – with no mileage limit. Call **1-800-332-4BMW (4269)** for friendly on-the-road help, 24/7, anywhere in the United States, Canada and Puerto Rico. This includes everything from flat-tire changes, emergency gasoline and lock-out service, to towing, alternative transportation and even trip-interruption benefits. This service also provides valuable trip-routing advice.

BMW Online⁴ provides up-to-date web information: business and stock reports, as well as weather updates. BMW Online also includes **MyInfo**, which allows you to send business locations and street addresses with their associated phone numbers from the Google Maps™ website directly to your BMW. The destination can be sent to your Navigation system for turn-by-turn directions.

Enhanced USB and Bluetooth[®] with Smartphone Integration offers an array of Mobile Office⁶ functions. With the BMW Navigation system and your mobile phone linked via Bluetooth technology, Mobile

Office transfers text messages and emails to your iDrive Display screen and then reads them aloud to you. While en route, a calendar and to-do list can also appear on your Display screen. Running late? Click on the phone number in the calendar to call your appointment. For a list of tested mobile phones, visit bmwusa.com/bluetooth.

Remote Services³ includes Remote Door Unlock, Stolen Vehicle Recovery, and access to the My BMW Remote app, which allows you to control your BMW from your mobile device.

For the ultimate in coverage, add the optional **Concierge Services**.⁵ You'll enjoy unlimited access to personalized Directions and services for restaurant and hotel recommendations, with the destination address and phone number not only sent right to your BMW, but also transferred to your Navigation system for route guidance. Another useful Concierge feature: **Critical Calling**. This lets you make up to four operator-assisted calls per year, up to five minutes per call, if your mobile phone is not available, or if its battery is discharged.



EXPERIENCE MORE WITH BMW.



BMW Financial Services. Arranging to buy or lease a BMW is easier than you may think. Your authorized BMW center offers leasing and financing to suit your personal needs through BMW Financial Services.⁷ Start the process at our website, where you can build your “dream vehicle,” get an estimate on a monthly lease or financing payment, submit a credit application to BMW Financial Services – and get approval – all online!⁷ To find out how BMW Financial Services can help put you behind the wheel of your favorite BMW model, log on to bmwusa.com/fs or call, toll-free, **1-800-578-5000**.



BMW Virtual Center. If you get the sudden urge to shop for a BMW but your authorized BMW center is closed, there's good news – the BMW Virtual Center is open 24 hours a day! Log on to bmwusa.com/byo, and choose the model that interests you. Configure the BMW of your dreams and see what the monthly payments would be. You can even send the specifications to your authorized BMW center, apply for financing or request a test drive – all online!



BMW Magazine. A fascinating view of the latest events and products in the world of BMW, including travel reviews, personality profiles and the latest BMW technologies. **BMW Magazine** is sent to new owners and lessees twice a year



BMW Performance Driving School. Take your driving skills to the next level. Behind the wheel of new BMWs and under the guidance of professional instructors, you'll hone your driving skills on a 1.7-mile driving course that can be configured in a multitude of ways. In One- and Two-Day Schools you can tackle the skid pad, slalom course and water walls. The BMW Performance Driving School is about control and pushing a BMW to its limits – and yours. Visit bmwusa.com/pds.

Performance Center Delivery. You'll always remember the fun of taking delivery of your new BMW – especially with BMW Performance Center Delivery in Spartanburg, SC. After enjoying dinner and an overnight stay at a first-class hotel, we'll take you and your companion to the Performance Center where a Product Specialist will give you an in-depth introduction to your new BMW. Then at the Performance Driving School, you'll get tips from a professional driving instructor as you explore the dynamic capabilities of a similar model. It's exciting, it's enlightening – and it's all compliments of BMW with your new vehicle. To learn

more about the BMW Performance Center, call **1-888-345-4269** or visit bmwusa.com/pdsdelivery.



The **BMW Welt** (“BMW World”) delivery and brand-experience center in Munich is bold proof of BMW's passion for design. When you take advantage of the BMW European Delivery Program,⁸ this is where you will meet your new BMW – in a personalized process that is highly dramatic and totally unforgettable. (You might also realize substantial savings that just may pay for your trip.) While you're there, marvel at the historic BMWs in the Museum; learn about our engineers' newest innovations in the Technology and Design Atelier; and take a tour of the plant to experience firsthand the state-of-the-art methods used to create a BMW. Then comes the unique experience of driving your new BMW on the roads it was designed for. To learn more, visit bmwusa.com/europeandelivery.

ON-BOARD SERVICE ALERTS.

We monitor your BMW's needs – so you don't have to.

Tackling mountain switchbacks, the last thing you should be thinking about is the state of your brake pads. Thanks to BMW's integrated on-board diagnostics system, you'll always know exactly when the next service is due, and what work will be required. Condition Based Service (CBS) measures the condition of key parts that are subject to wear and tear. It also tracks fluid levels and monitors your BMW's time- and mileage-dependent service requirements. Using this data, the Info Display in the cockpit automatically alerts you in advance whenever any part of your vehicle will require servicing – so there are no surprises ahead.

¹ See your authorized BMW center for details on these limited warranties.

² All BMWs come with the BMW Maintenance Program standard for up to 4 years or 50,000 miles from the in-service date, whichever comes first. The BMW Maintenance Program covers factory-recommended maintenance services as determined by the Service Interval Indicator for all new eligible MY2004 and later BMW vehicles. Exclusions from coverage include: gasoline, gasoline additives, windshield washer fluid and additives, battery, tires, wheels, wheel alignment and tire balancing. All work must be performed by an authorized BMW center. For all Model Year 2015 and later vehicles sold or leased by an authorized BMW center on or after July 1, 2014: BMW Maintenance Program coverage is not transferable to subsequent purchasers, owners or lessees. Certain limitations and exclusions apply to this program; please see bmwusa.com/ultimateservice or ask your authorized BMW center for details.

³ On 2014 and later BMW iM5, BMW Assist eCall, BMW TeleService and Remote Services are standard and include 10 years of service. In order to receive these services, a subscriber agreement must be completed and transferred to the BMW Assist™ Response Center. GPS and underlying wireless services must be available and functioning, vehicle ignition must be turned on (except for Remote Services), battery must be charged and connected, and vehicle's electrical system operational. Due to wireless carrier coverage, services may be limited in certain geographic areas. Call toll-free **1-888-333-6118**, go to bmwassist.com, or visit your authorized BMW center for additional program details. Services are subject to the terms and conditions of your subscriber agreement.

⁴ BMW Online comes standard and includes a 3-year subscription. Subject to the terms and conditions of your subscriber agreement. Please go to bmwusa.com/connecteddrive for additional details.

⁵ Optional Concierge Services includes a 3-year subscription. Subject to the terms and conditions of your subscriber agreement. Visit bmwusa.com/connecteddrive for details.

⁶ Not all mobile phones are compatible with Mobile Office, and some compatible phones support a limited number of Mobile Office functions. For the complete list of compatible mobile phones and the details regarding which Mobile Office functions are supported by each phone, please visit bmwusa.com/bluetooth.

⁷ Subject to credit approval and other terms and conditions.

⁸ Not all models are available for BMW European Delivery Program. Please go to bmwusa.com/europeandelivery or visit your authorized BMW center for details.

More about BMW



bmwusa.com
1-800-334-4BMW

The Ultimate
Driving Machine®



BMW and the environment.

BMW is a strong proponent of the environment and social responsibility. We launched BMW EfficientDynamics back in 2000 – the philosophy of providing greater power with increased efficiency and fewer emissions. This has resulted in significant benefits today – for our customers, the climate and the environment.

That year, ecological sustainability was also declared one of BMW's core strategic principles; it is now firmly anchored in our entire production chain. It starts with the development of fuel-saving and alternative vehicle concepts, continues with environmentally friendly production processes, and ends with innovative recycling methods. This effort has been recognized worldwide; in 1999, BMW AG – the parent company of BMW of North America and BMW Manufacturing Co. in Spartanburg, SC – was the first automotive company to be represented on the Dow Jones Sustainability Group Index. It has remained on the Index ever since; moreover, since 2005, BMW has been voted the world's most sustainable automobile manufacturer. At BMW, we strive for and achieve high performance in all we do.

BMW recommends  **EDGE**

