A close-up, low-angle shot of a blue car's front end. The left headlight is illuminated, showing intricate LED patterns. The front wheel is visible on the right, featuring a multi-spoke alloy design. The car's body is highly reflective, showing highlights from the ambient light. The overall mood is sleek and sophisticated.

# PRODIGIOUS POWER, UNRIVALED LUXURY.

## ALPINA B7 AND B6.

With the power of a racecar and the sublime comfort of a luxury sedan, the ALPINA driving experience is exhilarating. Superior throttle response and high torque ensure smooth, instant acceleration. The brilliant engineering is matched only by pioneering design.

# ALPINA



# POWER, RAW AND PURE.

The third-generation, limited-production BMW ALPINA B6 is truly a rare breed: a seamless blend of superior design, dynamics innovation and luxury.



EXTERIOR COLORS

UPHOLSTERY

INTERIOR TRIMS

PACKAGES

WHEELS / TECHNICAL DATA



## READY FOR BLASTOFF.

Experience the handcrafted interior: blue ALPINA instrumentation, the ALPINA steering wheel in hand-stitched LAVALINA leather; the signature ALPINA production plaque overhead, ALPINA-emblem floormats, door-sill trims with illuminated blue ALPINA lettering, Nappa Leather upholstery with contrast stitching and more.

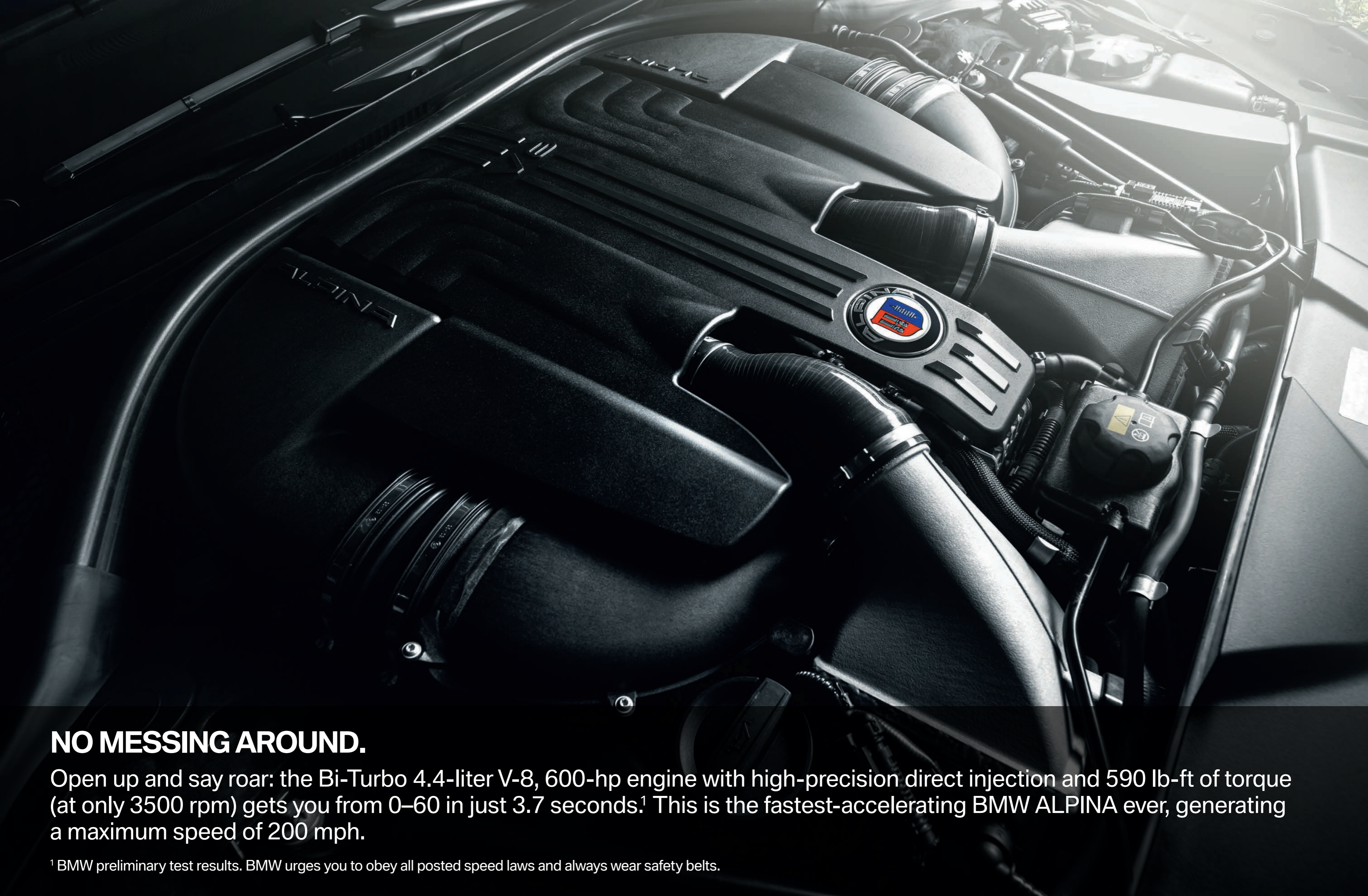

## **NO MESSING AROUND.**

Open up and say roar: the Bi-Turbo 4.4-liter V-8, 600-hp engine with high-precision direct injection and 590 lb-ft of torque (at only 3500 rpm) gets you from 0–60 in just 3.7 seconds.<sup>1</sup> This is the fastest-accelerating BMW ALPINA ever, generating a maximum speed of 200 mph.

<sup>1</sup> BMW preliminary test results. BMW urges you to obey all posted speed laws and always wear safety belts.



## BEAUTY IN MOTION.

The advanced ALPINA SWITCH-TRONIC 8-Speed Sport Automatic transmission excels in every mode, offering a smooth ride at any speed. The distinctive full stainless steel exhaust system features the trademark ALPINA elliptical quad tailpipes, striking a note that's deep and resonant, yet unobtrusive.



# BMW ALPINA B7 EXTERIOR COLORS

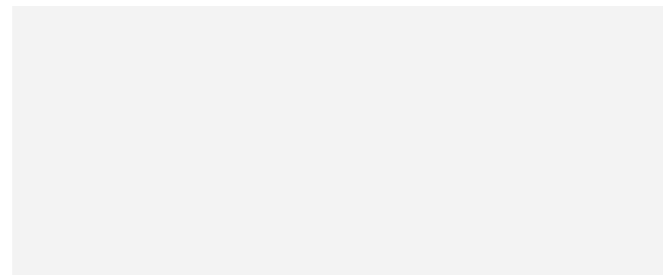

**300**  
Alpine White (Non-metallic)

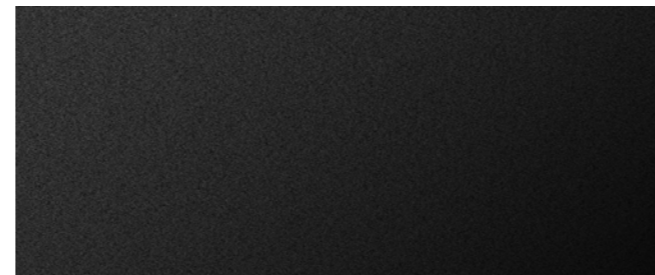

**475**  
Black Sapphire Metallic



**A83**  
Glacier Silver Metallic

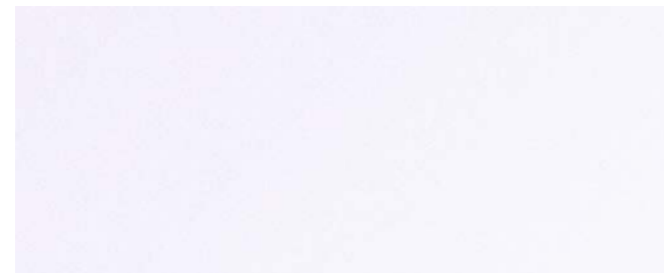

**A96**  
Mineral White Metallic

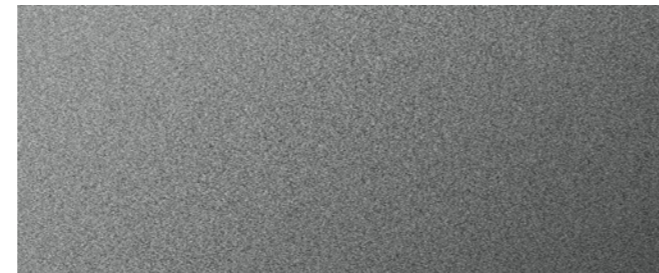

**C26**  
Magellan Gray Metallic



**X06**  
ALPINA Blue Metallic



**X09**  
ALPINA Green Metallic

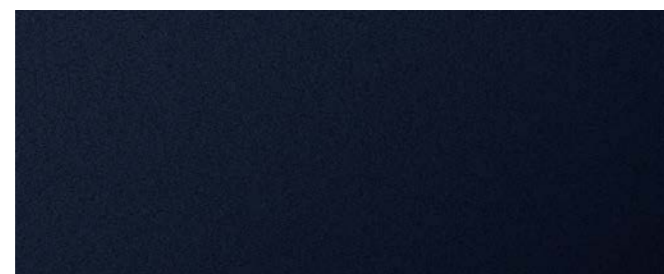

**S34**  
Azurite Black Metallic  
BMW Individual

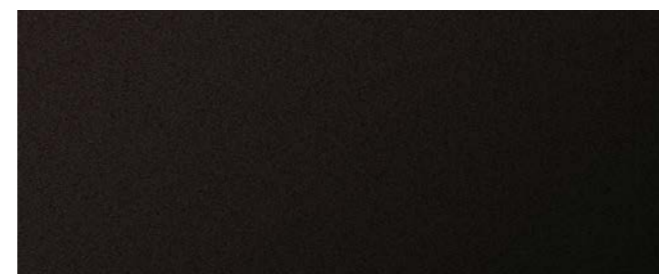

**X03**  
Ruby Black Metallic  
BMW Individual

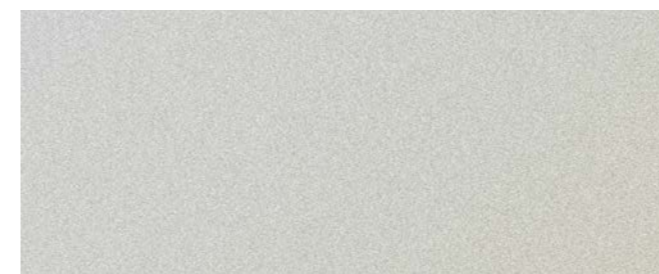

**X04**  
Moonstone Metallic  
BMW Individual

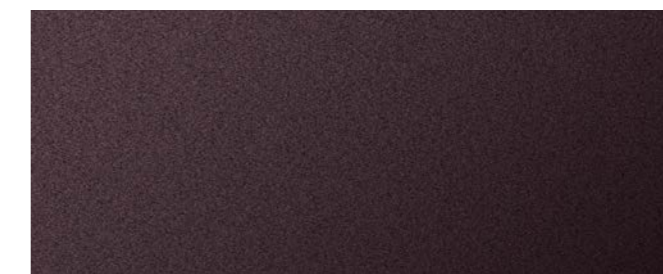

**X14**  
Almandine Brown Metallic  
BMW Individual



# BMW ALPINA B7 UPHOLSTERY

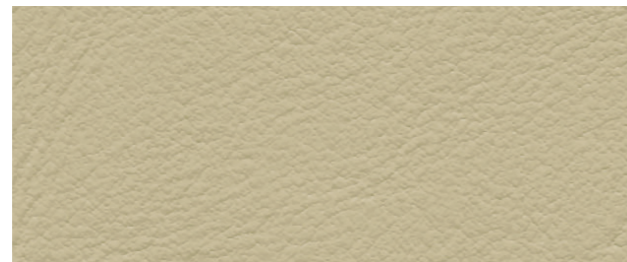

**NACY**  
Canberra Beige Nappa Leather

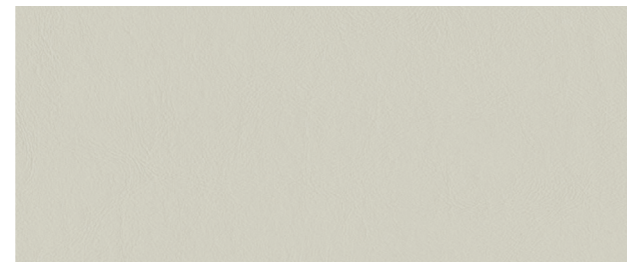

**NAEW**  
Ivory White / Black Nappa Leather

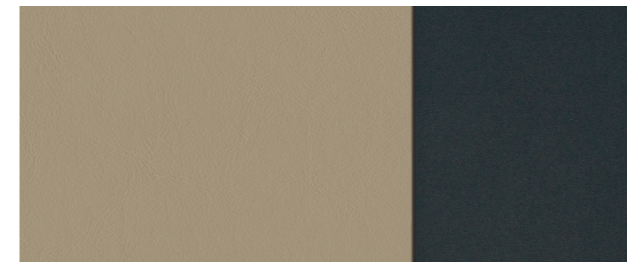

**NAFZ**  
Zagora Beige / Black Extended Nappa Leather

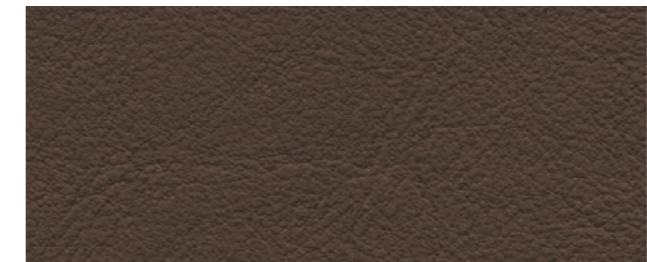

**NAMY**  
Mocha Extended Nappa Leather



**NARI**  
Cognac Extended Nappa Leather

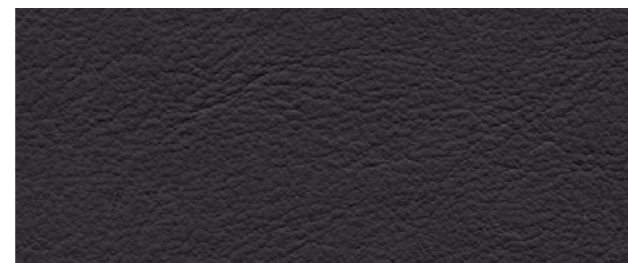

**NASW**  
Black Nappa Leather



**ZBCR**  
Caramel / Black Full Merino Leather  
BMW Individual

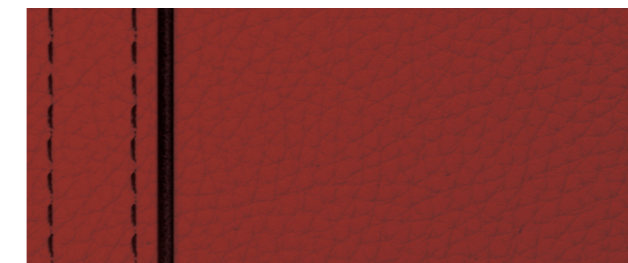

**ZBFQ**  
Fiona Red / Black Full Merino Leather  
BMW Individual



**ZBFU**  
Smoke White / Black Full Merino Leather  
BMW Individual



**ZBKS**  
Cashmere Beige / Black Full Merino  
Leather  
BMW Individual



**ZBRJ**  
Smoke White / Viola Full Merino  
Leather  
BMW Individual

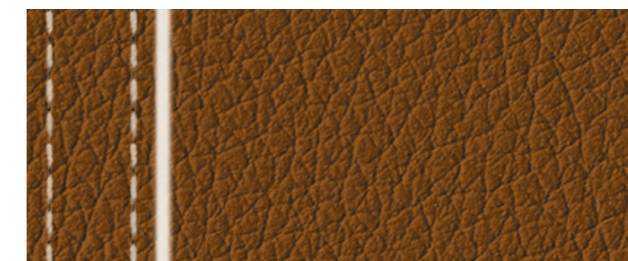

**ZBTQ**  
Tartufo Full Merino Leather  
BMW Individual



# BMW ALPINA B7 INTERIOR TRIMS



**XEY**  
ALPINA Myrtle Wood trim  
BMW Individual



**XEZ**  
ALPINA Piano Black trim  
BMW Individual



**4AS**  
Gray Poplar Wood trim



**4B9**  
Brushed Aluminum trim

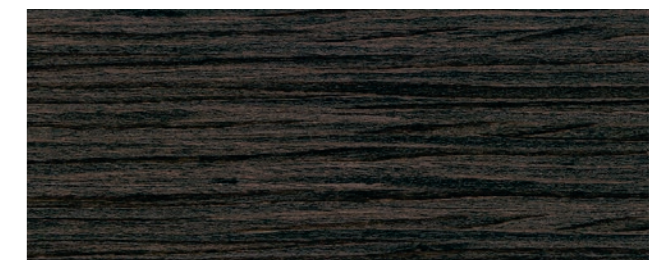

**4LM**  
Fineline Black Wood trim

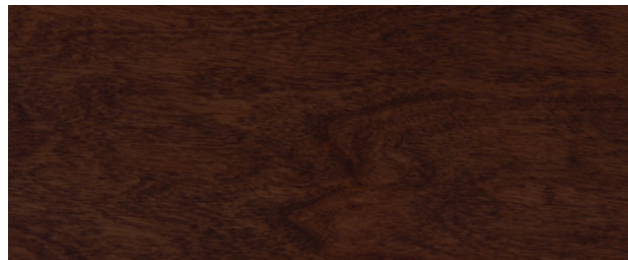

**4AX**  
Chestnut Wood trim  
with wooden inlay



**4AY**  
American Oak Wood trim  
with metal inlay

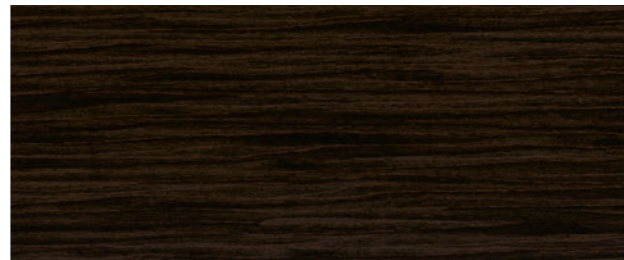

**4B7**  
Fineline High-Gloss Wood trim



**XE7**  
Piano Black trim

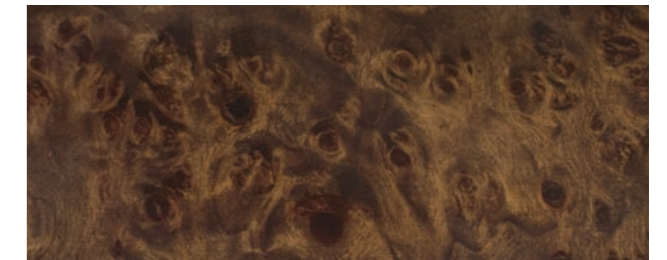

**4BP**  
Light Poplar Wood trim

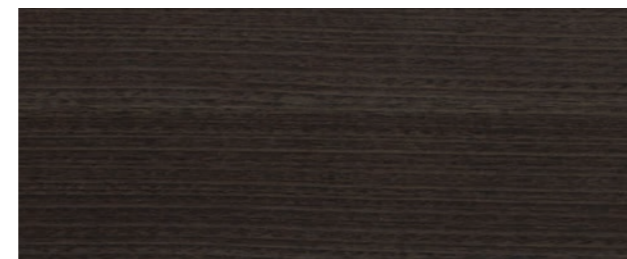

**XEA**  
Eucalyptus Smoke Brown Wood trim  
BMW Individual

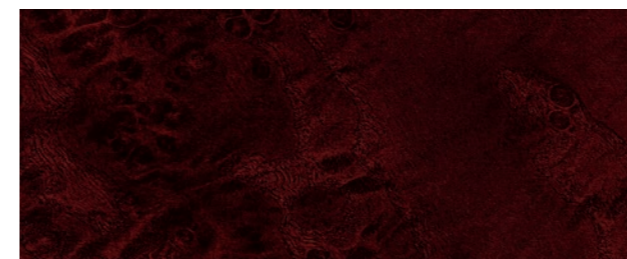

**XEB**  
Ash Grain Black and Red Wood trim  
BMW Individual





# BMW ALPINA B7 PACKAGES

## INTERIOR DESIGN PACKAGE

Ivory White Nappa Leather Upholstery  
Grab handle with wood trim  
Rear safety-belt cover and armrest with wood trim  
Rear luxury floormats  
Alcantara® headliner in upholstery color or Anthracite Alcantara headliner

## LUXURY REAR SEATING PACKAGE

Ventilated rear seats  
Rear Comfort seats  
Heated steering wheel  
Heated front and rear seats  
Heated front and rear armrests  
Massaging rear seats  
7" Touch Command tablet

## DRIVER ASSISTANCE PLUS II

Active Driving Assistant Plus  
Active Lane Keeping Assistant with side collision avoidance  
Traffic Jam Assistant

## DRIVER ASSISTANCE PLUS

Active Blind Spot Detection  
Active Driving Assistant<sup>1</sup>  
Lane Departure Warning  
Daytime Pedestrian Protection  
Frontal Collision Warning with City Collision Mitigation  
Side- and Top-view Cameras  
Speed Limit Info

## REAR EXECUTIVE LOUNGE SEATING PACKAGE

Electric reclining seat and footrest  
Executive Lounge rear center console  
Rear-seat Entertainment Professional with iDrive Control  
Executive Lounge seating

<sup>1</sup> Active Driving Assistant is not a substitute for the driver's own responsibility in maintaining safe control of the vehicle.

Get the latest information on standard and optional features, packages and technical specifications. Visit [bmwusa.com](http://bmwusa.com) and select the BMW model of your choice.



# BMW ALPINA B7 WHEELS & TECHNICAL DATA



**ALPINA CLASSIC light alloy wheels (Style B7)**  
 20 x 8.5 front, 20 x 10.0 rear; and 255/40 front, 295/35 rear performance<sup>1,2</sup> or all-season tires.<sup>1</sup> Also available as an option: 21 x 8.5 front, 21 x 10.0 rear; and 255/35 front, 295/30 rear performance<sup>1,2</sup> or all-season tires<sup>1</sup>

Wheel and tire specifications are subject to change. Get the latest information on the availability of standard and optional wheels and tires, packages and technical specifications. Visit [bmwusa.com](http://bmwusa.com) and select the BMW model of your choice.

<sup>1</sup>BMW ALPINA vehicles do not come equipped with a spare wheel and tire. Driving over rough or damaged road surfaces, as well as debris, curbs and other obstacles, can cause serious damage to wheels, tires and suspension parts. This is more likely to occur with low-profile tires, which provide less cushioning between the wheel and the road. Be careful to avoid road hazards and reduce your speed, especially if your vehicle is equipped with low-profile tires.

<sup>2</sup>Performance tires are not recommended for driving in snowy and icy conditions.

<sup>3</sup>BMW AG preliminary test results. Actual acceleration results may vary, depending on specification of vehicle, road and environmental conditions, testing procedures and driving style. These results should be used for comparison only, and verification should not be attempted on public roads. BMW urges you to obey all posted speed laws and always wear safety belts.

Get the latest information on the availability of standard and optional wheels and tires, packages and technical specifications. Visit [bmwusa.com](http://bmwusa.com) and select the BMW model of your choice.

ENGINE	4.4-liter ALPINA Bi-Turbo V-8
OUTPUT @ RPM	600 hp @ 5750–6250 / 590 lb-ft @ 3000–5000
0–60 MPH (sec) <sup>3</sup>	3.6
CITY / HIGHWAY MPG	16/24

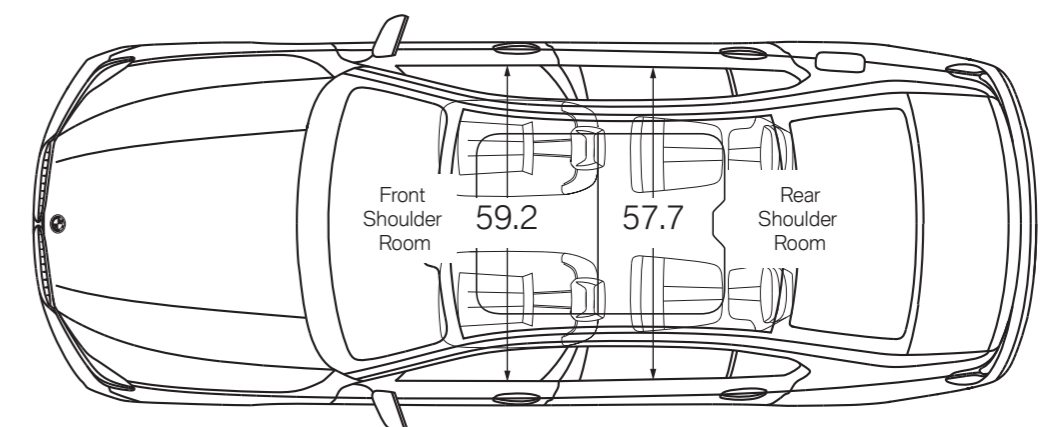
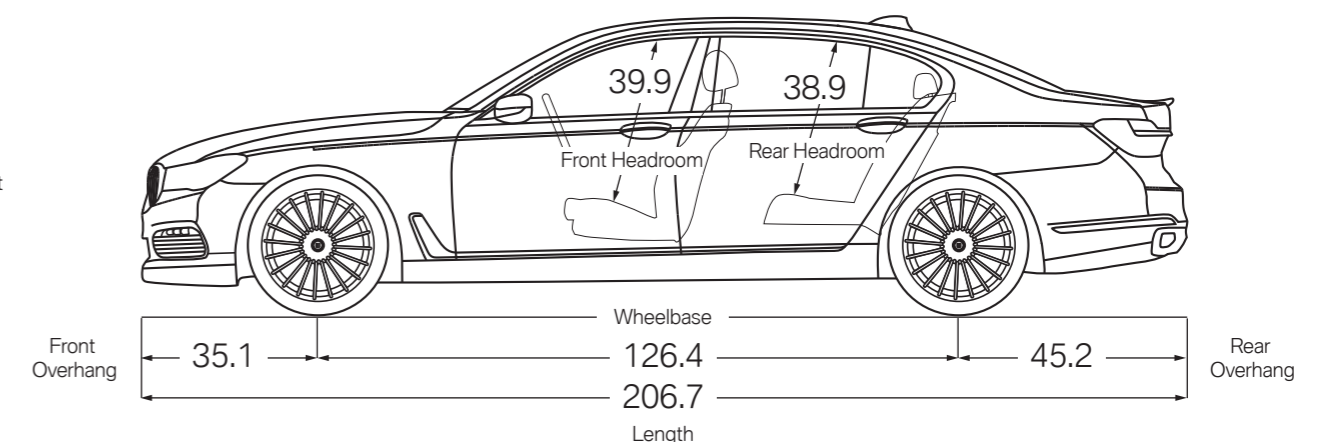
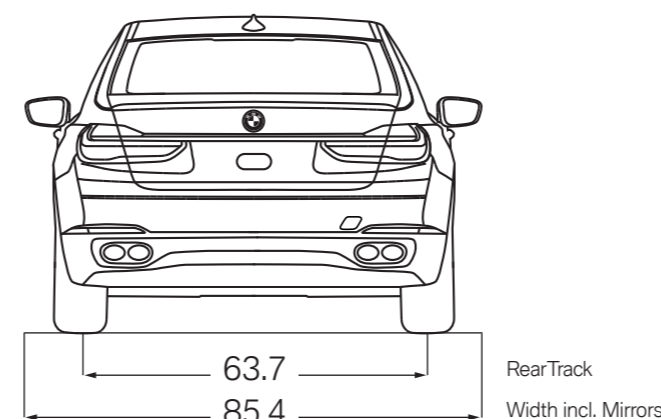
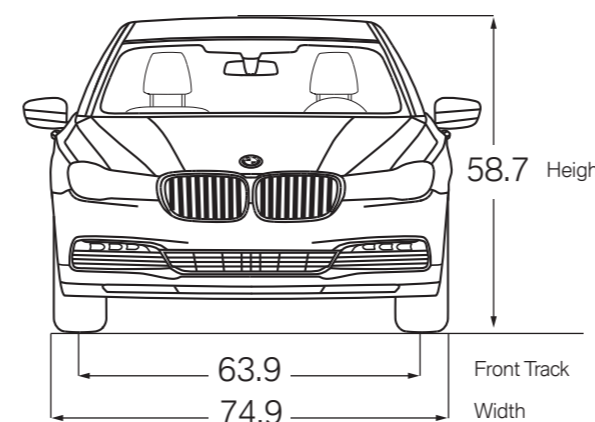

All dimensions in technical drawings are given in inches. Dimensions shown apply to Alpina B7.



## **INTERIOR MASTERPIECE.**

Inside the beautifully appointed cabin, you'll enjoy exclusive features, such as blue ALPINA instrumentation, the ALPINA steering wheel in hand-stitched LAVALINA leather, ALPINA luxury trims, a strikingly modern console and, of course, state-of-the-art BMW technology.



## **JAWS, PREPARE TO DROP.**

The potent beauty of the exterior is impressive enough, but there's nothing like the robust roar it emits when you start the engine.



## **AERODYNAMIC EXCELLENCE.**

No wonder it's the rarest prize on the road. From the aggressive front and rear spoilers, sweeping back to the elliptical twin tailpipes, a sleek, modern profile – with a racing-inspired Carbon Core frame and striking ALPINA design elements – reflect its astonishing performance. Iconic signature 20-spoke aluminum wheels add to the dynamic look.



# BMW ALPINA B6 EXTERIOR COLORS

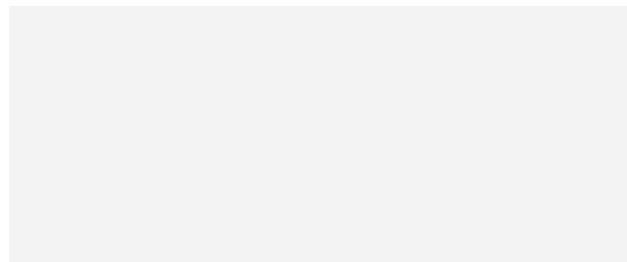

**300**  
Alpine White (Non-metallic)

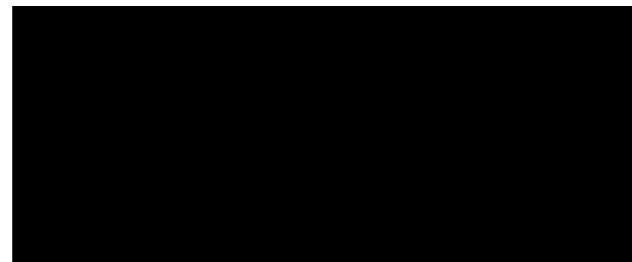

**668**  
Jet Black (Non-metallic)

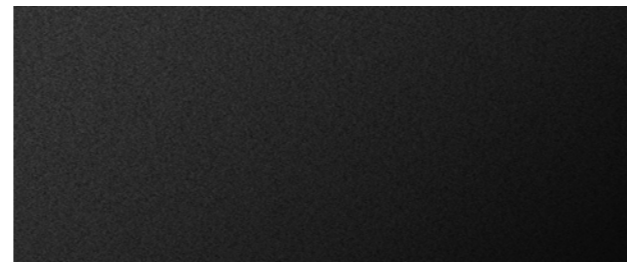

**475**  
Black Sapphire Metallic



**A52**  
Space Gray Metallic

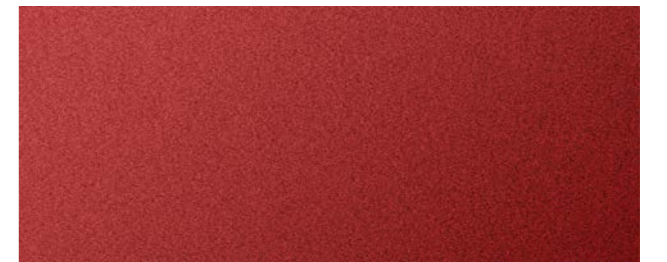

**A75**  
Melbourne Red Metallic



**A83**  
Glacier Silver Metallic



**A96**  
Mineral White Metallic

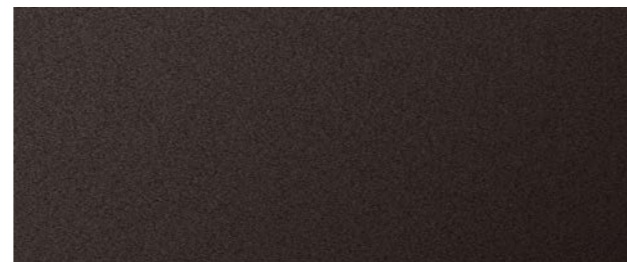

**B65**  
Jatoba Brown Metallic

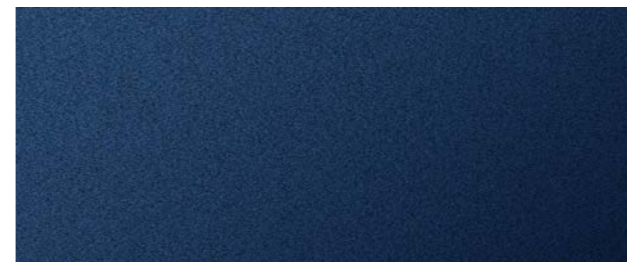

**C10**  
Mediterranean Blue Metallic



**X06**  
ALPINA Blue Metallic  
BMW Individual

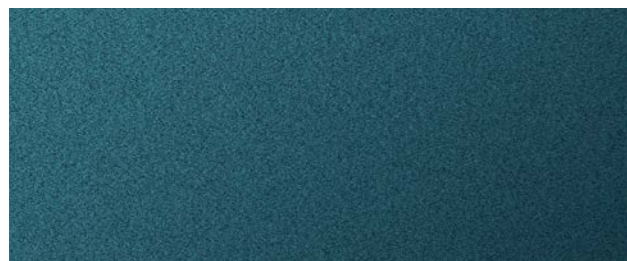

**X09**  
ALPINA Green Metallic  
BMW Individual

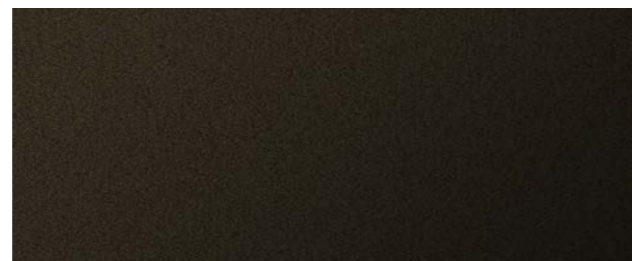

**X02**  
Citrin Black Metallic  
BMW Individual

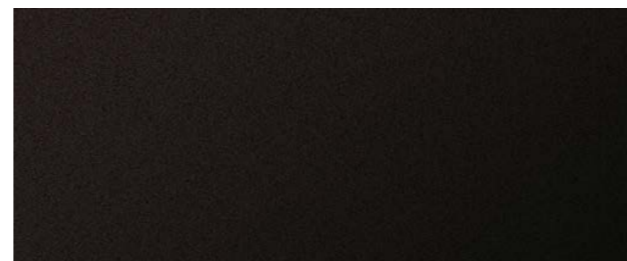

**X03**  
Ruby Black Metallic  
BMW Individual



**X04**  
Moonstone Metallic  
BMW Individual



**X10**  
Tanzanite Blue Metallic  
BMW Individual

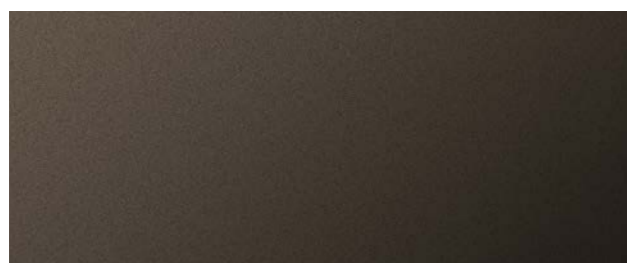

**X11**  
Frozen Bronze Metallic  
BMW Individual

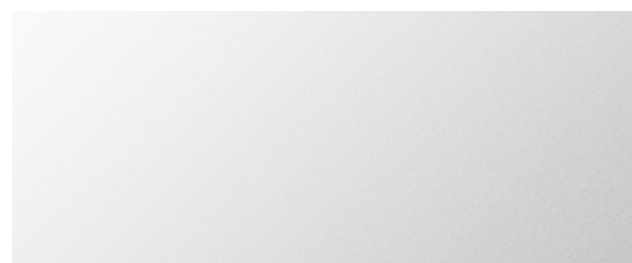

**X16**  
Frozen Brilliant White Metallic  
BMW Individual



# BMW ALPINA B6 UPHOLSTERY

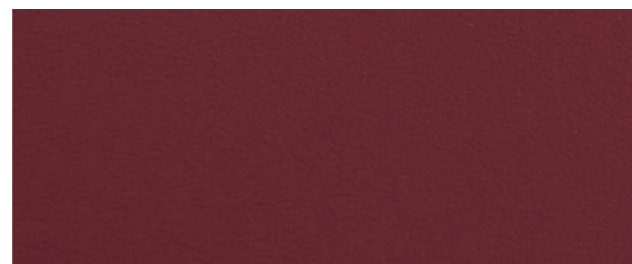

**NABY**  
Vermilion Red Nappa Leather

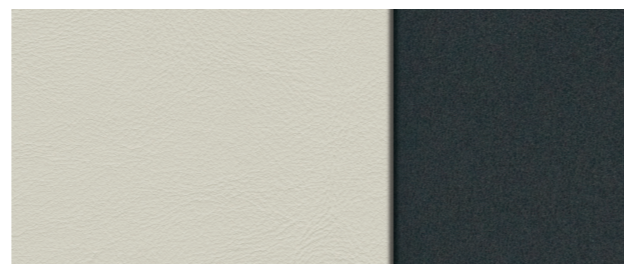

**NAEP**  
Ivory White / Black Extended  
Nappa Leather

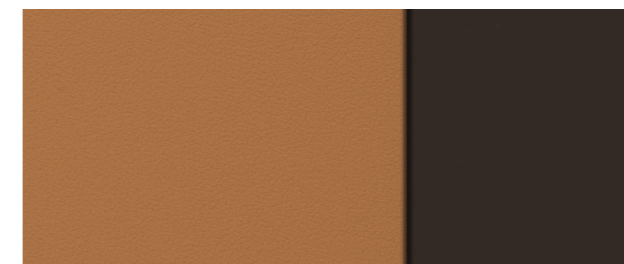

**NARQ**  
Cognac / Black Nappa Leather

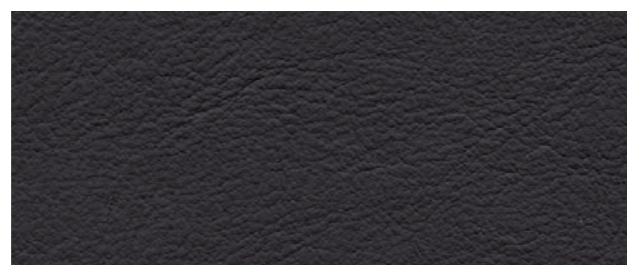

**NASW**  
Black Nappa Leather



**ZBC8**  
Platinum / Black Full Merino Leather  
BMW Individual

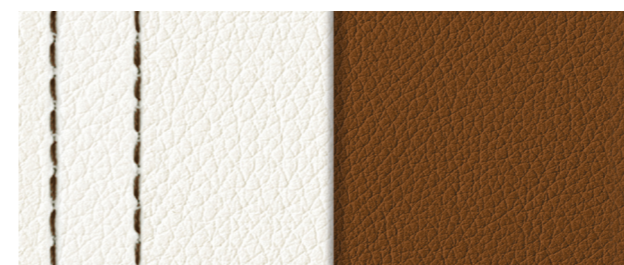

**ZBOB**  
Opal White / Amaro Brown Full  
Merino Leather  
BMW Individual

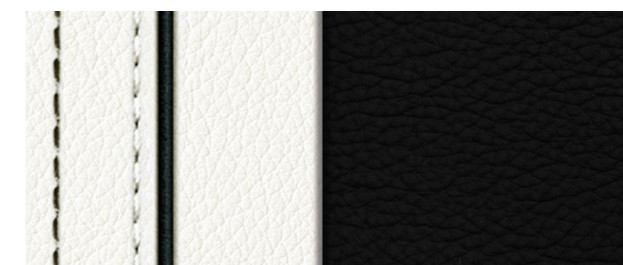

**ZBOW**  
Opal White Full Merino Leather  
BMW Individual

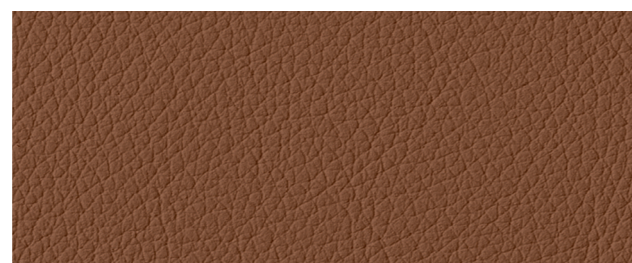

**ZBP5**  
Amaro Brown Full Merino Leather  
BMW Individual

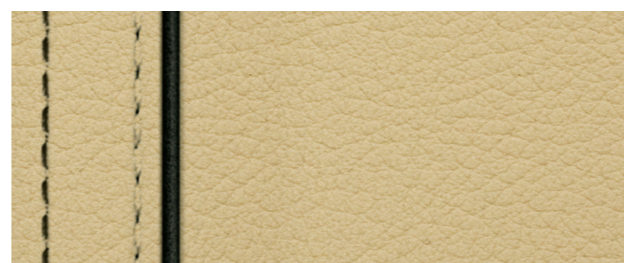

**ZBP6**  
Champagne Full Merino Leather  
BMW Individual

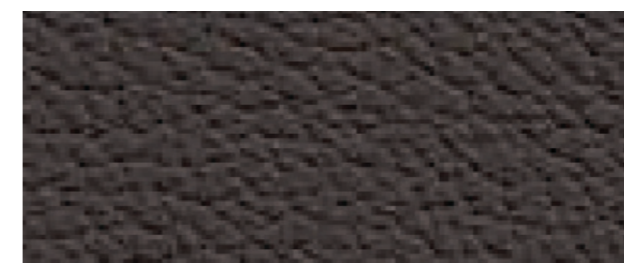

**ZBWT**  
Canyon Brown Full Merino Leather  
BMW Individual



# BMW ALPINA B6 INTERIOR TRIMS



**XEY**  
ALPINA Myrtle Wood trim  
BMW Individual

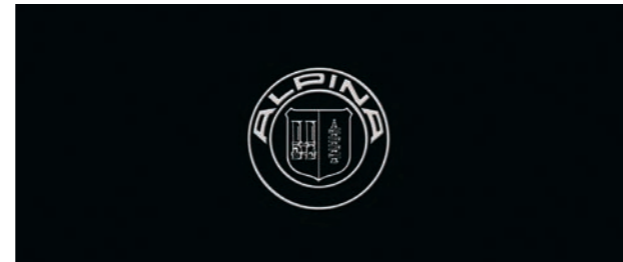

**XEZ**  
ALPINA Piano Black trim  
BMW Individual

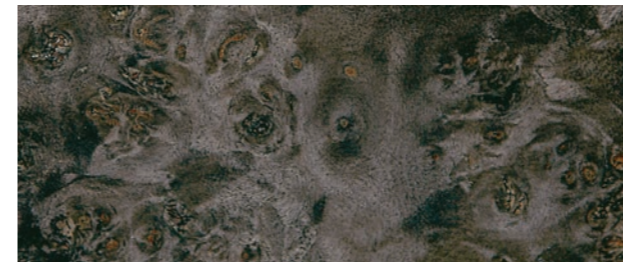

**4AS**  
Gray Poplar Wood trim



**4B9** Brushed Aluminum trim



**4E0**  
Fineline Brown Wood trim

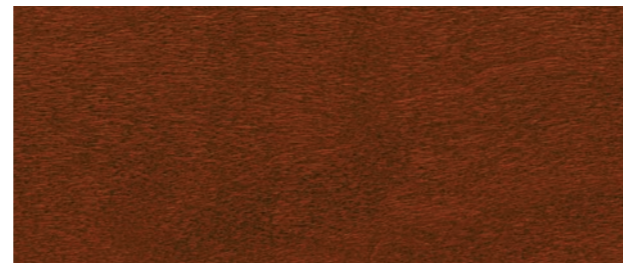

**XE5**  
Dark Red Sycamore Wood trim  
BMW Individual

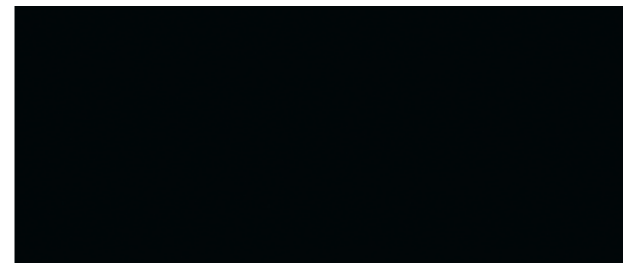

**XE7**  
Piano Black trim  
BMW Individual



**XEX**  
White Ash Grain Wood trim  
BMW Individual





# BMW ALPINA B6 PACKAGES

## **DRIVER ASSISTANCE PLUS**

Active Blind Spot Detection  
Active Driving Assistant or<sup>1</sup>  
Active Cruise Control (ACC)  
with Stop & Go + Active Cruise Control<sup>2</sup>  
Daytime Pedestrian Protection  
Frontal Collision Warning with  
City Collision Mitigation  
Side- and Top-view Cameras  
Speed Limit Info

## **EXECUTIVE PACKAGE**

Heated steering wheel  
Power rear-window and rear  
side-window sunshades  
Ventilated front seats  
Active front seats  
Heated rear seats  
Ceramic controls  
Head-up Display

<sup>1</sup> Active Driving Assistant is not a substitute for the driver's own responsibility in maintaining safe control of the vehicle.

<sup>2</sup> After evaluating the road, traffic and visibility conditions, the driver must decide whether and how Active Cruise Control is to be used.

Get the latest information on standard and optional features, packages and technical specifications. Visit [bmwusa.com](http://bmwusa.com) and select the BMW model of your choice.



# BMW ALPINA B6 WHEELS & TECHNICAL DATA



**ALPINA CLASSIC light alloy wheels (Style B6),** 20 x 8.5 front, 20 x 10.0 rear; and 255/35 front, 295/30 rear performance<sup>1,2</sup> or all-season tires.<sup>1</sup> Also available as an option: 21 x 8.5 front, 21 x 10.0 rear; and 255/35 front, 295/30 rear performance<sup>1,2</sup> or all-season tires<sup>1</sup>

Wheel and tire specifications are subject to change. Get the latest information on the availability of standard and optional wheels and tires, packages and technical specifications. Visit [bmwusa.com](http://bmwusa.com) and select the BMW model of your choice.

<sup>1</sup>BMW ALPINA vehicles do not come equipped with a spare wheel and tire. Driving over rough or damaged road surfaces, as well as debris, curbs and other obstacles, can cause serious damage to wheels, tires and suspension parts. This is more likely to occur with low-profile tires, which provide less cushioning between the wheel and the road. Be careful to avoid road hazards and reduce your speed, especially if your vehicle is equipped with low-profile tires.

<sup>2</sup> Performance tires are not recommended for driving in snowy and icy conditions.

<sup>3</sup>BMW AG preliminary test results. Actual acceleration results may vary, depending on specification of vehicle, road and environmental conditions, testing procedures and driving style. These results should be used for comparison only, and verification should not be attempted on public roads. BMW urges you to obey all posted speed laws and always wear safety belts.

Get the latest information on the availability of standard and optional wheels and tires, packages and technical specifications. Visit [bmwusa.com](http://bmwusa.com) and select the BMW model of your choice.

ENGINE	4.4-liter ALPINA Bi-Turbo V-8
OUTPUT @ RPM	600 hp @ 6000 / 590 lb-ft @ 3500–4500
0–60 MPH (sec) <sup>3</sup>	3.7
CITY / HIGHWAY MPG	15/24

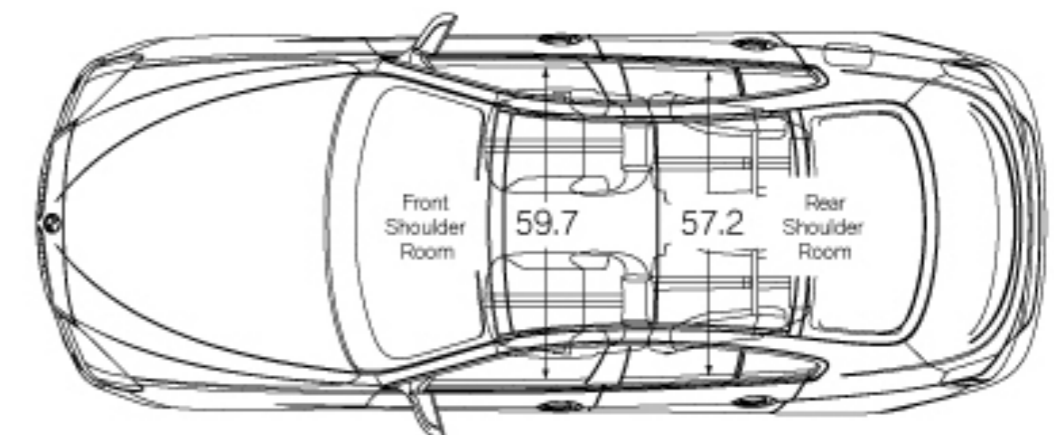
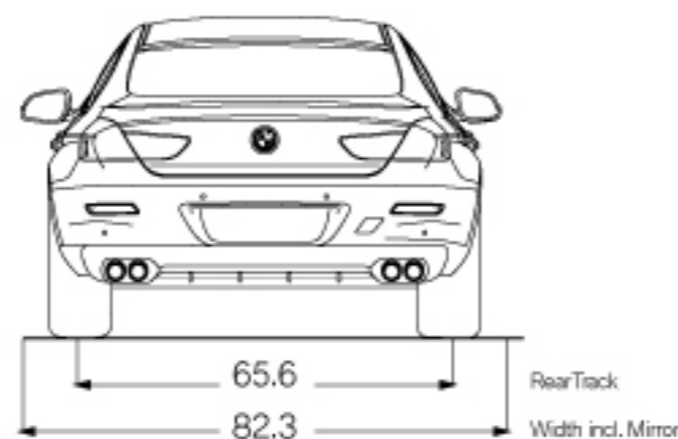
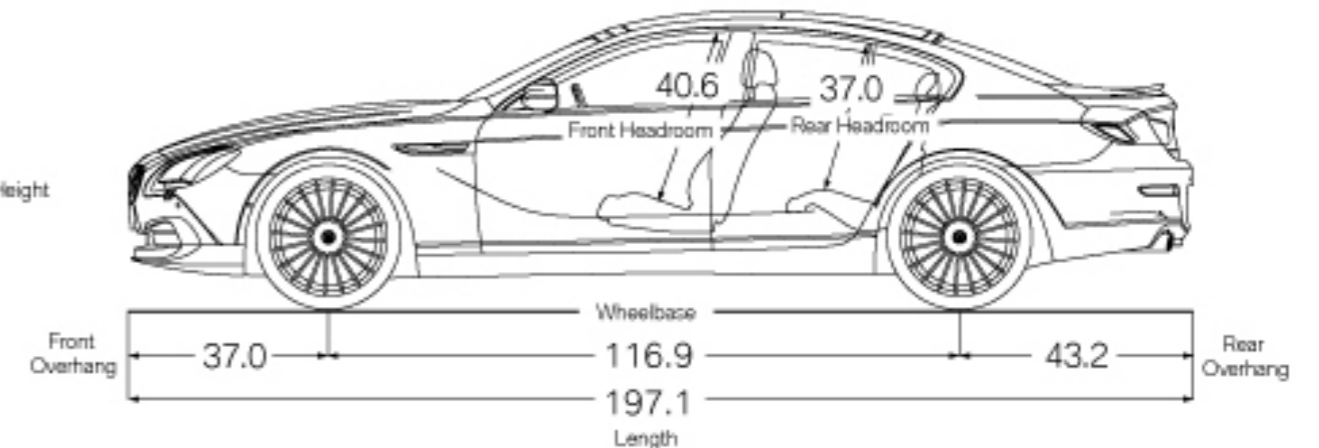
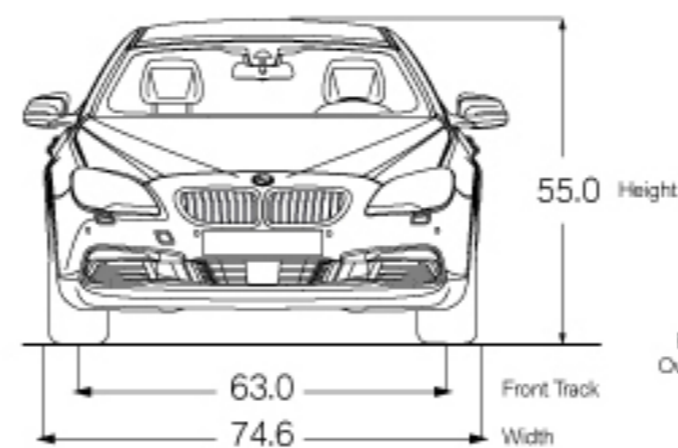

All dimensions in technical drawings are given in inches. Dimensions shown apply to Alpina B6.