

2009  
BMW M5 Sedan  
BMW M6 Coupe  
BMW M6 Convertible



The Ultimate  
Driving Machine®





BMW M engineers: masters of increasing muscle – without steroids.





A 500-horsepower  
understatement.



Supercar or  
executive sedan?

Yes.





All systems go.  
Ready for takeoff.





M-style performance – optimized in every detail.





The M6 delivers electrifying  
performance. In every role.





Endlessly compelling.  
So is the ocean.

Only BMW could create a low-slung  
vehicle with such a high profile.







Room for four – but only  
one lucky enough to drive.

A top-down fantasy, meticulously  
assembled from the ground up.



Drivers cannot live  
on adrenaline alone.









Take an outdoors vacation.  
In any gear.



Inside this beautiful body:  
a perfect V-10.



- 1 Aerodynamic low-profile M6 Convertible softtop in black; also available in gray.
- 2 Characteristic M Car dual chrome-plated stainless-steel tailpipes.
- 3 White turn signal indicators incorporated into the M side gills.
- 4 M auto-dimming side-view exterior mirrors with power fold-up feature.
- 5 Lightweight M6 carbon-fiber roof is four times lighter than steel.<sup>1</sup>
- 6 19" M Radial Spoke (Style 167M) light cast alloy wheels.<sup>2</sup>

<sup>1</sup>Available in M6 Coupe only.  
<sup>2</sup>Due to low-profile tires, please note: wheels, tires and suspension parts are more susceptible to road hazard and consequential damages. Performance tires not recommended for driving in ice and snow.





- 1 Door-sill trim with illuminated M6 logo.
- 2 Instrument panel dashboard in optional Full Merino Leather.
- 3 Illuminated SMG selector lever.
- 4 Information Display with white illuminated surrounds on the speedometer and tachometer and red instrument needles.
- 5 Optional M-mode Head-up Display.















It takes a  
high-performance transmission  
to harness 500 horses.





Keep your eyes on the prize:  
perfectly executed gearshifts.

## Recommended color combinations

Interior colors	Merino Leather (Extended) <sup>1</sup>			Perforated Merino Leather (Full) <sup>2,3</sup>			Merino Leather (Full) <sup>3,4</sup>				
Upholstery color	Silverstone II	Sepang	Black	Silverstone II	Sepang	Black	Silverstone II	Sepang	Portland Brown	Indianapolis Red	Black
<b>Exterior paint colors<sup>5</sup></b>											
<b>300</b> Alpine White Non-metallic	●	●	●	●		●	●			●	●
<b>A29</b> Silverstone Silver Metallic	●		●	●		●				●	●
<b>A52</b> Space Gray Metallic	●		●	●		●				●	●
<b>440</b> Stratus Gray Metallic <sup>6</sup>		●	●		●	●		●		●	●
<b>A32</b> Sepang Bronze Metallic		●	●		●	●		●	●		●
<b>A31</b> Indianapolis Red Metallic			●			●				●	●
<b>A30</b> Interlagos Blue Metallic	●		●	●		●	●				●
<b>A35</b> Monaco Blue Metallic	●		●	●		●	●				●
<b>475</b> Black Sapphire Metallic	●	●	●	●	●	●	●	●	●	●	●
<b>416</b> Carbon Black Metallic	●	●	●	●	●	●	●	●	●	●	●
<b>Interior trim</b>											
<b>737</b> Brushed Aluminum Shadow <sup>7</sup>											
<b>4MC</b> Carbon Fiber Black <sup>8</sup>											
<b>4ME</b> Walnut Madeira Wood <sup>9</sup>											
<b>4MK</b> Olive Ash Wood <sup>10</sup>											

Please note: The optional M5 multi-function front seats with Perforated Merino Leather are upholstered in the same color leather, front and back. The backs of all other seats are upholstered in Black Leather.

<sup>1</sup> Standard in the M5 and M6; includes Anthracite Cloth headliner and side pillars.

<sup>2</sup> Optional in the M5; requires optional Ventilated Seats feature and optional multi-function front seats with Active width-adjustment feature. Not available in the M6.

<sup>3</sup> Optional Full Leather includes leather-covered instrument panel, center console and door panels, and Anthracite Alcantara roofliner. Anthracite Alcantara roofliner not available in the M6 Convertible.

<sup>4</sup> Optional in the M5 and M6.

<sup>5</sup> All exterior paint colors are standard (if available) on the M5 and M6.

<sup>6</sup> Available on the M6; not available on the M5.

<sup>7</sup> Standard in the M5; not available in the M6.

<sup>8</sup> Optional in the M6; not available in the M5.

<sup>9</sup> Standard in the M6; no-cost option in the M5.

<sup>10</sup> No-cost option in the M5 and M6.

### M6 Convertible softtop colors

**388** Black (standard)

**389** Gray (optional)

Please note: Either softtop can be selected with any color combination.

<b>Performance and efficiency</b>	<b>M5 Sedan</b>	<b>M6 Coupe</b>	<b>M6 Convertible</b>
5.0-liter, 40-valve V-10 engine with M high-pressure Double-VANOS "steplessly" variable valve timing	●	●	●
10 individual throttle butterflies, electronically controlled	●	●	●
G-sensitive semi-dry-sump lubrication system	●	●	●
Oil coolant heat exchanger	●	●	●
Digital Motor Electronics (DME) with on-board diagnostics	●	●	●
3-way catalytic converter with heated oxygen sensor	●	●	●
7-speed Sequential Manual Gearbox (SMG) with DRIVELOGIC	●	●	●
6-speed manual transmission <sup>1</sup>	○	○	○

<b>Handling, ride and braking</b>	<b>M5 Sedan</b>	<b>M6 Coupe</b>	<b>M6 Convertible</b>
Dynamic Stability Control (DSC) with M Dynamic Mode (MDM)	●	●	●
All Season Traction with M Variable Differential Lock	●	●	●
Vehicle-speed-sensitive variable-assist power steering (M Servotronic) with M Driving Dynamics Control (2 settings – throttle and steering)	●	●	●
Aluminum double-pivot strut-type front suspension and 4-link integral rear suspension	●	●	●
Independent suspension with M calibration (stiffened dampers, springs and anti-roll bars; modified rear axle geometry)	●	●	●
Electronic Damping Control with Comfort, Normal and Sport mode	●	●	●
Lightweight, double-joint spring strut front axle with aluminum crossbar	●	●	●
Lightweight integral rear axle	●	●	●
4-wheel BMW M vacuum-assisted ventilated, cross-drilled anti-lock compound disc brakes (ABS)	●	●	●

<b>Interior seating and trim<sup>2</sup></b>	<b>M5 Sedan</b>	<b>M6 Coupe</b>	<b>M6 Convertible</b>
18-way power-adjustable BMW M sport front seats, including adjustable seatback side bolsters, headrests, 4-way lumbar and 2-way thigh support, and 2-setting memory system for both front seats	●		
14-way power-adjustable BMW M sport front seats, including adjustable seatback side bolsters and 4-way lumbar support; 2-way manual thigh support and adjustable headrests; and 3-setting driver's-seat memory system		●	
14-way power-adjustable BMW M sport front seats, including power adjustable headrests and 4-way lumbar support; 2-way manual thigh support; and 3-setting driver's-seat memory system			●
20-way power multi-function front seats – include standard power seat functions, plus additional power adjustment functions for shoulder and thigh support, backrest width and lumbar support (contour and position), 2-way manual lateral adjustment for Comfort headrest, 2-driver memory system	○		
Front Ventilated Seats (requires optional Perforated Merino Leather upholstery and optional multi-function front seats)	○		
Merino Leather upholstery (Extended)	●	●	●
Merino Leather upholstery (Full)	○	○	○
Perforated Merino Leather upholstery (Full) (requires optional Ventilated Seats feature and optional multi-function seats)	○		
Front and rear center armrests	●		
Adjustable front center armrest		●	●
M-badged door sills	●	●	●

- Standard
- Optional

<sup>1</sup> Steering wheel paddles and DRIVELOGIC center-console DSC button are not available with optional manual transmission.

<sup>2</sup> See Combinations chart on preceding page for requirements on ordering upholstery, seats and trim.



Exterior	M5 Sedan	M6 Coupe	M6 Convertible
M Radial Spoke (Style 166M) light cast alloy wheels, 19 x 8.5 front/19 x 9.5 rear, with 255/40 front, 285/35 rear performance tires <sup>4</sup>	●		
M Radial Spoke (Style 167M) light cast alloy wheels, 19 x 8.5 front/19 x 9.5 rear, with 255/40 front, 285/35 rear performance tires <sup>4</sup>		●	●
Tire Pressure Monitor system	●	●	●
M Mobility System (includes lifetime BMW Roadside Assistance for tire assistance)	●	●	●
BMW M front spoiler, rear apron/air diffuser	●	●	●
M rear spoiler	●		
Wraparound body-color bumpers with hydraulic energy absorbers and front-compressible elements	●	●	●
Xenon Adaptive Headlights with dynamic auto-leveling feature and individual illuminating rings on all 4 headlights	●	●	●
High-beam Assistant	○	○	○
Side-view mirrors with electrochromic auto-dimming, power fold-up feature and automatic tilt-down of passenger's side-view mirror when vehicle is shifted into reverse gear	●	●	●
Heated side-view mirrors, windshield washer jets and door locks	●	●	●
Rain-sensing windshield wipers with Automatic headlight control and headlight washing system	●	●	●
Park Distance Control with front and rear sensors	●	●	●
Twin-chamber exhaust system with twin dual chrome-plated tailpipes	●	●	●
Choice of standard or metallic paint	●	●	●

Audio system	M5 Sedan	M6 Coupe	M6 Convertible
Logic7 Surround Sound anti-theft AM/FM stereo CD audio system with MP3 capabilities, 13 upgraded speakers <sup>5</sup> (including 2 subwoofers), Digital Sound Processing (DSP), Radio Data System (RDS), Auto-Store and 3-channel FM diversity antenna	●	●	● <sup>5</sup>
Enhanced Premium Sound audio system includes 16 upgraded speakers <sup>6</sup>	○	○	○ <sup>6</sup>
HD Radio™ with "multicast" FM station reception (can be ordered in combination with Logic7 or Premium Sound audio system)	○	○	○
SIRIUS® Satellite Radio with one-year subscription <sup>7</sup>	○	○	○
iPod® and USB adaptor (includes cable connector)	○	○	○

- Standard
- Optional

<sup>4</sup> Due to low-profile tires, please note: wheels, tires and suspension parts are more susceptible to road hazard and consequential damages. Performance tires not recommended for driving in ice and snow. Please note: M5 Sedan, M6 Coupe and M5 Convertible are not equipped with a spare tire and wheel. They include M Mobility System, which offers lifetime BMW Roadside Assistance for tire assistance.

<sup>5</sup> M6 Convertible Logic7 system includes 11 speakers.

<sup>6</sup> M6 Convertible Enhanced Premium Sound system includes 12 speakers.

<sup>7</sup> Please visit your authorized BMW center for details on equipment.

<b>Instrumentation and controls</b>	<b>M5 Sedan</b>	<b>M6 Coupe</b>	<b>M6 Convertible</b>
M multi-function leather-wrapped sport steering wheel with SMG paddles, M Drive function and cruise control	●	●	●
M-design instrument cluster with white-illuminated gauges, oil temperature gauge, and variable warning segment on tachometer	●	●	●
Service Interval Indicator	●	●	●
Check Control vehicle monitoring system	●	●	●
Start/Stop button	●	●	●
External temperature display	●	●	●
On-board computer	●	●	●
Navigation system (includes 8.8" screen with 16 x 9 format and Real Time Traffic Information)	●	●	●
Head-up Display with additional M-specific display functions, including speed, dynamic engine speed range, and shift lights <sup>8</sup>	○	○	○
Voice Command System	●	●	●
Vehicle & Key Memory	●	●	●

<b>Comfort and convenience</b>	<b>M5 Sedan</b>	<b>M6 Coupe</b>	<b>M6 Convertible</b>
Automatic Climate Control with separate left/right temperature and air distribution controls, with automatic air recirculation	●	●	●
3-stage heated front seats	●	●	●
3-stage heated rear seats	○		
Heated steering wheel	○		
2-way power glass moonroof with remote, expanded "one-touch" operation, anti-trapping feature, and sliding interior sunshade	●		
Reinforced carbon-fiber roof		●	
Fully lined power softtop roof with heated glass rear window			●
Power tilt and telescopic steering wheel with automatic tilt-up	●	●	●
Power windows with key-off and "one touch" up and down operation both front and rear, anti-trapping feature, opening from remote, and closing from exterior lock	●	● <sup>9</sup>	●
Power rear-window sunshade and manual rear side-window sunshades	○		
Remote control key	●	●	●
Comfort Access keyless entry with multi-function remote control	○	○	○
BMW Ambiance Lighting	●	●	●
Interior courtesy lights with automatic dimming function	●	●	●
Front map lights and rear reading lights with separate left/right controls	●	●	●
Dual front sun visors with illuminated mirrors	●	●	●
Ground-illuminating lights in door handles	●	●	●
Integrated 3-button Universal garage-door opener	●	●	●
Heated driver's door lock and rear window defroster	●	●	●
Split fold-down through-load rear seats and ski bag	○		
Ski bag		●	●
Soft-close doors and soft-closing trunk lid feature	○	○	○
Fully finished trunk with tool kit and interior trunk release	●	●	●
Power outlet in trunk, front passenger's footwell and back of center console	●		
Glove compartment with rechargeable take-out flashlight	●	●	●

● Standard  
○ Optional

<sup>8</sup> Not available with green band windshield; M5 with manual transmission will not show gear information or shift lights.

<sup>9</sup> Power rear side-window functions not available in M6 Coupe.

Safety and security	M5 Sedan	M6 Coupe	M6 Convertible
Driver's and passenger's front airbag supplemental restraint system (SRS) with advanced technology: dual-threshold, dual-stage deployment; and front-passenger seat sensors designed to prevent unnecessary airbag deployment	●	●	●
Front- and rear-seat Head Protection System (AHPS II)	●		
Front-seat Head Protection System (AHPS II)		●	
Rollover Protection System			●
Front-door-mounted side-impact airbags	●	●	●
Automatic front safety belt pretensioners	●	●	●
Rear-seat side-impact airbags and automatic pretensioners on rear outboard safety belts	○		
Automatic locking retractors (ALR) on all passenger-seat safety belts (for installation of child-restraint seats)	●	●	●
Interlocking door anchoring system	●	●	●
BMW's Advanced Safety System for integrated deployment of safety features	●	●	●
Impact sensor that activates Battery Safety Terminal disconnect of alternator, fuel pump and starter from battery	●	●	●
Coded Driveaway Protection	●	●	●
Remote keyless entry security alarm system with selective unlocking and double-lock features (programmed at BMW center), remote trunk opening, interior motion detector, and panic feature	●	●	●
Adaptive Brake Lights	●	●	●
BMW Assist™ with <b>Bluetooth</b> ® wireless technology for hands-free calling (with <b>Bluetooth</b> enabled mobile phone), phonebook downloading and speech recognition capabilities	●	●	●

BMW Services	M5 Sedan	M6 Coupe	M6 Convertible
BMW Ultimate Service™	●	●	●
M Driving Experience at the BMW Performance Center in Spartanburg, SC <sup>12</sup>	●	●	●

● Standard  
○ Optional

<sup>12</sup> For more information on the M Driving Experience at the BMW Performance Driving School, visit [bmwusa.com/performancecenter](http://bmwusa.com/performancecenter) or call toll-free 1-877-996-5999.

<b>Weight</b>		<b>M5 Sedan</b>	<b>M6 Coupe</b>	<b>M6 Convertible</b>
Unladen	lb	4012	3909	4398
Weight distribution, front/rear	%	52.2/47.8	53.5/46.5	49.9/50.1

<b>Engine</b>		<b>M5 Sedan</b>	<b>M6 Coupe</b>	<b>M6 Convertible</b>
Liters/cylinders/valves per cylinder		5.0/V-10/4	5.0/V-10/4	5.0/V-10/4
Displacement	cu cm	4999	4999	4999
Bore/Stroke	inch	3.62/2.96	3.62/2.96	3.62/2.96
Nominal output @ rpm	hp	500 @ 7750	500 @ 7750	500 @ 7750
Max torque @ rpm	lb-ft	383 @ 6100	383 @ 6100	383 @ 6100
Compression ratio	:1	12.0	12.0	12.0

<b>Transmission</b>		<b>M5 Sedan</b>	<b>M6 Coupe</b>	<b>M6 Convertible</b>
7-speed SMG gear ratios	I/II/III	:1 3.99/2.65/1.81	3.99/2.65/1.81	3.99/2.65/1.81
	IV/V/VI	:1 1.39/1.16/1.00	1.39/1.16/1.00	1.39/1.16/1.00
	VII/R	:1 0.83/3.99	0.83/3.99	0.83/3.99
	Final drive ratio	:1 3.62	3.62	3.62
6-speed manual gear ratios	I/II/III	:1 4.05/2.40/1.58	4.05/2.40/1.58	4.05/2.40/1.58
	IV/V/VI/R	:1 1.19/1.00/0.87/3.68	1.19/1.00/0.87/3.68	1.19/1.00/0.87/3.77
	Final drive ratio	:1 3.62	3.62	3.62

<b>Performance</b>		<b>M5 Sedan</b>	<b>M6 Coupe</b>	<b>M6 Convertible</b>
Drag coefficient	C <sub>d</sub>	0.31	0.32	0.34
Top speed <sup>1</sup>	mph	155	155	155
Acceleration 0-60 mph <sup>2</sup>	sec	4.5	4.5	4.6

<b>Fuel consumption<sup>3</sup></b>		<b>M5 Sedan</b>	<b>M6 Coupe</b>	<b>M6 Convertible</b>
7-speed SMG transmission – City/highway	mpg	11/17	11/17	11/17
6-speed manual transmission – City/highway	mpg	11/17	11/17	11/17

<b>Tires and Wheels</b>		<b>M5 Sedan</b>	<b>M6 Coupe</b>	<b>M6 Convertible</b>
Tire dimensions (performance tires) <sup>4</sup>	front	255/40	255/40	255/40
	rear	285/35	285/35	285/35
Wheel dimensions, front/rear		19 x 8.5 / 19 x 9.5	19 x 8.5 / 19 x 9.5	19 x 8.5 / 19 x 9.5
Material		light cast alloy	light cast alloy	light cast alloy

<b>Brakes</b>		<b>M5 Sedan</b>	<b>M6 Coupe</b>	<b>M6 Convertible</b>
Front – diameter	inch	14.7	14.7	14.7
Rear – diameter	inch	14.6	14.6	14.6

Please note: Technical specifications are subject to change without notice.

<sup>1</sup>Top speed limited electronically.

<sup>2</sup>BMW AG test results.

<sup>3</sup>EPA-estimated figures are for comparison purposes only. Your actual mileage will vary, depending on speed, driving habits, trip length and driving conditions; actual mileage may be lower.

<sup>4</sup>Due to low-profile tires, please note: wheels, tires and suspension parts are more susceptible to road hazard and consequential damages. Performance tires not recommended for driving in ice and snow conditions.

M5 Sedan

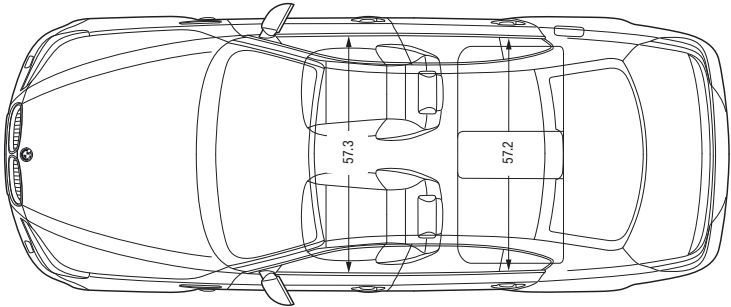
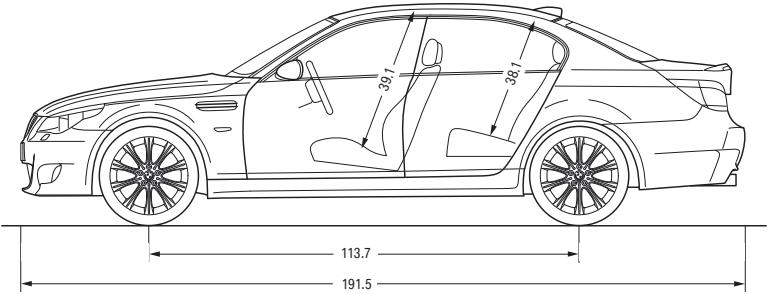
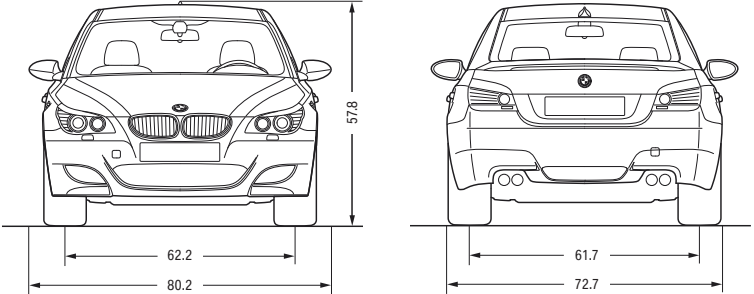

All dimensions of technical drawings in inches.

**M6 Coupe**

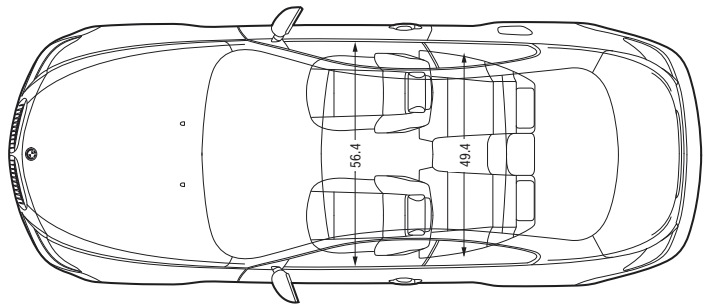
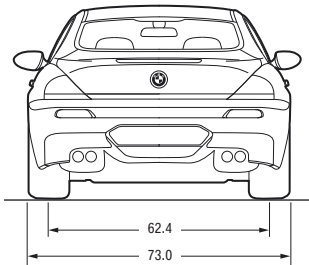
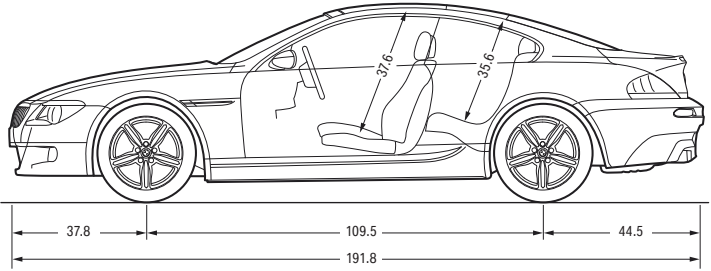
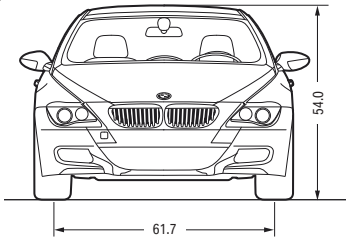

**M6 Convertible**

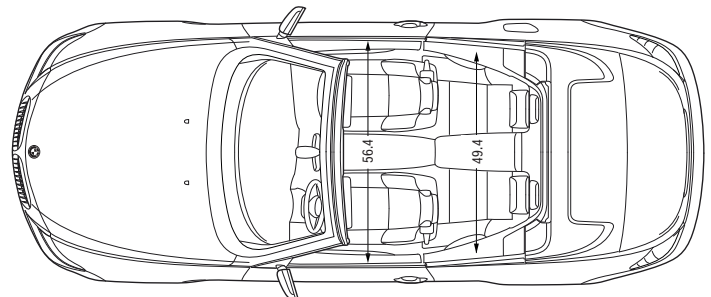
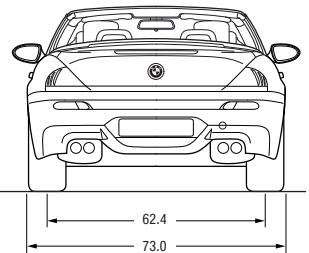
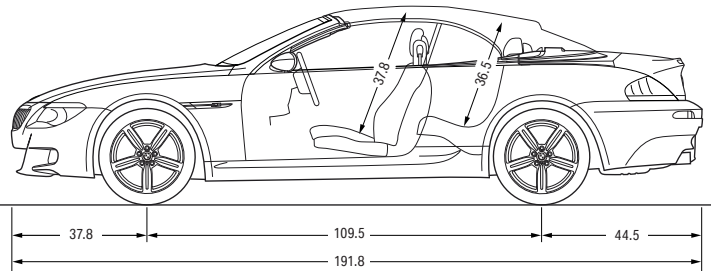
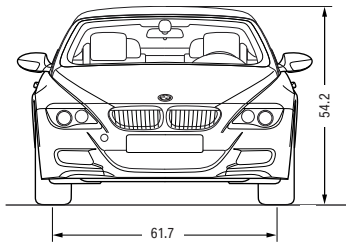

All dimensions of technical drawings in inches.

**More about BMW**

bmwusa.com  
1-800-334-4BMW



**The Ultimate  
Driving Machine®**

**BMW and the environment.**

BMW is a strong proponent of the environment and social responsibility. It is important to manage the earth's resources responsibly, and not jeopardize the needs of future generations. That is why BMW makes vehicles that minimize adverse environmental impact, from production (pollution prevention and waste minimization at the plant) through owner use (low emissions) to eventual disposal (easy drainability of all fluid-related components and easy neutralization of all pyrotechnic devices).

This effort has been recognized worldwide, and as a result, we are pleased to have received numerous environmental honors. In the U.S., for example, the Environmental Protection Agency accepted BMW's Spartanburg, SC production and manufacturing facility as a charter member of the agency's National Environmental Performance Track. Internationally, BMW AG – the parent company of both BMW of North America and BMW Manufacturing Co., Spartanburg, SC – was the first automotive company to be represented on the Dow Jones Sustainability Group Index, and has remained on the Index ever since. At BMW, we strive for high performance in everything we do.

U.S. Importer: BMW of North America, LLC, Woodcliff Lake, NJ 07677. All illustrations and specifications contained in this brochure are based on the latest product information available at the time of printing. BMW reserves the right to make changes at any time, without notice, in colors, materials, equipment, specifications and models. BMW may, subject to legal requirements, determine the Model Year designation of its vehicles. The Model Year designation on any particular model may be longer or shorter than 12 months. Some vehicles pictured may contain non-U.S. equipment. Some models may be shown with optional equipment. While BMW NA makes all reasonable efforts to provide accurate information in this brochure, there is no guarantee or warranty of accuracy. Furthermore, we do not assume any liability for the accuracy or completeness of information presented. This brochure shall not be used or relied upon as a substitute for information that is available from your BMW center. Further information can be obtained from your authorized BMW center or bmwusa.com.

©2008 BMW of North America, LLC. Not to be reproduced wholly or in part without written permission of BMW NA. The BMW name, model names and logo are registered trademarks.

The **Bluetooth** word mark and logos are owned by the **Bluetooth SIG, Inc.** and any use of such marks by BMW is under license. iPod is a registered trademark of Apple Inc. Other trademarks and trade names are the property of their respective owners.

**BMW recommends** 

