

BMW X1

X1 sDrive28i
X1 xDrive28i
X1 xDrive35i



The Ultimate
Driving Machine®



THE BMW X1.

LEAN POWER, LUXURIOUSLY CRAFTED.

BMW EfficientDynamics
Less emissions. More driving pleasure.



BECOME ONE WITH THE INNOVATIVE X1.

Find a new path. Make your own rules. The BMW X1 gives you the key to a new formula of all-wheel-drive vehicle. Refusing to sacrifice sporty looks or comfort, spirited performance or practicality, the X1 is the ideal balance of power, versatility and style. Get behind the wheel and discover everything you've ever wanted in one great vehicle. The BMW X1: it's ready for virtually any adventure. Are you?



The BMW X1

ONE VEHICLE. X POSSIBILITIES.

06 Exterior design and BMW Lines

Ready for take-off.

12 Driving dynamics

Sense of freedom included.

16 Interior design

The world looks better from the inside.

22 Interior design and BMW Lines

A fresh approach for a more natural interior.

24 Innovations

Open to new ideas.

bmwusa.com/x1

Technology

MORE SPONTANEOUS THAN EVER.

30 BMW ConnectedDrive

In touch with your world.

34 BMW EfficientDynamics

The technology package for fewer emissions and more driving pleasure.

36 BMW TwinPower Turbo engines

Maximum performance from minimum fuel consumption.

38 Chassis and safety features

Innovative systems for more driving pleasure, as well as active and passive safety systems.

Equipment

AS INDIVIDUAL AS YOU ARE.

42 BMW X1

44 BMW xLine

46 BMW Sport Line

48 BMW M Sport Line

50 Exterior colors

51 Interior colors, upholsteries and trims

52 Design Line upholsteries and trims

53 Recommended color combinations

54 Equipment features and options

60 Original BMW Accessories

Overview

ALL THE FEATURES AT A GLANCE.

61 Build Your Own

62 Technical data

64 BMW Services

Exclusive offers for BMW customers.

bmwusa.com



Want the inside scoop on BMW?
You can find us on Facebook® at
[facebook.com/bmwusa](https://www.facebook.com/bmwusa).

Editorial

INSTANT WINNER – SMALL WONDER.

How can the world's first sub-compact premium SUV-style vehicle deliver a sport sedan-like driving experience with enough space to comfortably fit up to five? Simple: it's a product of BMW engineering magic. After conquering the rest of the world, the BMW X1 SAV® is making its U.S. debut, and it's already garnering rave reviews for combining many of BMW's strongest features in one dynamic vehicle.

Don't let its lean stance fool you. The X1 formula offers a banquet of desirable traits – such as potent, fuel-efficient engine options. Bespoke styling. Plenty of legroom and headroom, as well as ample cargo storage space. BMW's latest driving and connectivity technologies. And with the added capabilities of available xDrive – BMW's intelligent all-wheel-drive system – no road is too challenging. The X1: introducing substance into the sub-compact SUV category.



X FACTOR, REDEFINED.

► Already hailed as a conqueror of roads and reviewers overseas, the BMW X1 is making its triumphal appearance on the American road. With its winning combination of sporty design, versatile power, groundbreaking technology and modern aesthetics, a global victory lap is just down the road.

A refined approach is the key to the X1's appeal. Produced in BMW's Plant Leipzig, the X1 gives drivers and passengers a new flavor of X. With its lean body, dynamic styling, light weight and aggressive handling, the X1 shows off a considerable flair for track-inspired performance. No matter which model you choose – including two all-wheel-drive versions and, new for BMW, a rear-wheel-drive version – BMW's smallest X vehicle proves it's all about personality.





►► **Dynamic, eye-catching and immediately identifiable, the X1 shows off at every turn. From the muscular front end to BMW signature L-shape taillights, the X1 attracts followers from all walks of life.**

DESIGNED TO X-CEL.

Vibrant, muscular, full of energy: the X1, though a part of the celebrated BMW X family, shows itself to be a unique vehicle in its own right. Seen from the front, the X1 delivers a great sense of confidence. Wide wheel arches, a bold seven-slat twin kidney grille, and a three-dimensional surround across the headlights immediately signal the X1's rugged BMW DNA. In fact, looking directly at the front end, you can make out a subtle but powerful "X" shape, formed in the body and panel work. But make no mistake, this is no boxy, utilitarian design; a sweeping hood, long wheelbase and set-back passenger compartments suggest the X1's integration of a more refined driving experience. Additional cues, such as a chrome accent strip atop the twin Corona headlight-rings, as well as an LED accent light, enhance the X1's elegant presence.

BMW designers took great care in crafting a suitable exterior "personality" for the X1: spontaneous, performance-driven and, most of all, fun. From the 18-inch alloy wheels to its sporty roof rails available in three different finishes, the X1 is a vehicle that says, Where do you want to go today? Whatever your answer, it's game.



Get the latest information on BMW standard and optional features, packages and technical specifications. Visit bmwusa.com, select the BMW model of your choice, and click on "Features & Specs."



► Unique among the competition and even BMW, the X1 design language boasts distinctive lines, contours and accents that make it stand out from the pack.

Seen from the side, the X1 boasts three bold lines that create a sense of power and confidence. The top contour line rises sharply to the rear, interacting with the lower sill line to create a dynamic wedge shape, while a distinctive middle character line adds a dynamic touch. Another BMW signature, the Hofmeister kink, appears in conjunction with the character line and special window graphics. Surfaces and contours are bold, distinct and crisp; the flowing front end, sides and rear create a symphonic connection between the various elements. Body components are finished with an exacting degree of sophistication, including the painted front bumpers, side sills and a trim bar that separates the lower air intakes with a horizontal line. Even the underfloor protection plate is finished in a striking silver color, which can be matched with a silver-color roof rail. This versatile vehicle shows how flair is a great match with functionality.



**BEHOLD.
BE
MOVED.**



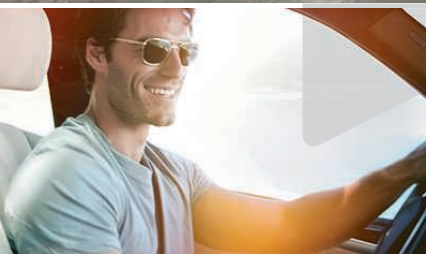

X1 TO GO – HOWEVER YOU'RE GOING.

►► **Settle in and take the wheel – you're in for a thrilling drive. Whether pushing the engine to its limits, or putting xDrive intelligent all-wheel drive to the test, you'll find there's nothing the X1 can't handle.**

Tackling the tarmac, the X1 can open up virtually any driving experience. Are you the sporty, adventurous type who demands as much from your vehicle as you do from yourself? The X1 xDrive35i – available only in the U.S. – has power and traction at the ready, courtesy of a potent TwinPower Turbo six-cylinder engine and xDrive, BMW's intelligent all-wheel drive. Seeking rear-wheel-drive handling and a potent, efficient powerplant? The X1 sDrive28i delivers the goods with a stunningly responsive TwinPower Turbo four-cylinder engine. Or split the difference with the X1 xDrive28i's lean, efficient four-cylinder TwinPower Turbo dynamo and optimized traction of xDrive all-wheel drive. All three models can be upgraded with the M Sport Line for over-the-top, race-inspired styling and performance.

Get the latest information on BMW standard and optional features, packages and technical specifications. Visit bmwusa.com, select the BMW model of your choice, and click on "Features & Specs."



TAKE CONTROL.
FURTHER.



Whether pushing the engine to its limits, or putting xDrive intelligent all-wheel drive to the test, you'll find there's nothing the X1 can't handle.

What is it about pure adventure that we find so exhilarating? Whatever your next challenge may be, the X1 can help you overcome it. The power starts with award-winning BMW TwinPower Turbo engines that incorporate high-pressure direct fuel injection, Valvetronic and Double-VANOS – true engineering marvels and purveyors of peak BMW performance.

A whopping 300 hp and 300 lb-ft of torque in the X1 xDrive35i give you the muscle you need to climb virtually any hill or carve any turn. Yet this is not just about pure power. Thanks to BMW EfficientDynamics engineering principles, this engine is also a paradigm of efficiency and reduced emissions, so your footprint in the wild isn't marked by much more than tire tracks.

The four-cylinder X1 xDrive28i and X1 sDrive28i propel you in a similarly exciting way. Their engine produces a dynamic and impressive 240 hp and 260 lb-ft of torque. And it does so with an incredible amount of zip and efficiency, with the help of advanced engine technologies.

Both the X1 xDrive28i and X1 xDrive35i have an innovative feature in common: xDrive, BMW's intelligent all-wheel-drive system that provides optimized traction in even the most extreme conditions, and helps keep the X1 on course and ready for action. Also available: the cutting-edge Performance Control feature, which works in tandem with the xDrive system to add another level of responsive, sporty handling. Performance Control automatically alters engine and braking parameters during turning maneuvers, driving the outer wheels faster than the inner wheels. The net result: dynamic road feel that's more reminiscent of a roadster than an all-wheel-drive vehicle.

On the other hand, not all driving situations require the massive traction of xDrive. The X1 sDrive28i delivers crisp rear-wheel-drive handling with a level of power and torque that pins you to your seat. You can also add steering wheel-mounted paddle shifters to pursue your race-inspired driving dreams.

The X1 is just as sporting as you are. Chase after adventure and you're sure to find it, from mountain peaks to muddy passageways.



Get the latest information on BMW standard and optional features, packages and technical specifications. Visit bmwusa.com, select the BMW model of your choice, and click on "Features & Specs."



Tilted subtly in the driver's direction, the cockpit of the X1 gives functionality a new look - one that's as luxurious as it is convenient.



AT ONE WITH THE ROAD - AND THE WORLD.

There's an air of limitless energy about the BMW X1, and the vibe continues once you step inside and take the wheel. The semi-command seating position is the perfect vantage point to pilot this Sports Activity Vehicle. In fact, the driver-centric dash serves to enhance driver confidence.

The X1 cabin is designed to enhance driver control. All vehicle operation instrumentation, as well as climate and audio system controls, is driver-oriented, while a practical center console separates the driver and front-seat-passenger areas.

The instrument panel itself is divided by horizontal lines; together with the door panel design, this emphasizes the generous space inside the vehicle. This airy feeling continues in the "greenhouse" - the area surrounded by windows - which is optimized for excellent visibility in virtually all directions. Added touches of elegance hint at the X1's luxurious heritage: gorgeous silvertone trim surrounds the gear shift lever and center console cupholders; air vents are finished in high-gloss black; and the trim bar, in a contrasting color, flows from the lower section of the dash, guiding all sightlines back toward the road.

The iDrive Controller sits within quick reach, while the attractively finished 8.8-inch Control Display blends harmoniously into the dashboard. Add the Navigation system and enjoy an assortment of direct-selection

shortcut buttons on the center console. The Navigation system also gives you access to voice entry commands and a Bluetooth interface, allowing you to use your smartphone to maximum effect.

BMW ConnectedDrive, a suite of integrated communication features, operates as a virtual Mobile Office, allowing you to keep in touch with your contacts easily and efficiently. When you're not busy mapping out your next adventure, iDrive lets you dial in an impressive six-speaker sound system complete with built-in CD player and auxiliary input for connecting other media devices, including smartphones, MP3 players, tablets and more. Upgrade to the Harman Kardon Surround Sound System for peerless audio - ideal for providing the soundtrack to any trip.

Of course, the X1 also caters to track lovers. Select the M Sport Line and place a firm grip on the multi-function leather-wrapped M sport steering wheel, with paddle shifters right at your fingers. Sport seats provide all the support and adjustable bolstering you'll need, even while taking sharp corners. And a range of stunning M interior elements, such as the Anthracite headliner and exclusive trim choice, is just another way for the X1 to get your heart racing.

Although technically the smallest and leanest of BMW's X vehicles, the X1 never feels cramped or uncomfortable. The interior has been optimized for excellent legroom and headroom, both in front and back. This "wide-open" feeling is reflected in the rest of the cabin's layout – including the oversized Panoramic moonroof that provides amazing views of the world outside.

The rear section of the X1 can be quickly configured to maximize comfort and/or hauling flexibility. The 40/20/40 split-folding rear seat backrests can be angled 31 degrees for increased passenger comfort. When propped vertically – also known as Cargo position – storage capacity increases to 25 cubic feet. Fold the rear seats down completely for a generous 56 cubic feet of cargo space.



The rear window opens separately for quickly stowing smaller items. The large tailgate makes loading cargo a snap; thanks to the wide cargo opening and low loading sill, clearance is no problem.



SPACIOUS COMFORT
COMES NATURALLY.



GEARED TOWARD GEAR

From high-gloss roof rails to a spacious trunk flexibly designed to haul bikes, tents, coolers and sports gear, the X1 has enough versatility to make short work of big fun, so outdoor types feel right at home.



Normal position:

With the rear seats set in Normal position, you enjoy 25 cubic feet of space.

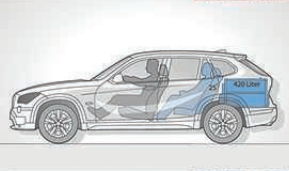

Cargo position:

In Cargo position (rear seats folded down flat), the area expands to 56 cubic feet.

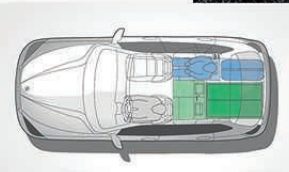

2 + 1:

Thanks to 40/20/40 split rear seats, an entire rear seat remains usable even when the luggage compartment is loaded, allowing three people to fit comfortably in the car.

Get the latest information on BMW standard and optional features, packages and technical specifications. Visit bmwusa.com, select the BMW model of your choice, and click on "Features & Specs."



Natural: xLine

The xLine represents the quintessential BMW X DNA: versatile, powerful, confident. From subtle trims to classic paint choices, each accent is meticulously sculpted to enhance the X1 as a whole.



Despite its compact size, the X1 goes to great lengths for comfort; the back seat area provides ample space for up to three passengers.

The X1 is also big on personality – and the level of personalizing you can do with it is simply icing on the cake. There are three “Lines” to choose from: the xLine, the Sport Line, and the M Sport Line. Each Line highlights specific X1 characteristics, with exclusive interior and exterior options, such as contrasting seat piping and wheel styles.

With the xLine, you'll discover striking Y Spoke 18-inch alloy wheels, High-Gloss Dark Copper or Finesse Bay Matte Wood interior trim, and a range

of xLine-specific upholstery colors and designs. The Sport Line adds a generous helping of track-inspired visual cues. Signal your sporting intentions with 18-inch Double Spoke light-alloy wheels and black side-mirror caps; inside, enjoy the added driving support of sport seats, as well as your choice of High-Gloss Black or Brushed Aluminum trim, along with unique color schemes, including several contrast-stitching offerings.

Bump up the customized cool factor with the M Sport Line. Choose between 18-inch or 19-inch M light alloy wheels with run-flat¹ performance tires.² A custom-tuned sport suspension and track-inspired Aerodynamic kit put a finer

point on the X1's handling. Shadowline exterior trim and high-gloss roof rails complete the exterior; inside, sport seats, an Anthracite headliner and a choice of M leather-wrapped steering wheels with or without paddle shifters set the performance note.

For the very first time, BMW offers the Ultimate Package: a combination of three separate packages – Driver Assistance Package, Premium Package and Technology Package – grouped together for maximum confidence, convenience and comfort.

¹ Run-flat tires do not come equipped with a spare tire and wheel.
² Driving over rough or damaged road surfaces, as well as debris, curbs and other obstacles, can cause serious damage to wheels, tires and suspension parts. This is more likely to occur with low-profile tires, which provide less cushioning between the wheel and the road. Be careful to avoid road hazards and reduce your speed, especially if your vehicle is equipped with low-profile tires. Performance tires are not recommended for driving in ice and snow conditions.

Wheel and tire specifications are subject to change. Get the latest information on BMW standard and optional features, packages and technical specifications. Visit bmwusa.com, select the BMW model of your choice, and click on "Features & Specs."

Every seat, every vantage point, every view from the BMW X1 is an inspiring experience. After all, the X1 is heir to the same premium heritage as every other BMW model. Small wonder, then, that the X1's appointments display a modern sophistication that catch and reward the eye.

It starts with a choice of upholstery, paired to a wide variety of trims, such as Light Finesse Wood, High-Gloss Copper or Dark Crosshatch Aluminum, making each interior a customized work of art.

Occupants can relax in perfect comfort, thanks to the intelligently and ergonomically designed cabin. A variety of cupholders, trays and large door compartments means there's no shortage of storage for personal items. Heated front seats are a boon on chilly mornings; for the driver, the heated steering wheel keeps cold hands from being uncomfortable. On the dashboard, the climate and radio controls offer quick and easy selections for near-instant gratification.

A HIGH-PERFORMANCE PERSONAL STATEMENT

There's far more than just one way to experience the dynamic exhilaration of the BMW X1. With a kaleidoscope of paint, upholstery and trim combinations, no two are alike.



Dynamic: Sport Line and M Sport Line

Inspired by BMW's track heritage, the Sport Line and M Sport Line reveal the X1's racier side, turbocharging its look and attitude. The M Sport Line adds serious performance enhancements for an even more dynamic driving experience.





BMW ConnectedDrive
In touch with your world.

**EVEN IN MOTION, THE X1 GIVES YOU
ACCESS TO THE OUTSIDE WORLD.**

►► **“Connected” isn’t merely the latest buzzword. It’s a BMW mandate, made possible through extensive research and innovative technology. More than just the powerful engines, near-perfect 50/50 weight distribution or the stiff yet lightweight suspension that connects you to the road, BMW wants to keep you connected to your life, no matter where you roam.**

The BMW ConnectedDrive suite of features provides a smooth transition from your life at home or the office, to the one you have in the X1. Advanced Voice command programs let you take notes, dictate messages and send emails – all hands-free. Update your To-do List using your iDrive system and your Bluetooth® linked smartphone. BMW Apps take this connectivity to a whole new level: a slew of music-on-demand options give you nearly unlimited listening choices, from opera and rock, to comedy and talk radio, and everything in between. Stay in touch with social media and post prewritten messages on Facebook® or Twitter.® Discover a great new restaurant in the area and get directions to and from – even if the last leg of the journey is on foot. New BMW Apps are constantly tested and evaluated, providing an expanding roster of

suitable apps to enhance your driving experience. Simply visit the Apple® App Store and install the free BMW Connected App on your iPhone.®

Of course, enjoying greater convenience should never mean sacrificing safety, but adding to it. The X1’s extensive arsenal of active and passive safety features include Automatic high beams, a feature that optimally illuminates dark streets and automatically dims high-beam lights in the presence of oncoming traffic. Should the unforeseeable happen, you can feel at ease knowing that your vehicle’s BMW Assist™ system has automatically initiated a call to the BMW Assist center. Advanced sensors in the vehicle can detect the location and severity of the impact and the possibility of injuries. It then relays this information directly to the BMW Assist response specialists, who dispatch appropriate rescue services.

This and other BMW ConnectedDrive features add to the X1’s safety quotient and help you arrive at your destination more relaxed on every trip.

Get the latest information on BMW standard and optional features, packages and technical specifications. Visit bmwusa.com, select the BMW model of your choice, and click on “Features & Specs.”



Always be prepared: the X1 gives you the tools to address your personal or professional life at a moment’s notice, while still keeping your mind – and your eyes – on the road ahead.



A LEGEND ALREADY IN THE MAKING.

The X1 shares its DNA with other incredible BMW vehicles, all of which are part of EfficientDynamics: BMW's method of constructing a vehicle that maximizes the driver and passenger experience while reducing fuel consumption and emissions. This means developing each component so that it's doing its job as well as possible. And ensuring that the whole is more than merely the sum of its parts. As with any BMW model, the X1 gives you more than what you're looking for, and can surprise even the most critical daily drivers. It's all by design.

►► As the first premium sub-compact SUV-style vehicle, the X1 has many expectations to live up to. As a BMW vehicle, it's already well on its way. After all, the same potent mix of high-performance power, cutting-edge technology and matchless luxury is in every BMW vehicle.



BMW EfficientDynamics
Less emissions. More driving pleasure.



PERPETUALLY IN MOTION: ADVANCED BMW TECHNOLOGY.

► Think of the BMW X1 as a snapshot of BMW's progress: there's no single component that defines it. That's because our designers, scientists and engineers never stop developing new technologies and new features, with the goal of raising the bar throughout the industry. BMW has had more than its share of "firsts" – a trend we plan on continuing well into the future.

More efficient engines. More intelligent driving enhancements. More luxurious, ergonomic interiors. And more compelling exterior designs. At BMW, we constantly strive to discover new and exciting ways to deliver on our promise: creating The Ultimate Driving Machine.® The BMW X1 is an exhilarating iteration of that journey – one that you'll be just as thrilled to experience with us.





BMW ConnectedDrive In touch with your world.

Every day, our world is becoming increasingly networked. Many BMW drivers, however, are better connected than the rest, obtaining information on the road, communicating by phone or email, and always updated on the latest events. BMW ConnectedDrive encompasses all these services, including traffic features that allow BMW vehicles and their occupants to network with the outside world.

bmwusa.com/connecteddrive



BMW CONNECTED DRIVE: CONVENIENCE, INFOTAINMENT AND SAFETY TECHNOLOGIES MEET IN ONE SUITE.

With BMW ConnectedDrive you stay in touch, no matter where you go. Its advanced communications and entertainment features create a network between driver, vehicle and environment, at any time and wherever you are. The following pages present special highlights in the areas of convenience, infotainment and safety. For a comprehensive overview of the BMW ConnectedDrive range, see bmwusa.com/connecteddrive.

Convenience. These BMW ConnectedDrive innovations offer service-oriented functions, so you can always relax in your BMW.



Rear-view Camera shows on the Control Display the area behind your vehicle. Working with Park Distance Control, interactive guidelines indicate if a parking space can accommodate the vehicle, and display parking trajectories and turn angles. Engaging reverse gear activates the Rear-view Camera.



Park Distance Control (PDC) uses ultrasonic sensors in the front and rear bumpers to help you judge the distance to other cars and unseen objects when parking. The beeping becomes faster as your bumper approaches the object, turning into a constant tone when the distance is less than 12 inches.



Comfort Access system offers convenient keyless access to your vehicle. By carrying the remote key in a pocket or purse, you can unlock or lock the vehicle by touching the door handle or trunk lid. Start or shut off the engine simply by pressing the Start/Stop button. This system also includes vicinity lighting in the exterior door handles.

Get the latest information on BMW standard and optional features, packages and technical specifications. Visit bmwusa.com, select the BMW model of your choice, and click on "Features & Specs."

STAY TOTALLY IN TOUCH WHEREVER YOU GO – WITH BMW CONNECTED DRIVE.

Whether you're far from home or just in the next town, BMW Assist™ offers convenience and peace of mind. There are new ConnectedDrive features that extend BMW's leadership in wireless communications. Marvel at an extensive array of new Mobile Office functions. Get a visual image of your callers. With BMW Assist, you enjoy all this – and more.



BMW Apps lets you access Social Networks, music PlugIn and Video Playback through your iPhone®, and see them on the Display screen.¹ Tune in to **Web radio** and search for stations from around the globe by name, location or genre. You can also store your favorite stations, find similar stations, display station information, and change the quality of the audio. Your favorite entries are stored on your iPhone, so you can take them with you from one vehicle to another.

Please note: • A broadband data link is required. The costs for this (e.g., data roaming) are regulated by the customer agreement with the mobile phone service provider.
 • Not all features available while vehicle is in motion; see dealer for details.
 • Web radio audio quality depends on the bit rate of the station, and data reception depends on your cell service. Data transfer comes over the iPhone.

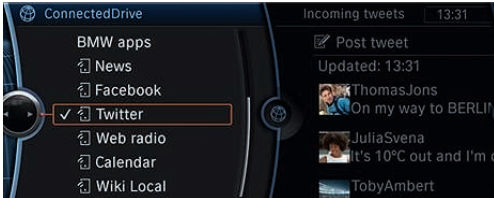

BMW Connected App, a suite of integrated web-connected features, can read aloud your Facebook® and Twitter® feeds, and lets you send prewritten tweets with a single click. **Wiki Local**, a geographically based feature, finds and reads aloud Wikipedia® articles relevant to the place you select – while **Wiki Tourguide** takes you through a list of articles about nearby points of interest, prioritized by distance from your vehicle's current location. **The Last Mile Navigation and Vehicle Finder**, also included in the BMW Connected App suite, provides walking directions to your destination after you've parked – and directions back to your car later.

Please note: Local information may not be available in all areas.

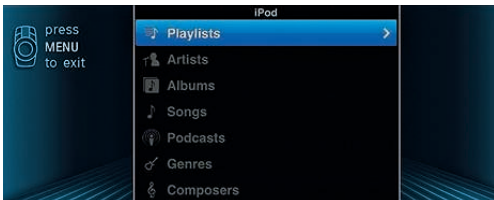

When you select **PlugIn** from the BMW Apps menu, the iPhone exports a typical iPod® look and control to your BMW through the video connection.¹ You can then search for your favorite music by playlist, artist, album, song, genre or composer, just as you would on your iPhone.

Please note: The BMW Connected App must be installed on your iPhone for the PlugIn to connect.

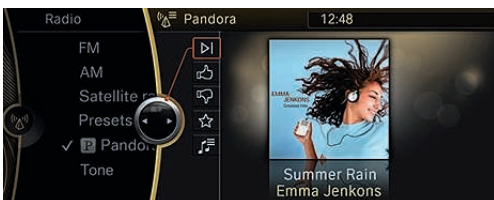

Part of BMW Apps, **Pandora Radio** is an innovative streaming audio service that delivers personalized music selections right to your BMW.¹ Create new stations and tailor your listening experience by rating songs with either a thumbs-up or thumbs-down. Even while listening, you can stay in touch: your BMW can still receive calls through Bluetooth® without missing a beat.

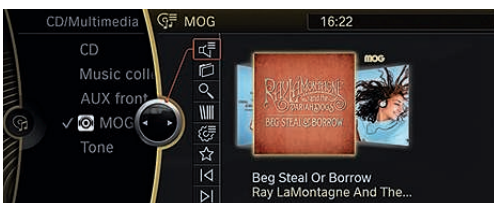

Enjoy the instant gratification of music on-demand in your BMW, thanks to **MOG**® – another part of BMW Apps. Browse, search and play any of 11 million songs in the MOG music library. Subscribing to MOG's **Primo** service allows you to take advantage of the seamless integration of MOG's mobile app.

¹ Requires BMW Apps option and an iPhone.

Get the latest information on BMW standard and optional features, packages and technical specifications. Visit bmwusa.com, select the BMW model of your choice, and click on "Features & Specs."



Use the time you spend in your vehicle even more effectively with BMW's **Mobile Office** feature.² For example, text messages and emails can be transferred from your Bluetooth paired phone directly to the vehicle's iDrive Display and can be read back to you using Text-to-speech functionality and the vehicle's audio system. Thanks to Bluetooth audio streaming, you can enjoy wireless playback of your music files; your personal audio library can even be accessed via the iDrive Controller.

² Not all mobile phones are compatible with Mobile Office, and some compatible phones support a limited number of Mobile Office functions. For the complete list of compatible mobile phones and the details regarding which Mobile Office functions are supported by each phone, please visit bmwusa.com/bluetooth.



MyInfo allows you to send business locations and street addresses to your BMW from Google Maps™. Destinations and phone numbers can be accessed and exported to your Navigation system for immediate route guidance.



BMW Online allows online access to up-to-date fuel prices and gas station locations; the latest weather forecasts, advisories and warnings; Dow Jones, S&P 500 and NASDAQ indices; and the powerful reach of the Google Maps database – all delivered on the Control Display inside your vehicle. Access news headlines and have them read aloud via Text-to-speech technology. "Send to Mail" pinpoints your current location and planned destination, and allows you to send the information to any smartphone or email account. Then it's just a quick hyperlink to Google Maps for your friends and family to see where you are and where you're going.



Enhanced functions for the iPod and USB adapter add to the ease and pleasure of using your iPod or iPhone. Want to know which CD that song comes from? The album cover is shown on your Display screen. Don't purchase additional cables – your iPod or iPhone's original USB cable connects to your BMW's USB port. Another rare feature: with BMW Assist and Bluetooth audio streaming, you can wirelessly play music through the BMW audio system from any Bluetooth compatible music player or mobile phone, from anywhere in your vehicle. In fact, the audio library appears on the Display screen, where you can use the iDrive Controller knob to make your selection.



BMW Assist gives you peace of mind knowing that a friendly response specialist is there to help you 24/7, at the touch of a button. The **Safety Plan** includes Advanced Automatic Collision Notification, Emergency Request (SOS), TeleService, Enhanced Roadside Assistance, Door Unlock, Stolen Vehicle Recovery, Customer Relations and MyInfo. The **Convenience Plan** adds personalized Directions, Traffic and Weather reports, BMW Online and Concierge services for restaurant and hotel recommendations, with the destination address and phone number sent to your BMW. Make up to four operator-assisted calls per year with Critical Calling if your mobile phone is not available or its battery is discharged.

BMW EfficientDynamics

Less emissions. More driving pleasure.

BMW was one of the first automotive manufacturers to pursue the goal of efficient driving technologies, as part of a multi-award-winning sustainability strategy. BMW EfficientDynamics represents an acclaimed standard package of innovative technologies that reduce fuel consumption and emissions, while simultaneously enhancing dynamic performance. Since 1995 BMW has been able to reduce the CO₂ emissions of its entire fleet by approximately 30 percent and intends to achieve a further 25 percent reduction by 2020.



BMW EFFICIENT DYNAMICS – MAKING A LITTLE GO A LONG WAY.

Different paths to the same destination: unmistakable BMW driving pleasure. Under the umbrella of the BMW EfficientDynamics project, BMW is continuously developing innovative systems that will bring us closer to the goal of emissions-free mobility in the long term. This BMW program for more driving pleasure is based on several pillars:

Eco-friendly technology. Developing more efficient vehicles powered by conventional diesel and gasoline engines is a continuing challenge. BMW's comprehensive technology directive enables the reduction of fuel consumption and emissions while increasing power output and driving enjoyment. These advances are based on innovations such as BMW TwinPower Turbo technology, Brake Energy Regeneration, Air Curtain front apron design, and many others.

BMW ActiveHybrid. BMW's impressive hybrid production models – the BMW ActiveHybrid 7, BMW ActiveHybrid 5 and BMW ActiveHybrid 3 – all combine outstanding efficiency with superlative dynamic ability.

BMW ActiveE. Since 2011, there has been a new form of dynamism on the roads: the all-electric BMW ActiveE. It is manufactured in a small production run, as part of a pilot project. In this way, BMW is preparing the way for the emissions-free mobility of the future.

BMW hydrogen and electric. BMW continues its research into alternative drive concepts for the future, such as hydrogen drive. The BMW i brand launches completely new concepts for sustainable mobility in an urban environment, such as the BMW i3 and the BMW i8. Key features of these vehicle concepts include the use of lightweight materials such as carbon-fiber-reinforced plastic (CFRP), electric drive systems, powerful battery technology and eco-friendly production methods. BMW EfficientDynamics technologies are also an important part of BMW i vehicles.

bmw-i.com

THE BMW X1'S EFFICIENT DYNAMICS INITIATIVE AT A GLANCE.

BMW TwinPower Turbo technology.

A twin-scroll turbocharger, Valvetronic steplessly variable valve control and high-precision direct injection combine to significantly reduce fuel consumption and emissions, while also greatly improving acceleration. Thanks to the twin-scroll turbocharger, the engine is incredibly responsive and has plenty of torque, even at low engine speeds.

Valvetronic.

BMW's Valvetronic valve control system improves engine response and refinement, while also helping to reduce fuel consumption. The system helps the engine "breathe" better by providing fully variable lift adjustment of the inlet valves.

Auto Start-Stop function.

Even when idling, such as at a stop sign, an engine burns fuel. BMW's Auto Start-Stop function enhances fuel efficiency by switching off the engine. (The intelligent electronics system first checks the battery charge level and calculates if other electric systems, like the heated rear window, need more energy.) Once the brake pedal is released, the engine starts up again almost instantly. A Start-Stop signal in the Display indicates the function is active.

High-precision direct injection.

In this latest-generation direct fuel-injection system, the piezo injectors are positioned very close to the spark plugs. They inject fuel at high pressure, with extreme precision, for very efficient combustion.

ECO PRO mode.

Driving in ECO PRO mode helps customers achieve fuel savings of up to 20 percent, depending on their individual style of driving. This mode optimizes accelerator and transmission response, as well as shift points, and intelligently adapts the heating/air conditioning strategy. ECO PRO tips help the driver drive even more efficiently. The bonus range shown by the on-board computer indicates how many additional miles the driver has gained thanks to the increased efficiency in ECO PRO mode since the last fill-up.

Brake Energy Regeneration.

To supply a battery with electrical energy, the generator (alternator) is usually driven using engine power, which requires fuel. With Brake Energy Regeneration, the alternator generates electricity only when you take your foot off the accelerator. Kinetic energy that was previously unharnessed is transformed into electrical energy, which is then fed into the battery. In this way, electricity is generated without consuming fuel.

Not all BMW EfficientDynamics features are available on all models. Please see your authorized BMW center for details.

TWO ENGINES THAT MAKE ALL THE RIGHT MOVES.

High-revving power and responsiveness are characteristics of every BMW engine. Naturally, the BMW TwinPower Turbo engines available for the BMW X1 follow the BMW EfficientDynamics philosophy: to combine maximum performance with maximum efficiency, minimizing both fuel consumption and CO₂ emissions. Whichever engine you choose, maximum driving pleasure combined with superb efficiency is the result.

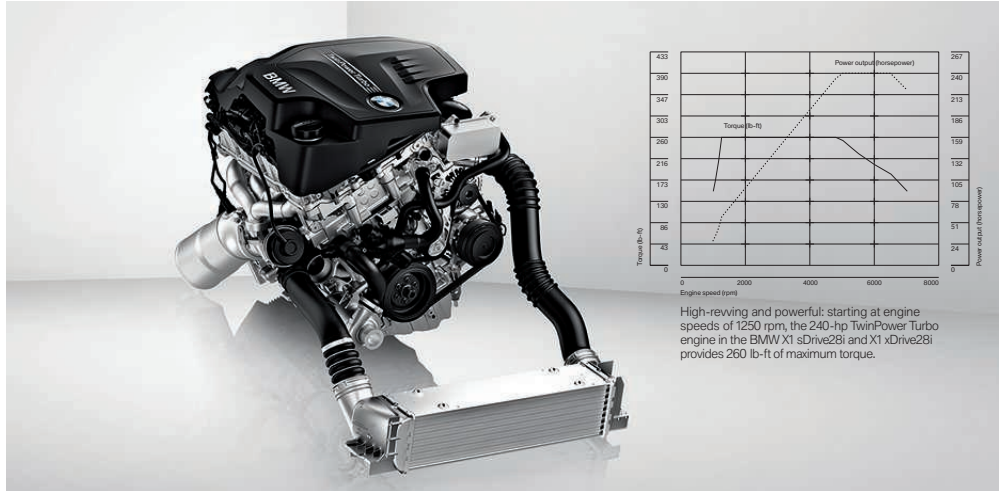

BMW X1 sDrive28i and X1 xDrive28i.

Small is now the big idea in engines – namely, BMW's mighty inline four-cylinder TwinPower Turbo. Displacing just 2.0 liters, this 240-hp marvel generates 260 lb-ft of torque at just 1250 rpm, for potent thrust that kicks in right from the start and continues all the way up to 4800 rpm. Lightweight and smooth-running, this award-winning engine is modeled on BMW's current six-cylinder inline engine with BMW TwinPower Turbo technology, which is the benchmark in its class for dynamic power delivery and impressive efficiency. The dynamic performance of the inline four-cylinder engine is equaled by its spectacular fuel efficiency, taking you further on every gallon of gas.

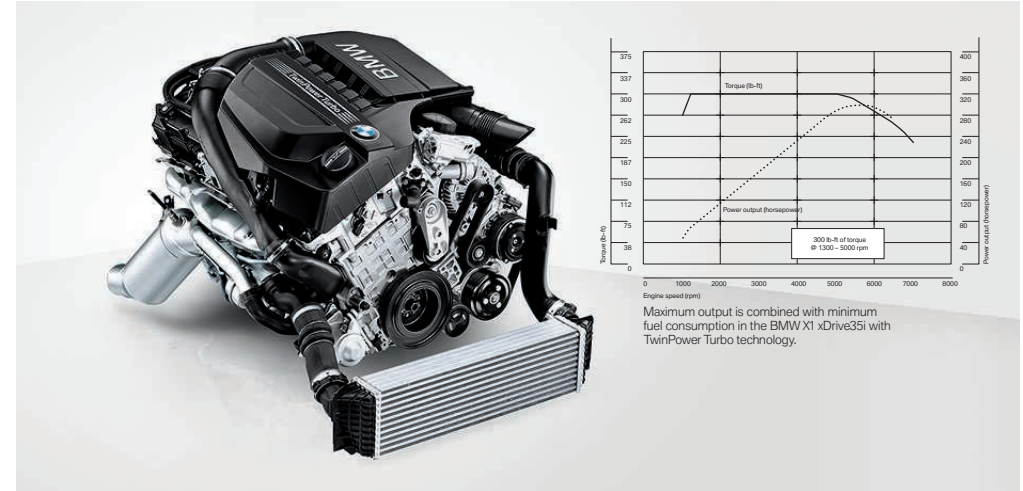

BMW X1 xDrive35i.

BMW's multi-award-winning, 3.0-liter TwinPower Turbo inline six-cylinder engine combines a twin-scroll turbocharger with variable valve control (Double-VANOS and Valvetronic, which helps the engine "breathe" better) and high-precision direct injection. The result: turbo lag is virtually eliminated, while posting one of the most fuel-efficient ratings in its class. In just 5.3 seconds,¹ the X1 xDrive35i is rushing past 60 mph, thanks to a maximum output of 300 hp at 5800 rpm. Adding to the fun, 300 lb-ft of peak torque begins at just 1300 rpm and doesn't end until 5000 rpm.

¹ BMW AG test results. See page 62 for detailed technical data. BMW urges you to obey all posted speed laws and always wear safety belts.

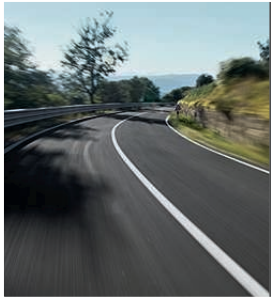

Pure driving dynamics – it's a quality embodied by every single BMW without exception. And the technical basis for this thrilling driving experience lies in the suspension. It ensures optimal contact with the road surface and ideal road-holding in every situation – the result of near-perfect 50/50 weight distribution and an array of seamlessly combined innovative components. BMW engineers are continually re-inventing and refining those classic BMW driving dynamics to ensure that every BMW chassis puts the driver in direct contact with the vehicle and inspires a passion for sporty driving – while also providing the highest levels of safety and comfort.



THE FEELING OF DRIVING THE BMW X1 IS SIMPLY INCREDIBLE. LIKE THE TECHNOLOGY BEHIND IT.

The BMW X1 can be equipped with a whole host of innovative technologies to help you get the most out of each drive. Many of these systems are intelligently networked with each other, maximizing your active safety quotient – and your driving pleasure.

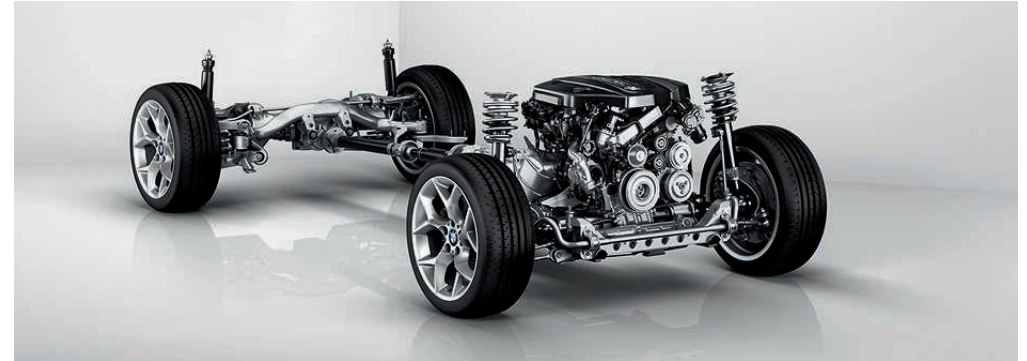

Electric power steering. Unlike conventional, hydraulic steering systems, electric power steering only draws power during actual steering movements. While driving on major highways where a minimal amount of steering movement is required, the electric motor remains inactive.

Servotronic vehicle-speed-sensitive power steering adjusts the amount of steering support based on your current speed – not engine speed. It offers more assistance at lower speeds, such as when parking, and decreases assistance at higher speeds for more stability and control.

BMW sDrive rear-wheel drive. BMW's renowned driving technology provides inspired vehicle agility and maneuverability. Rear-wheel drive enables an ideal distribution of weight over the entire chassis suspension, delivering power and traction more precisely onto the pavement.

BMW xDrive intelligent all-wheel drive. BMW designed xDrive with a rear-wheel bias for surefooted grip on slick roads without sacrificing rear-wheel-drive road feel. Within milliseconds of sensing wheelslip, the xDrive all-wheel-drive system can send power to the wheels with the greatest grip, offering maximum available traction and superior handling on all surfaces.

8-speed STEPTRONIC automatic transmission. The finely graded gear shifts of the 8-speed STEPTRONIC automatic transmission produce greater engine efficiency at every speed. This helps to reduce fuel consumption and ensures more comfortable gear changes.

Sport suspension. This suspension, which is achieved without lowering the chassis, features more firmly tuned springs and dampers, which improves the BMW's roadholding further and enables an even more dynamic driving style.

Performance Control. This system works together with xDrive intelligent all-wheel drive to improve handling in turns by dynamically intervening in specific engine and braking processes. Performance Control optimizes the management of engine power during turns by applying the brake slightly to the inside wheel while simultaneously increasing power to the outside wheel.

Get the latest information on BMW standard and optional features, packages and technical specifications. Visit bmwusa.com, select the BMW model of your choice, and click on "Features & Specs."

HIGH-TECH BODYGUARDS: ACTIVE AND PASSIVE SAFETY.

The X1 is designed with BMW's full range of standard state-of-the-art active and passive safety technologies. Active safety features, such as Xenon Adaptive Headlights, powerful engines and large brakes, help you see and respond to potentially dangerous situations. Should an accident prove unavoidable, passive safety features, such as airbags, are designed to help protect you and your passengers. After a severe impact, a host of features spring into action: the doors automatically unlock, headlights and taillights flash, the starter cable is disconnected from the battery and the fuel supply is cut off. In vehicles with BMW Assist,TM should any airbags deploy, response specialists are automatically alerted and notified of your location.

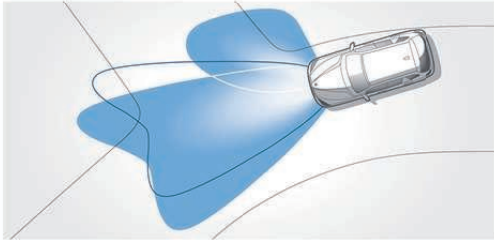

Adaptive Headlights with LED Corona headlight-rings automatically swivel to follow the curves of the road, enhancing visibility when driving at night. The system uses data from on-board sensors and the steering wheel angle to determine the vehicle's direction. The outer headlights then swivel accordingly, up to 15 degrees left or right. An auto-leveling feature adjusts the headlight beam's trajectory for varying passenger and cargo loads.

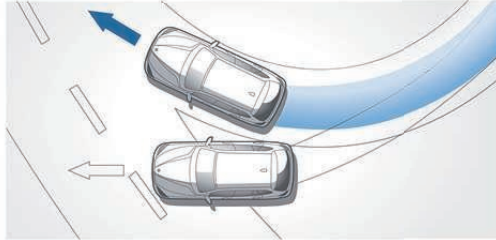

Dynamic Stability Control (DSC). This system provides remarkable tenacity on slippery road surfaces. If it senses over- or understeer, it modulates engine power and can apply brakes individually to help keep the vehicle under control and going in the intended direction. Start-off Assistant, a feature of DSC, prevents the vehicle from rolling backward on a hill for approximately 2 seconds after taking your foot off the brake. The system also includes Brake Fade Compensation, which lets you use the same amount of pedal force, even when the brakes are heated; Brake Stand-by, which pre-tenses the brakes for quicker action if you suddenly remove your foot from the accelerator pedal; and Brake Drying, which periodically brings the brake pads into contact with the rotors to eliminate accumulated moisture when it rains.

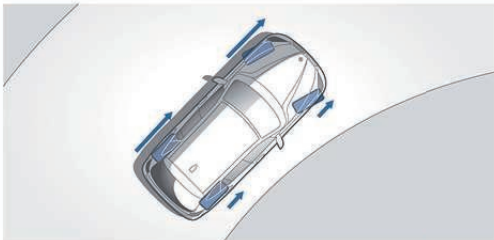

Performance Control, in BMW X1 models equipped with xDrive intelligent all-wheel drive, creates an even more agile and dynamic driving experience by controlling each wheel individually in a curve. It can vary engine power and, if necessary, apply braking force to give the outer wheels greater drive power than the inner wheels, resulting in maximum traction, precision and stability.

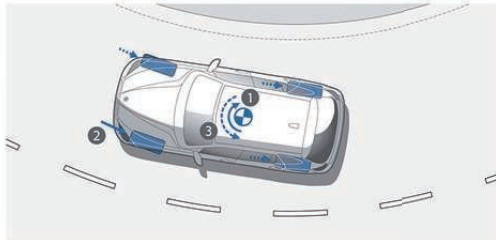

Cornering Brake Control (CBC) increases your vehicle's stability by proportioning the braking force while turning. When you brake in a turn, pressure comes off the rear wheels, which causes your vehicle to swerve inward (oversteer) (1). Cornering Brake Control counteracts this action by asymmetrically adjusting brake pressure (2), creating stabilizing counter-torque (3) independently of the ABS system.

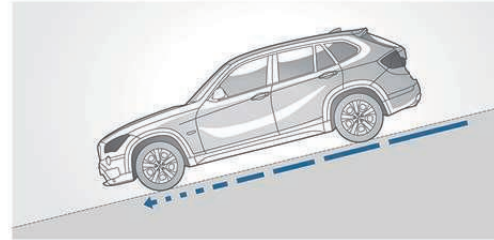

Hill Descent Control (HDC), included in the X1 xDrive28i and the X1 xDrive35i, helps the vehicle drive down steep hills without having to "ride the brake." By pressing the HDC button, the system keeps the vehicle's speed under control automatically.

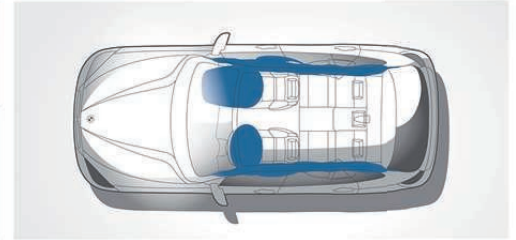

Airbags, designed to deploy only as needed in the event of a collision, are an integral part of the passive safety system in the BMW X1. Six airbags are installed for occupant protection: one front- and side-impact airbag each for the driver and front passenger, and continuous Head Protection System (HPS) airbags at the sides of the front and rear cabin to help protect all occupants.

Please note: These pictures of airbags are for illustrative purposes only. Depending upon the type of accident, none, some or all may deploy.

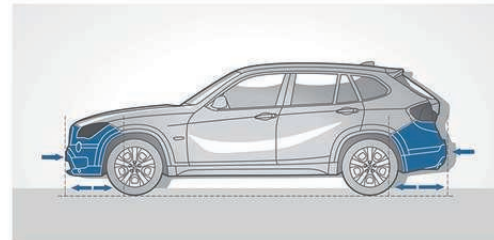

Compressible "crush tubes" and impact-absorbing bumpers front and rear help absorb the force of impact in collisions up to 9 mph, helping to minimize damage to the vehicle's body and simplifying repairs. Only at higher impact speeds do structural supports begin to deform, dissipating impact energy to help protect occupants.

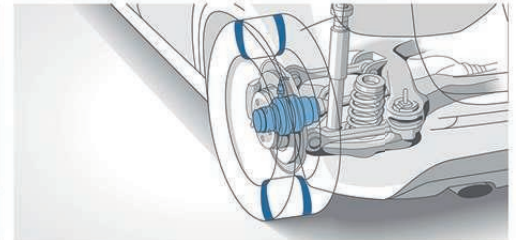

Run-flat tires. Thanks to reinforced sidewalls, run-flat tires maintain their shape and rim position even after suffering a complete loss of tire pressure. They allow you to continue driving at a reduced speed until you reach a safe area to change a tire or wait for Roadside Assistance. The Tire Pressure Monitor alerts you when there is a drop in tire pressure; if the loss is severe, an acoustic warning is triggered.

Please see Owner's Manual for more information detailing allotted miles to travel and load weight rules for run-flat tires.

THE BMW X1.



Sit back in the driver-oriented cockpit where instrumentation and controls are all within easy, intuitive sight and reach. The leather-wrapped multifunction steering wheel provides a firm grip and gives you access to handy features without taking

your eyes off the road or your hands off the wheel, while 8-way adjustable front seats let you set the perfect driving position.

Leather upholstery: Leather on all seating surfaces; other components may be Leather or Leatherette.



The dramatic juxtaposition of Mineral White Metallic exterior paint against a Black Nevada Leather-upholstered interior is heightened by Silver Matte trim. A practical array of cupholders and storage spaces, front and rear, makes every trip more pleasurable.



Star Spoke (Style 317) 17 x 7.5 light alloy wheels with 225/50 run-flat¹ all-season tires.²



Star Spoke (Style 320) 18 x 8.0 light alloy wheels with 225/45 run-flat¹ all-season tires.²



V Spoke (Style 318) 17 x 7.5 light alloy wheels with 225/50 run-flat¹ all-season tires.²

¹ Run-flat tires do not come equipped with a spare tire and wheel.

² Driving over rough or damaged road surfaces, as well as debris, curbs and other obstacles, can cause serious damage to wheels, tires and suspension parts. This is more likely to occur with low-profile tires, which provide less cushioning between the wheel and the road. Be careful to avoid road hazards and reduce your speed, especially if your vehicle is equipped with low-profile tires.

Wheel and tire specifications are subject to change. Get the latest information on BMW standard and optional features, packages and technical specifications. Visit bmwusa.com, select the BMW model of your choice, and click on "Features & Specs."



The BMW X1 sDrive28i in Mineral White Metallic exterior paint finish.

THE BMW X1 WITH xLINE.

Interior equipment:

- Seats in:
 - Beige or Black Leatherette
 - Nevada Leather with "X" embossed on the outer headrests, in a choice of:
 - Oyster with Orange/Black contrast piping and Savanna Beige-trim floor mats
 - Black with Gray/Brown contrast piping and Everest Gray-trim floor mats
 - Terra with Gray/Petrol contrast piping and Everest Gray-trim floor mats
- High-Gloss Dark Copper or Finesline Bay Matte Wood interior trim
- Aluminum door-sill finishers with the "BMW xLine" logo

Exterior equipment:

- Y Spoke (Style 322) 18 x 8.0 light alloy wheels and 225/45 run-flat¹ all-season tires.²
- ¹ Run-flat tires do not come equipped with a spare tire and wheel.
² Driving over rough or damaged road surfaces, as well as debris, curbs and other obstacles, can cause serious damage to wheels, tires and suspension parts. This is more likely to occur with low-profile tires, which provide less cushioning between the wheel and the road. Be careful to avoid road hazards and reduce your speed, especially if your vehicle is equipped with low-profile tires.

Wheel and tire specifications are subject to change. Get the latest information on BMW standard and optional features, packages and technical specifications. Visit bmwusa.com, select the BMW model of your choice, and click on "Features & Specs."

Leather upholstery: Leather on all seating surfaces; other components may be Leather or Leatherette.



Nevada Leather upholstery in exclusive Terra with Gray/Petrol piping adds an earthy elegance to the interior.



Aluminum door-sill finishers sporting the "BMW xLine" logo welcome you into the cabin.



The X1 xLine features **Y Spoke (Style 322)** 18 x 8.0 light alloy wheels and **225/45 run-flat¹ all-season tires.²**

xLine upholstery



LUTW Terra Nevada Leather with Gray/Petrol piping



KCB4 Beige Leatherette



4L3 High-Gloss Dark Copper



LUG1 Black Nevada Leather with Gray/Brown piping



KCSW Black Leatherette



4EB Finesline Bay Matte Wood



LUDP Oyster Nevada Leather with Orange/Black piping



The BMW X1 xDrive28i with xLine in Midnight Blue Metallic exterior paint finish.

THE BMW X1 WITH SPORT LINE.

Interior equipment:

- Seats in:
 - Black Leatherette
 - Black Nevada Leather with Gray/Red contrast piping
 - Coral Red Nevada Leather with Gray/Black contrast piping
- Front sport seats
- Velour floor mats with Coral Red trim
- High-Gloss Black or Brushed Aluminum interior trim
- Aluminum door-sill finishers with the "BMW Sport" logo
- Leather-wrapped multi-function sport steering wheel with red contrast stitching
- Leather-wrapped multi-function sport steering wheel with red contrast stitching and steering wheel-mounted shift paddles

Exterior equipment:

- Double Spoke (Style 421) 18 x 8.0 light alloy wheels and 225/45 run-flat¹ all-season tires²
- Exterior side-view mirror caps in black
- Black chrome-plated tailpipe

¹ Run-flat tires do not come equipped with a spare tire and wheel.
² Driving over rough or damaged road surfaces, as well as debris, curbs and other obstacles, can cause serious damage to wheels, tires and suspension parts. This is more likely to occur with low-profile tires, which provide less cushioning between the wheel and the road. Be careful to avoid road hazards and reduce your speed, especially if your vehicle is equipped with low-profile tires.

Wheel and tire specifications are subject to change. Get the latest information on BMW standard and optional features, packages and technical specifications. Visit bmwusa.com, select the BMW model of your choice, and click on "Features & Specs."

Leather upholstery: Leather on all seating surfaces; other components may be Leather or Leatherette.



Aluminum door-sill finishers with the "BMW Sport Line" logo sets the tone for the sporty interior.



Driver and front passenger sport seats offer exceptional support during spirited driving maneuvers. Rendered in Coral Red Nevada Leather with Gray/Black piping and red contrast stitching, they evoke classic motorsport design.

Double Spoke (Style 421) 18 x 8.0 light alloy wheels and 225/45 **run-flat¹ all-season tires.²**

Sport Line upholstery



LUTZ Coral Red Nevada Leather with Gray/Black piping



KCSW Black Leatherette



4B9 Brushed Aluminum



LUG9 Black Nevada Leather with Gray/Red piping



4AT High-Gloss Black



The BMW X1 xDrive35i with Sport Line in Glacier Silver Metallic exterior paint finish.

THE BMW X1 WITH M SPORT LINE.

Interior equipment:

- Seats in:
 - Beige or Black Leatherette
 - Sand Beige or Black Nevada Leather
 - Coral Red Nevada Leather with Gray/Black piping
- Front sport seats
- Aluminum door-sill finishers with the "M" logo
- Dark Crosshatch Aluminum or Light Finesline Wood interior trim
- M footrest
- Anthracite headliner
- Leather-wrapped multi-function M sport steering wheel or Leather-wrapped multi-function M sport steering wheel with steering wheel-mounted shift paddles

Exterior equipment:

- Double Spoke (Style 355M) 18 x 8.0 front, 18 x 9.0 rear light alloy wheels with 225/45 front, 255/40 rear run-flat¹ performance tires.²
- Double Spoke (Style 225M) 19 x 8.0 front, 19 x 9.0 rear light alloy wheels with 225/35 front, 255/30 rear run-flat¹ performance tires.²
- Aerodynamic kit (front and rear bumpers, side skirts)
- Shadowline trim
- High-gloss roof rails
- Sport suspension
- Performance Control
- Increased top-speed limiter

Leather upholstery: Leather on all seating surfaces; other components may be Leather or Leatherette.

¹ Run-flat tires do not come equipped with a spare tire and wheel.

² Driving over rough or damaged road surfaces, as well as debris, curbs and other obstacles, can cause serious damage to wheels, tires and suspension parts. This is more likely to occur with low-profile tires, which provide less cushioning between the wheel and the road. Be careful to avoid road hazards and reduce your speed, especially if your vehicle is equipped with low-profile tires. Performance tires are not recommended for driving in snow and ice.

Wheel and tire specifications are subject to change. Get the latest information on BMW standard and optional features, packages and technical specifications. Visit bmwusa.com, select the BMW model of your choice, and click on "Features & Specs."



M door sill finishers with chrome insets and the "M" logo are your call to action.



Outside, Le Mans Blue Metallic paint, exclusive to the M Sport Line, makes an eye-catching statement, while an Aerodynamic kit, M-style light alloy wheels, shadowline trim and high-gloss roof rails accentuate the X1's athletic stance. Inside, the Black Nevada Leather interior spells serious performance and Dark Crosshatch Aluminum interior trim adds to the allure. Specially bolstered front sport seats hold you firmly during spirited driving maneuvers that take advantage of the taut sport suspension.

Double Spoke (Style 355M)
18 x 8.0 front, 18 x 9.0 rear light alloy wheels with 225/45 front, 255/40 rear run-flat¹ performance tires.²

Double Spoke (Style 225M)
19 x 8.0 front, 19 x 9.0 rear light alloy wheels with 225/35 front, 255/30 rear run-flat¹ performance tires.²



Exterior colors.

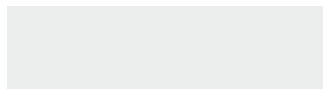

300 Alpine White Non-metallic



668 Jet Black Non-metallic



A96 Mineral White Metallic



A72 Cashmere Silver Metallic



B38 Midnight Blue Metallic



B44 Valencia Orange Metallic



B39 Mineral Gray Metallic



B06 Sparkling Bronze Metallic



A76 Deep Sea Blue Metallic



B09 Marrakesh Brown Metallic



A83 Glacier Silver Metallic



475 Black Sapphire Metallic



381 Le Mans Blue Metallic

Interior colors.



Black



Beige

Upholstery colors and materials.

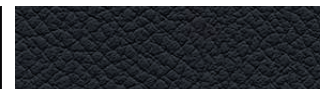

LUSW Black Nevada Leather



LUB4 Sand Beige Nevada Leather



KCSW Black Leatherette



KCB4 Beige Leatherette

Interior trims.



4CG Silver Matte



4B9 Brushed Aluminum



4CK Light Finition Wood



4AT High-Gloss Black



4L3 High-Gloss Dark Copper



4EB Finition Bay Matte Wood

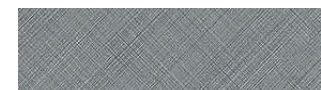

4MP Dark Crosshatch Aluminum

The pages in this section of the brochure show available colors and materials for the BMW X1. Use these samples to compare paint, upholstery, trim colors and combinations. Please note that these samples are representations; they are not exact reproductions. To see the actual colors, visit your authorized BMW center. They will be happy to show you original samples.

For details on the availability of standard and optional exterior paints and upholstery materials and colors, please visit bmwusa.com/byo.

Leather upholstery: Leather on all seating surfaces; other components may be Leather or Leatherette.

**Upholstery colors.
xLine.**



LUTW Terra Nevada Leather with Gray/Petrol piping



KCB4 Beige Leatherette



4L3 High-Gloss Dark Copper



LUG1 Black Nevada Leather with Gray/Brown piping



KCSW Black Leatherette



4EB FineLine Bay Matte Wood



LUDP Oyster Nevada Leather with Orange/Black piping

**Upholstery colors.
Sport Line.**



LUG9 Black Nevada Leather with Gray/Red piping



KCSW Black Leatherette



4AT High-Gloss Black



LUTZ Coral Red Nevada Leather with Gray/Black piping



4B9 Brushed Aluminum

**Interior trims.
xLine.**

**Interior trims.
Sport Line.**

Recommended color combinations.

	BMW upholstery colors																
	Basic		xLine				Sport Line		M Sport Line								
	Nevada Leather	Leatherette	Nevada Leather		Leatherette		Nevada Leather	Leatherette	Nevada Leather		Leatherette						
Upholstery materials																	
Upholstery colors	Black	Sand Beige	Black	Beige	Terra	Black	Oyster	Beige	Black	Black	Coral Red	Black	Black	Sand Beige	Coral Red	Black	Beige
Interior colors	Black	Beige	Black	Black	Black	Black	Black	Beige	Black	Black	Black	Black	Black	Beige	Black	Black	Black
Exterior colors																	
Alpine White Non-metallic	●	●	●	●	●	●	●	●	●	●	●	●	●	●	●	●	●
Jet Black Non-metallic	●	●	●	●	●	●	●	●	●	●	●	●	●	●	●	●	●
Mineral White Metallic	●	●	●	●	●	●	●	●	●	●	●	●	●	●	●	●	●
Cashmere Silver Metallic	●	●	●	●	●	●	●	●	●	●	●	●	●	●	●	●	●
Midnight Blue Metallic	●	●	●	●	●	●	●	●	●	●	●	●	●	●	●	●	●
Valencia Orange Metallic	●	●	●	●	●	●	●	●	●	●	●	●	●	●	●	●	●
Mineral Gray Metallic	●	●	●	●	●	●	●	●	●	●	●	●	●	●	●	●	●
Sparkling Bronze Metallic	●	●	●	●	●	●	●	●	●	●	●	●	●	●	●	●	●
Deep Sea Blue Metallic	●	●	●	●	●	●	●	●	●	●	●	●	●	●	●	●	●
Marrakesh Brown Metallic	●	●	●	●	●	●	●	●	●	●	●	●	●	●	●	●	●
Glacier Silver Metallic	●	●	●	●	●	●	●	●	●	●	●	●	●	●	●	●	●
Black Sapphire Metallic	●	●	●	●	●	●	●	●	●	●	●	●	●	●	●	●	●
Le Mans Blue Metallic	●	●	●	●	●	●	●	●	●	●	●	●	●	●	●	●	●
Interior trims																	
Silver Matte	●	●	●	●													
Brushed Aluminum										●	●	●					
Light FineLine Wood	●	●	●	●									●	●	●	●	●
High-Gloss Black																	
High-Gloss Dark Copper					●	●	●	●	●								
FineLine Bay Matte Wood					●	●	●	●	●								
Dark Crosshatch Aluminum													●	●	●	●	●
xLine interior trims																	
High-Gloss Dark Copper					●	●	●	●	●								
FineLine Bay Matte Wood					●	●	●	●	●								
Sport Line interior trims																	
High-Gloss Black											●	●	●				
Brushed Aluminum											●	●	●				
M Sport Line interior trims																	
Dark Crosshatch Aluminum													●	●	●	●	●
Light FineLine Wood													●	●	●	●	●

Leather upholstery: Leather on all seating surfaces; other components may be Leather or Leatherette.

For details on the availability of standard and optional exterior paints, upholstery materials and colors, and interior trims, please visit bmwusa.com/byo.

Equipment features and options.



Xenon low- and high-beam headlights illuminate the road ahead and to the side with brilliant clarity. An auto-leveling feature adjusts for varying passenger and cargo loads. LED **Corona headlight-rings** that circle both headlights and high beams also act separately as Daytime Running Lights and parking lights.

Xenon Adaptive Headlights optimize road illumination when entering a turn or corner, helping to enhance visibility when driving at night. Sensors continuously monitor the angle of the steering wheel to determine the direction in which your vehicle is heading. The outer headlights swivel accordingly, up to 15 degrees left or right.



Taillight cluster with taillight, brakelights and turn-signal indicators incorporate LED technology for greater visibility.
Adaptive Brakelights warn following vehicles by increasing in brightness when the intensity of your braking action is increased.



Halogen free-form foglights, built into the front air dam, enhance your margin of safety in poor visibility. Ellipsoid free-form technology provides for even light distribution on the road.



Power-adjustable, folding exterior side-view mirrors in body color feature integrated LED turn indicators. Automatic anti-glare function dims mirrors when reflecting bright lights, helping to eliminate glare when driving at night.



Automatic high beams switch between high and low beams according to oncoming traffic, traffic ahead, and the level of street lighting.



Rain sensor uses infrared light to measure the amount of rain. When the wipers are in the "intermittent" mode, the rain sensor automatically adjusts the windshield-wiping interval as needed.

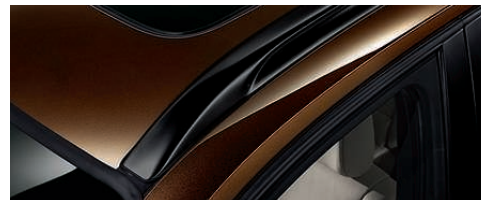

Black roof rails, cleanly integrated into the BMW X1 design, provide the foundation for BMW's (accessory) modular roof rack system, which allows the convenient, secure transport of luggage, bicycles, surfboards, etc.



Aluminum Satin roof rails give the X1 an elegant appearance – especially when equipped with the xLine.



High-Gloss roof rails, included with the M Sport Line, underscore the dynamic look of shadowline trim.



Panoramic moonroof features extra-large dual-glass panels to let the sun and stars shine in, whether it is open or closed. Easy-to-use features include a power slide and lift control, a comfort opening/closing function, and a power sunshade to shield passengers from excessive glare and heat.

Anthracite headliner complements the black moonroof trim and roof handles.



Chrome-line exterior trim adds the perfect finishing touch, especially on X1 models with the xLine. Chrome trim enhances the window recess finishers at the B-pillar panel, the rear window guide panel and specific mirror features.



Shadowline trim, included with the M Sport Line, covers the B-pillar trims, the window guide, the window recess finishers, the mirror base and mirror frame in high-gloss black.



Door lighting, included in Lighting Package, helps provide safe vehicle access in the dark, with lights in the door handles that radiate downward 20 seconds after unlocking doors.

Get the latest information on BMW standard and optional features, packages and technical specifications. Visit bmwusa.com, select the BMW model of your choice, and click on "Features & Specs."

Equipment features and options.



Star Spoke (Style 317) 17 x 7.5 light alloy wheels with 225/50 **run-flat**¹ **all-season tires.**²



V Spoke (Style 318) 17 x 7.5 light alloy wheels with 225/50 **run-flat**¹ **all-season tires.**²



Star Spoke (Style 320) 18 x 8.0 light alloy wheels with 225/45 **run-flat**¹ **all-season tires.**²



Double Spoke (Style 321) 18 x 8.0 light alloy wheels with 225/45 **run-flat**¹ **all-season tires.**²



Y Spoke (Style 322) 18 x 8.0 light alloy wheels with 225/45 **run-flat**¹ **all-season tires.**²



Honeycomb (Style 323) dual-color 18 x 8.0 front, 18 x 9.0 rear light alloy wheels with 225/45 front, 255/40 rear **run-flat**¹ **performance tires.**^{2,3}



Double Spoke (Style 421) dual-color 18 x 8.0 light alloy wheels with 225/45 **run-flat**¹ **all-season tires.**²



Double Spoke (Style 355M) 18 x 8.0 front, 18 x 9.0 rear light alloy wheels with 225/45 front, 255/40 rear **run-flat**¹ **performance tires.**^{2,3}



Double Spoke (Style 225M) 19 x 8.0 front, 19 x 9.0 rear light alloy wheels with 225/35 front, 255/30 rear **run-flat**¹ **performance tires.**^{2,3}

¹ Run-flat tires do not come equipped with a spare tire and wheel.

² Driving over rough or damaged road surfaces, as well as debris, curbs and other obstacles, can cause serious damage to wheels, tires and suspension parts. This is more likely to occur with low-profile tires, which provide less cushioning between the wheel and the road. Be careful to avoid road hazards and reduce your speed, especially if your vehicle is equipped with low-profile tires.

³ Performance tires are not recommended for driving in snow and ice conditions.



Three-spoke, leather-wrapped multi-function sport steering wheel lets you keep both hands on the wheel while adjusting both the audio and a Bluetooth® enabled mobile phone. Voice command can be used to change audio selections, Navigation system destinations and telephone entries.



Three-spoke, leather-wrapped multi-function M sport steering wheel includes a thick, textured rim and thumb indents that are designed for performance driving. Racing-inspired steering wheel-mounted paddle shifters allow fast, clutchless gear shifts.



6-speed STEPTRONIC automatic transmission provides a choice of three modes: "Drive" with Adaptive Transmission Control; a more dynamic "Sport" mode; and STEPTRONIC automatic, for the hands-on control of a manual without a clutch.



8-speed STEPTRONIC automatic transmission with Adaptive Transmission Control (ATC) provides extremely fast synchronized shifting in either the Sport or Manual shift mode. By increasing the number of gears to eight, the transmission provides a more efficient shifting sequence and improved fuel economy.



Dynamic cruise control with braking function reduces your set speed in curves for comfortable lateral acceleration. At the end of the curve, the X1 accelerates and resumes your original set speed.

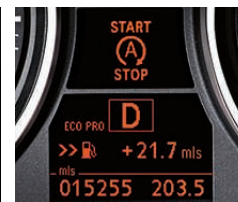

Auto Start-Stop display in the Info Display indicates when the engine has been switched off by the Auto Start-Stop function, such as when sitting at a traffic light. The display turns off when the engine automatically restarts.



Smartphone Integration, which provides connectivity for iPhone® and similar devices, is included with BMW Apps. This allows access to stored music, can improve signal reception, and recharges the phone battery. (Visit bmwusa.com/bluetooth or visit your authorized BMW center for compatible phone models.)



ECO PRO mode, which is activated via the Dynamic Driving Control switch, allows a particularly fuel-efficient style of driving.



Navigation system features iDrive system and a high-resolution, 8.8-inch glare-free monitor. Includes 3-D daytime and nighttime maps, zoom, travel planner and Advanced Real-Time Traffic Information on potential traffic problems. Offers up to 12 GB of space on an internal hard drive for storing your favorite entertainment media.



Auxiliary input port includes a 12-volt socket, letting you connect an external audio source, such as an iPod® or MP3 player. **Hands-free Bluetooth and USB adapter** provides a wireless connection between Bluetooth capable mobile phones and the vehicle, letting you scroll through and select music via the vehicle's radio controls, the multi-FUNCTION steering wheel buttons, or iDrive Controller. The integrated USB interface can be used to connect audio sources, such as iPods, MP3 players and USB sticks.



HiFi speaker system features eight speakers for brilliant sound. An available **Harman Kardon® Surround Sound System** delivers powerful amplification with 11 speakers for superb sound.

Wheel and tire specifications are subject to change. Get the latest information on BMW standard and optional features, packages and technical specifications. Visit bmwusa.com, select the BMW model of your choice, and click on "Features & Specs."

Equipment features and options.



8-way adjustable front sport seats feature special side bolsters and power backrest width adjustment to support you during spirited driving maneuvers. Seat fore/aft position, seat height, backrest angle, seat angle and thigh support can be manually adjusted.



8-way front seats allow manual adjustment of the seat height, fore/aft seat position, backrest angle and headrest height.



12-volt sockets are conveniently located underneath the fold-down center armrest, on the edge of the rear center console, and on the right side of the cargo area.



Lockable compartment at the top of the instrument panel offers spacious storage for travel necessities.



Automatic climate control system allows occupants to select a specific cabin temperature and choice of fan speeds, as well as automatic or manual airflow and recirculation. The automatic recirculation control activates whenever certain air pollutants are detected. The system also includes defrost/demist and MAX A/C functions.



BMW anti-theft AM/FM stereo CD/MP3 player includes Radio Data System, Auto-Store, and 3-channel FM diversity antenna; reads/displays song title.



Rear armrest features two integrated cupholders. The armrest can be raised to accommodate a third passenger.



Storage space abounds throughout the BMW X1 cabin. Pockets in all four doors accommodate various size bottles; tensioning belts in the front door pockets provide useful space for a variety of travel items.



Heated front seats are a welcome feature in cooler weather. Driver and front passenger can individually select from three settings for seat surfaces and backrests.



Power front seat adjustment customizes seat height, seat and backrest angle, and fore/aft position. Includes a two-driver memory function for driver's seat and power-folding exterior mirrors.



Lumbar support for front seats adds four-way adjustable comfort for the lower back. Lumbar support can be adjusted up/down and in/out.



Storage compartment under the cargo area floor includes four variable divider elements for flexible usage.



Extra cupholders can be mounted on the center console.



Cupholders are ergonomically positioned for easy access in the center console.

Original BMW Accessories.



V Spoke (Style 324) 19-inch Ferric Gray light alloy wheels, BMW Replacement Performance Carbon Fiber Mirror Caps, BMW Base Support System and BMW Roof Box 460 in Black.



BMW holder for Apple iPad® mounted on the back of the front headrests.



BMW Floormats provide a custom fit. Made of 100% pure rubber, they feature deep channels to trap water, slush, snow and dirt, and will not crack, curl or stiffen in any temperature.



Snap-in Adapter with USB interface makes it easy to hook up your mobile phone to make calls or play stored music, while it accesses the car antenna and charges the phone.



Heavy-duty cargo-area mat is specially tailored to fit the X1 cargo area and protect it from fluids and mud.

CRAFT YOUR OWN BMW – AT BMWUSA.COM/BYO.



At BMW, we want you to create your own Ultimate Driving Machine®. That's why BMW offers one of the widest model ranges of any luxury automotive manufacturer. And each BMW model offers its own universe of personalizing possibilities.

It's easy to get the latest information on your favorite BMW model. Simply visit bmwusa.com and click on the BMW model of your choice. Select **"Features & Specs"** to see all the standard features and available options and packages, as well as technical specifications.

Then create the exact BMW model that fulfills your needs by clicking on **"Build Your Own"** – or just visit bmwusa.com/byo. Here you'll be able to select from among the many interior and exterior colors and trims, personalizing options and value-added packages. Build a BMW model that reflects your style, then view it in 360° detail. At the press of a button, see payment and financing options, get a same-day quote, download a product brochure and even schedule a test drive. BMW makes it easier than ever to make your ultimate driving dreams come true, at bmwusa.com.

Driving a BMW is always a special experience – but it can be enhanced even further with Original BMW Accessories. These innovative products combine unique ideas, stunning design and easy functionality. Discover the wide range of Original BMW Accessories available to you, including accessories for the exterior, interior, technology, transporters, protection and details to customize your vehicle. For additional information on Original BMW Accessories, please visit your authorized BMW center or log on to shopbmwusa.com.

Technical data		X1 sDrive28i	X1 xDrive28i	X1 xDrive35i
----------------	--	--------------	--------------	--------------

Weight				
Unladen weight	lb	3527	3726	3891
Weight distribution, front / rear	%	49.4 / 50.6	50.6 / 49.4	52.1 / 47.9
Permitted payload	lb	904	904	904

Engine				
Type / cylinders / valves per cylinder		TwinPower Turbo Inline 4 / 4	TwinPower Turbo Inline 4 / 4	TwinPower Turbo Inline 6 / 4
Displacement	cc	1997	1997	2979
Bore / stroke	inch	3.30 / 3.50	3.30 / 3.50	3.30 / 3.50
Nominal output / rpm	hp	240 / 5000-6500	240 / 5000-6500	300 / 5800
Maximum torque / rpm	lb-ft	260 / 1250-4800	260 / 1250-4800	300 / 1300-5000
Compression ratio	:1	10.0	10.0	10.2

Transmission				
Automatic gear ratios				
I / II / III / IV	:1	4.71 / 3.14 / 2.11 / 1.67	4.71 / 3.14 / 2.11 / 1.67	4.71 / 2.34 / 1.52 / 1.14
V / VI / VII / VIII / R	:1	1.29 / 1.00 / 0.84 / 0.67 / 3.30	1.29 / 1.00 / 0.84 / 0.67 / 3.30	0.87 / 0.69 / - / - / 3.40
Final drive ratio	:1	3.15	3.15	3.64

Performance				
Top speed ¹	mph	127 [149]	127 [149]	127 [149]
Acceleration 0 – 60 mph ²	sec	6.2	6.3	5.3

Fuel consumption ³				
City	mpg	TBD	TBD	TBD
Highway	mpg	TBD	TBD	TBD
Tank capacity, approximate	gal	16.6	16.6	16.6

Figures in [] apply to vehicles with performance tires and increased top-speed limiter.

¹ Top speed limited electronically.

² BMW AG preliminary test results. Actual acceleration results may vary, depending on specification of vehicle; road and environmental conditions; testing procedures and driving style. These results should be used for comparison only and verification should not be attempted on public roads. BMW urges you to obey all posted speed laws and always wear safety belts.

³ EPA-estimated figures were not available at time of printing. Please go to bmwusa.com for latest available information. Figures are for comparison purposes only. Your actual mileage will vary, depending on speed, driving habits, trip length and driving conditions; actual mileage will most likely be lower.

Technical data		X1 sDrive28i	X1 xDrive28i	X1 xDrive35i
----------------	--	--------------	--------------	--------------

Wheels				
All-season tire dimensions		225 / 50	225 / 50	225 / 45
Wheel dimensions	inch	17 x 7.5	17 x 7.5	18 x 8.0
Material		light alloy	light alloy	light alloy

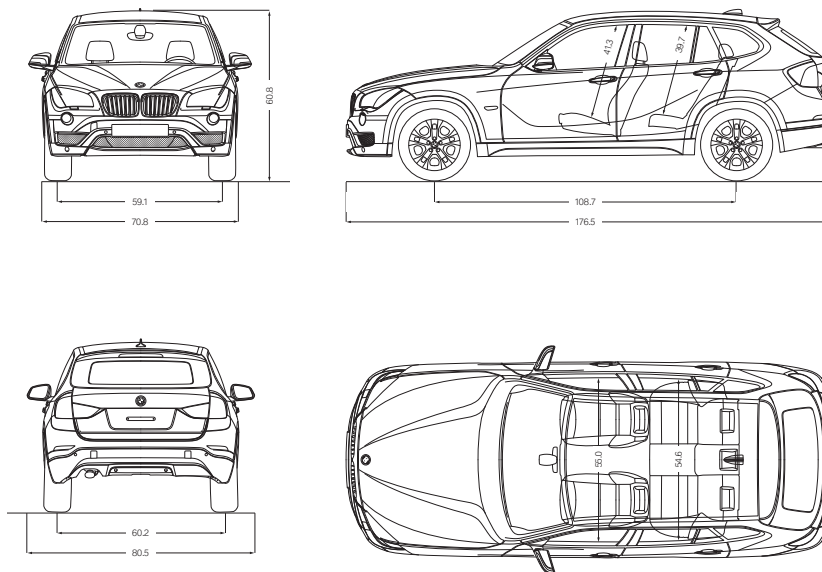

All dimensions in the technical drawings are given in inches.

U.S. Importer: BMW of North America, LLC, Woodcliff Lake, NJ 07677. All illustrations and specifications contained in this brochure are based on the latest product information available at the time of printing. BMW reserves the right to make changes at any time, without notice, in colors, materials, equipment, specifications, design and models. BMW may, subject to legal requirements, determine the Model Year designation of its vehicles. The Model Year designation on any particular model may be longer or shorter than 12 months. Some vehicles pictured may contain non-U.S. equipment. Some models may be shown with optional equipment. While BMW NA makes all reasonable efforts to provide accurate information in this brochure, there is no guarantee or warranty of accuracy. Furthermore, we do not assume any liability for the accuracy or completeness of information presented. This brochure shall not be used or relied upon as a substitute for information that is available from your authorized BMW center. Further information can be obtained from your authorized BMW center or bmwusa.com.

©2012 BMW of North America, LLC

Not to be reproduced wholly or in part without written permission of BMW NA. The BMW name, logo, model names, Sports Activity Vehicle and SAV are registered trademarks.

The Bluetooth word mark and logos are owned by the Bluetooth SIG, Inc. and any use of such marks by BMW is under license. iPhone, iPad and iPod are registered trademarks of Apple Inc. Other trademarks and trade names are the property of their respective owners.

We believe that a premium ownership experience should feature performance and luxury, as well as safety and convenience. We believe you should be able to drive a BMW to its potential, while enjoying peace of mind and reduced cost of ownership. That's the idea behind **BMW Ultimate Service**[®]; a suite of comprehensive programs and services that are included in every new BMW vehicle.

BMW Ultimate Service starts with the **New Vehicle/SAV Limited Warranty**,¹ providing you with coverage for the first four years or 50,000 miles, whichever comes first. Additionally, you have 12-year, unlimited-mileage warranty protection against corrosion and rust perforation.¹ The **BMW Maintenance Program**² and **BMW Roadside Assistance** also come standard, with **BMW Assist**^{™3} offered as an option.

GOING BEYOND ENGINEERING: THE HIGH-PERFORMANCE BMW OWNERSHIP EXPERIENCE.



BMW Maintenance Program is one of the most comprehensive maintenance programs in its class. We cover all factory-recommended maintenance during the New Vehicle/SAV Limited Warranty coverage period. This includes scheduled oil services and inspections. Also covered is the replacement of items that are subject to normal wear and tear, such as brake pads, wiper blade inserts and engine drive belts.² And, thanks to BMW's advanced engineering, most owners enjoy a well-balanced maintenance schedule, with flexible routine service intervals that can save you time. When your vehicle requires attention, your authorized BMW center ensures that it receives only genuine BMW parts – your assurance of exacting quality standards.

For more details and information on BMW Ultimate Service and the BMW Maintenance Program, visit your authorized BMW center or log on to bmwusa.com/ultimateservice.



BMW Assist Safety Plan is a four-year program that lets you enjoy peace of mind knowing that a friendly response specialist is there to help you, 24/7, at just the push of a button. The Safety Plan includes Automatic Collision Notification, Emergency Request, Enhanced Roadside Assistance, Door Unlock, Stolen Vehicle Recovery and Customer Relations. Included in the BMW Assist Safety Plan, MyInfo allows you to send business locations and street addresses with their associated phone numbers from the Google Maps™ website directly to your BMW. The destination can be sent to your Navigation system for turn-by-turn directions. With the BMW Navigation system and your mobile phone linked to your BMW via Bluetooth® technology, BMW's Mobile Office feature⁴ transfers text messages and emails to your iDrive Display screen and reads them aloud to you. A Calendar and To-do List can also appear on your Display screen while en route. Running late? Click on the phone number in the Calendar to call your appointment. For a list of tested mobile phones, visit bmwusa.com/bluetooth.

For the ultimate in coverage, add the optional **BMW Assist Convenience Plan**.⁵ You'll enjoy unlimited access to personalized Directions, Traffic and Weather reports, as well as our Concierge feature, which can send a destination address and phone number, such as a restaurant or hotel, right to your BMW. You can make up to four operator-assisted calls per year with Critical Calling if your cell phone is not available, or if its battery is discharged. BMW Online allows access to up-to-date fuel prices and the latest weather forecasts, as well as Bloomberg's stock indices and the powerful reach of the Google Maps database – delivered to the iDrive Display right inside your vehicle.

BMW's unique **TeleService**, included in the BMW Assist Safety Plan, continually monitors specific parts that are subject to wear and tear – including the engine oil, micro-filter, spark plugs, brake linings and various fluids – as well as services that require attention at regular intervals, such as vehicle service inspections. This data is automatically transmitted to your authorized BMW center, which

will then call you to schedule a service appointment. You don't have to keep track of when your vehicle requires routine maintenance. An added benefit: any needed maintenance service parts will already be on hand, so your BMW is serviced and returned to you as quickly as possible. And because they use only Original BMW Parts, you can rely on expert fit and long-lasting BMW quality. For more details on TeleService, visit bmwassist.com.



BMW Roadside Assistance is provided free of charge for the first four years – with no mileage limit. Call **1-800-332-4BMW (4269)** for friendly on-the-road help, 24/7, anywhere in the United States, Canada and Puerto Rico. This includes everything from flat-tire changes, emergency gasoline and lock-out service, to towing, alternative transportation and even trip-interruption benefits. This service also provides valuable trip-routing advice.



BMW Financial Services. Arranging to buy or lease a BMW is easier than you may think. Your authorized BMW center offers leasing and financing to suit your personal needs through BMW Financial Services.⁶ Start the process at our website, where you can build your "dream vehicle," get an estimate on a monthly lease or financing payment, submit a credit application to BMW Financial Services – and get approval – all online.⁶ To find out how BMW Financial Services can help put you behind the wheel of your favorite BMW model, log on to bmwusa.com/fs or call, toll-free, **1-800-578-5000**.



BMW Virtual Center. If you get the sudden urge to shop for a BMW but your authorized BMW center is closed, there's good news – the BMW Virtual Center is open 24 hours a day! Log on to bmwusa.com/byo, and choose the model that interests you. Configure the BMW of your dreams, and see what the monthly payments would be. You can even send the specifications to your authorized BMW center, apply for financing, or request a test drive – all online!



BMW Magazine. A fascinating view of the latest events and products in the world of BMW, including travel reviews, personality profiles, and the latest BMW technologies. Sent to new owners and lessees several times a year, you can also read articles from **BMW Magazine** on the BMW website at bmwusa.com under the "Media Gallery & Library" heading, found in the "Experience" section.



BMW Performance Driving School. Take your driving skills to the next level. Behind the wheel of our new BMWs and under the expert guidance of professional driving instructors, you'll hone your driving skills on a versatile driving course – 1.7 miles of asphalt that can be configured in a multitude of ways. In One- and Two-Day Schools you can tackle the skid pad, slalom course and water walls. The BMW Performance Driving School is about control and pushing a BMW to its limits – and yours.

Performance Center Delivery. You'll always remember the fun of taking delivery of your new BMW – especially with BMW Performance Center Delivery in Spartanburg, SC. After enjoying dinner and an overnight stay at a first-class hotel, we'll take you and your companion to the Performance Center where a Product Specialist will give you an in-depth introduction to your new BMW. Then at the Performance Driving School, you'll get tips from a professional driving instructor as you explore the dynamic capabilities of a similar model. It's exciting, it's enlightening – and it's all compliments of BMW with your new vehicle. To learn more about the BMW Performance Center, call **1-888-345-4269** or visit bmwusa.com/performancecenter.



BMW Welt: The BMW Welt ("BMW World") delivery and brand-experience center in Munich is bold proof of BMW's passion for design. When you take advantage of the BMW European Delivery Program,⁷ this is where you will meet your new BMW – in a personalized process that is highly dramatic and totally unforgettable. (You might also realize substantial savings that just may pay for your trip.) While you're there, marvel at the historic BMWs in the Museum; learn about our engineers' newest innovations in the Technology and Design Atelier; and take a tour of the plant to experience firsthand the state-of-the-art methods used to create a BMW. Then comes the unique experience of driving your new BMW on the roads it was designed for. To learn more, visit bmwusa.com/europeandelivery.

ON-BOARD SERVICE ALERTS.

We monitor your BMW's needs – so you don't have to.

Tackling mountain switchbacks, the last thing you should be thinking about is the state of your brake pads. Thanks to BMW's integrated on-board diagnostics system, you will always know exactly when the next service is due, and what work will be required. Condition-Based Service (CBS) measures the condition of key parts that are subject to wear and tear. It also tracks fluid levels and monitors your BMW's time- and mileage-dependent service requirements. Using this data, the Info Display in the cockpit automatically alerts you in advance whenever any part of your vehicle will require servicing – so there are no surprises ahead.

¹ See your authorized BMW center for details on these limited warranties.

² The BMW Maintenance Program covers factory-recommended maintenance services as determined by the Service Interval Indicator for all new eligible MY 2004 and later BMW vehicles. Specific additional items that need replacement due to normal wear and tear are also covered. The maintenance coverage period is for the first 4 years or 50,000 miles, whichever comes first. Exclusions from coverage include: gasoline, gasoline additives, windshield washer fluid and additives, battery, tires, wheels, wheel alignment and tire balancing. All work must be performed by an authorized BMW center. See the Service and Warranty Information booklet for specific terms, conditions and limitations. Further information can also be obtained from your authorized BMW center.

³ BMW Assist with 4 years of Safety Plan services is optional. In order to receive BMW Assist services, a subscriber agreement must be completed and transferred to the BMW Assist Response Center. GPS and underlying wireless services must be available and functioning; vehicle ignition must be turned on (except for Door Unlock and Stolen Vehicle Recovery), battery charged and connected and vehicle's electrical system operational; services may be limited to certain geographic areas. Call toll-free **1-888-333-6118**, go to bmwassist.com, or visit your authorized BMW center for additional program details. Services are subject to the terms and conditions of your subscriber agreement.

⁴ Not all mobile phones are compatible with Mobile Office, and some compatible phones support a limited number of Mobile Office functions. For the complete list of compatible mobile phones and the details regarding which Mobile Office functions are supported by each phone, please visit bmwusa.com/bluetooth.

⁵ Requires BMW Assist Safety Plan subscription. Services are subject to the terms and conditions of your subscriber agreement. Please go to bmwassist.com for additional details on the optional Convenience Plan.

⁶ Subject to credit approval and other terms and conditions.

⁷ Not all models available for BMW European Delivery Program. Please go to bmwusa.com or visit your authorized BMW center for details.

More about BMW



bmwusa.com
1-800-334-4BMW

The Ultimate
Driving Machine®



BMW and the environment.

BMW is a strong proponent of the environment and social responsibility. We launched BMW EfficientDynamics back in 2000 – the philosophy of providing greater power with increased efficiency and fewer emissions. This has resulted in significant benefits today – for our customers, the climate and the environment.

That year, ecological sustainability was also declared one of BMW's core strategic principles; it is now firmly anchored in our entire production chain. It starts with the development of fuel-saving and alternative vehicle concepts, continues with environmentally friendly production processes, and ends with innovative recycling methods. This effort has been recognized worldwide; in 1999, BMW AG – the parent company of BMW of North America and BMW Manufacturing Co. in Spartanburg, SC – was the first automotive company to be represented on the Dow Jones Sustainability Group Index. It has remained on the Index ever since; moreover, since 2005, BMW has been voted the world's most sustainable automobile manufacturer. At BMW, we strive for and achieve high performance in all we do.



BMW recommends **EDGE**