

X Close

# X PRIME.

Truly one of a kind, the BMW X1 is designed to thrill on all types of terrain. Its uncompromisingly stylish lines make it stand out in any environment while its potent TwinPower turbocharged engine propelles it to pole position when it comes to conquering the road ahead.



**BMW X1**

EXTERIOR COLORS

UPHOLSTERY

INTERIOR TRIMS

WHEELS / TIRES

PACKAGES

TECHNICAL DATA



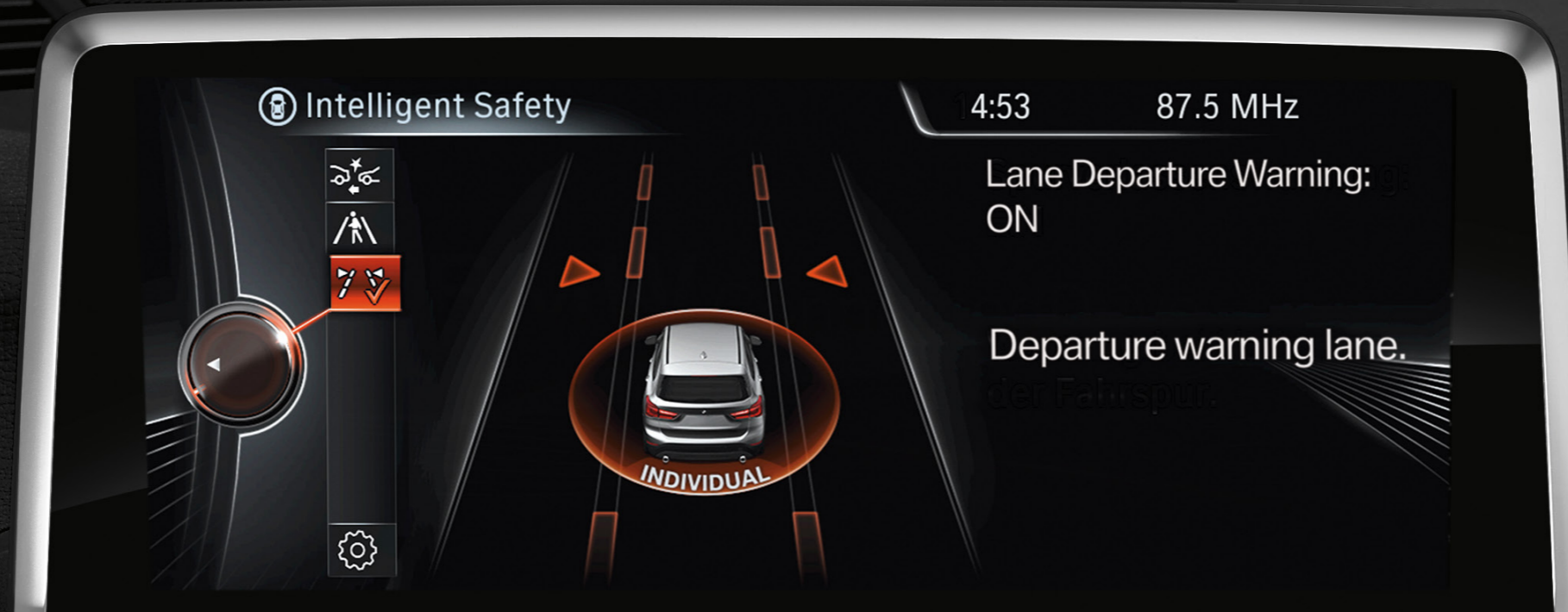

## CENTER OF ATTENTION.

The Lane Departure Warning<sup>1</sup> system provides support and active assistance to avoid dangerous situations. A camera recognizes the edge of the road and its markings, and the system warns the driver of unintentional lane changes.

<sup>1</sup> Requires clearly definable lane markings that are not obscured by rain, snow, etc. Lane Departure Warning feature is not a substitute for the driver's own responsibility in maintaining safe control of the vehicle.





## COMMAND CENTER.

It's a cinch to control the 8-speed Steptronic Automatic transmission with Sport and Manual shift modes from the luxurious driver's cabin. The iDrive controller is touch-sensitive and turns navigating into a simple task, while letting you focus on the road ahead.



# BMW X1 EXTERIOR COLORS

## NON-METALLIC

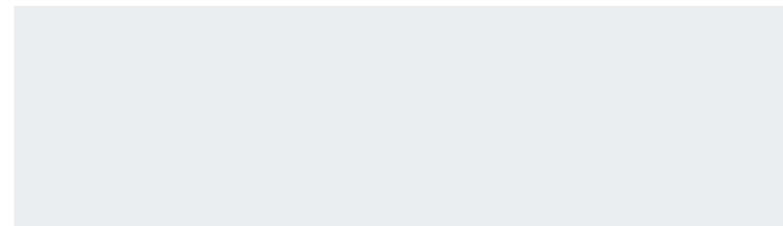

**300** Alpine White (Non-metallic)

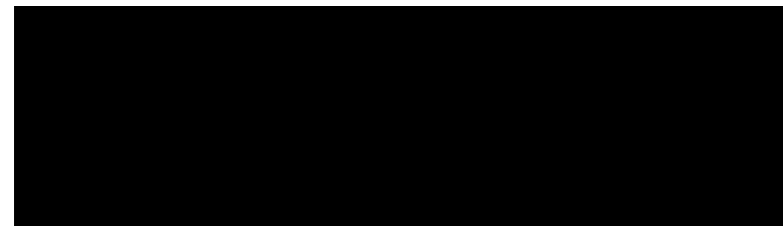

**668** Jet Black (Non-metallic)

## METALLIC

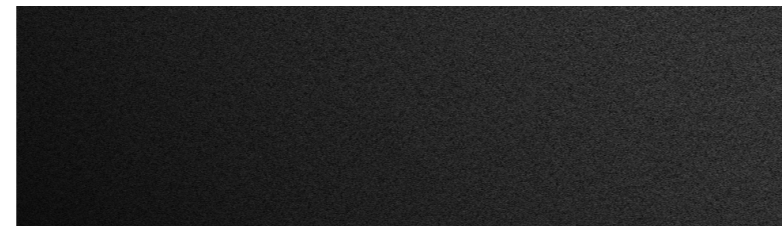

**475** Black Sapphire Metallic

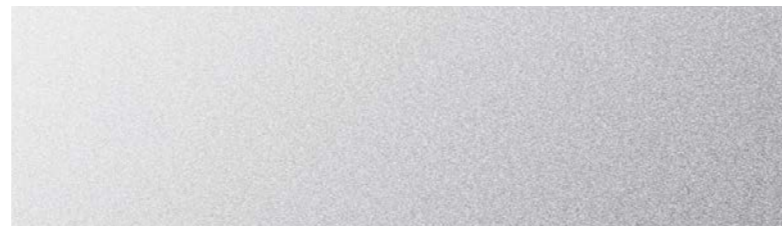

**A83** Glacier Silver Metallic

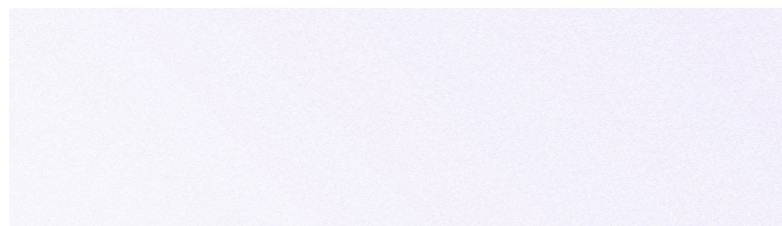

**A96** Mineral White Metallic

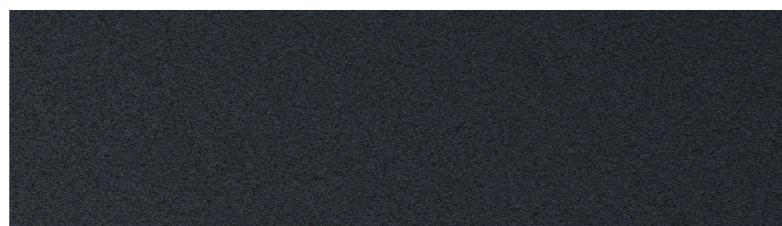

**B39** Mineral Gray Metallic

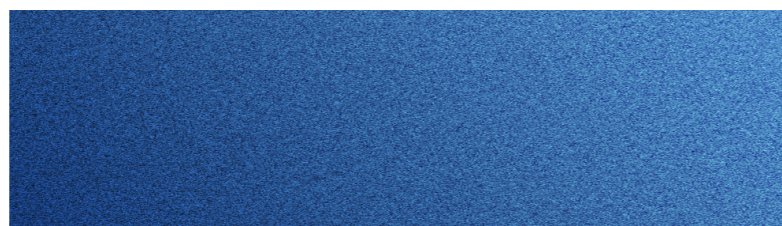

**B45** Estoril Blue Metallic

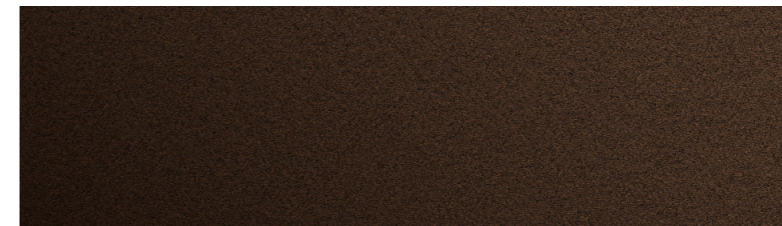

**B53** Sparkling Brown Metallic

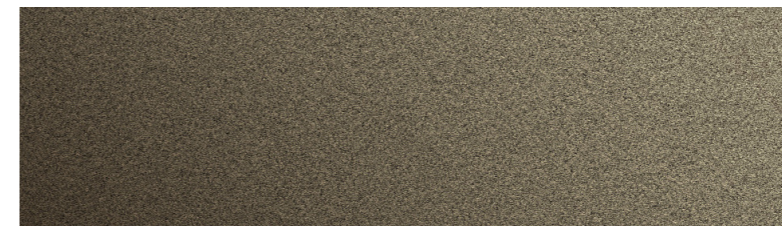

**C07** Dark Olive Metallic



**C10** Mediterranean Blue Metallic

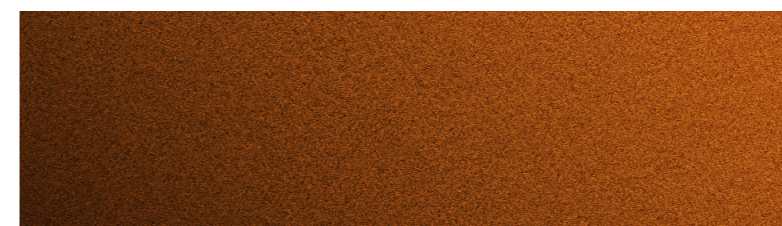

**C29** Chestnut Bronze Metallic



# BMW X1 UPHOLSTERY

## SENSATEC

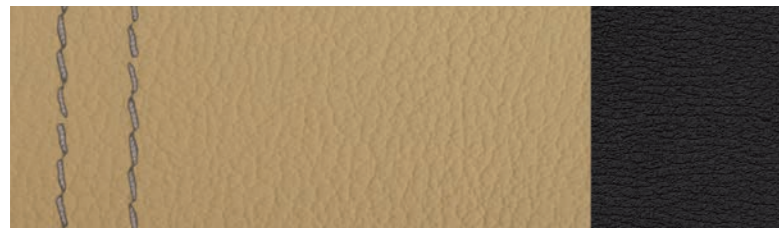

**KCFY** Canberra Beige SensaTec

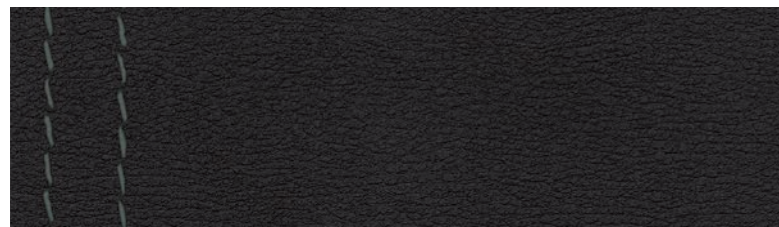

**KCSW** Black SensaTec

## DAKOTA LEATHER

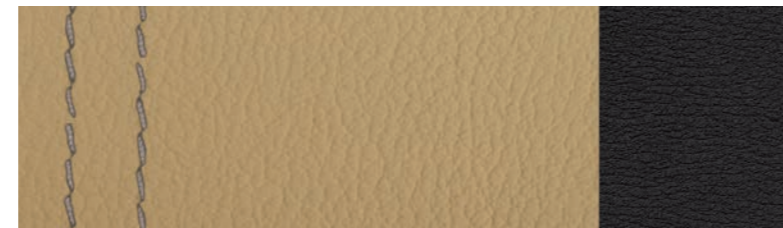

**PDFY** Canberra Beige Dakota Leather



**PDMZ** Mocha Dakota Leather



**PDOA** Oyster Dakota Leather



**PDSW** Black Dakota Leather

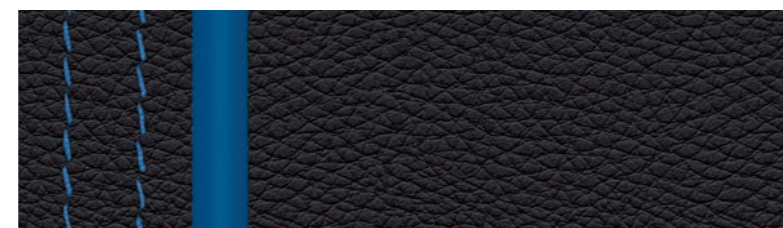

**PDN4** Black Dakota Leather / Blue Highlight

Leather: Leather on all seating surfaces; other components may be Leather or SensaTec.



# BMW X1 INTERIOR TRIMS



**4LU** High-gloss Black trim /  
Pearl Chrome highlight

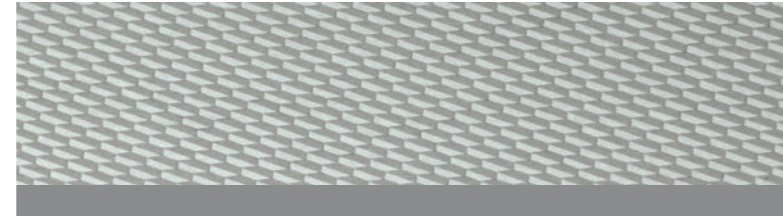

**4WE** Aluminum Hexagon trim /  
Pearl Chrome highlight

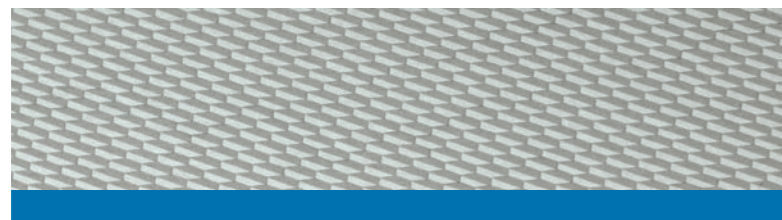

**4WF** Aluminum Hexagon trim /  
Estoril Blue matte highlight



**4F7** Fine-wood Oak Grain trim /  
Pearl Chrome highlight

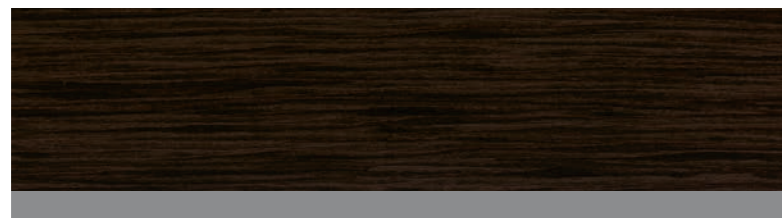

**4LR** Fine-wood Finline trim /  
Pearl Chrome highlight



**4LS** Brushed Aluminum trim /  
Pearl Chrome highlight



# BMW X1 WHEELS / TIRES



**Double Spoke Bicolor light alloy wheels (Style 570M)**  
18 x 7.5 front and rear; and 225/50 front and rear run-flat performance<sup>1,2,3</sup> or all-season tires<sup>1,2</sup>



**Double Spoke Bicolor light alloy wheels (Style 572M)**  
19 x 8.0 front and rear; and 225/45 front and rear run-flat performance tires<sup>1,2</sup>



**Y Spoke light alloy wheels (Style 569)**  
18 x 7.5 front and rear; and 225/50 front and rear run-flat all-season tires<sup>1,2</sup>



**Y Spoke light alloy wheels (Style 511)**  
19 x 8.0 front and rear; and 225/45 front and rear run-flat performance tires<sup>1,2,3</sup>



**Y Spoke light alloy wheels (Style 566)**  
18 x 7.5 front and rear; and 225/50 front and rear run-flat all-season tires<sup>1,2</sup>

<sup>1</sup> Does not come equipped with spare wheel and tire.

<sup>2</sup> Driving over rough or damaged road surfaces, as well as debris, curbs and other obstacles, can cause serious damage to wheels, tires and suspension parts. This is more likely to occur with low-profile tires, which provide less cushioning between the wheel and the road. Be careful to avoid road hazards and reduce your speed, especially if your vehicle is equipped with low-profile tires.

<sup>3</sup> Performance tires include Mobility Kit; not recommended for driving in ice and snow conditions.

Get the latest information on standard and optional features, packages and technical specifications. Visit [bmwusa.com](http://bmwusa.com) and select the BMW model of your choice.



# BMW X1 PACKAGES

## DRIVER ASSISTANCE PACKAGE

Rear-view Camera  
Park Distance Control  
Parking Assistant

## LUXURY PACKAGE

Fine-wood Oak Grain trim / Pearl Chrome highlight  
(options available)  
Dakota Leather Upholstery

## PREMIUM PACKAGE

Power-folding mirrors  
Universal garage-door opener  
Comfort Access keyless entry  
Panoramic moonroof  
Automatic-dimming driver exterior mirrors  
Automatic-dimming rear-view mirror  
Lumbar support  
Ambiance lighting  
LED Headlights with Cornering Lights  
SiriusXM® Satellite radio with 1-year subscription

## TECHNOLOGY PACKAGE

Head-up Display  
BMW Online and BMW Apps  
Advanced Real Time Traffic Information  
BMW Remote Services  
Enhanced USB and Bluetooth® plus  
Smartphone Integration  
BMW Navigation System with touchpad Controller  
BMW Connected App Compatibility

## DRIVER ASSISTANCE PLUS

Active Driving Assistant<sup>1</sup>  
Automatic high beams  
Speed Limit Info

## COLD WEATHER PACKAGE

Heated steering wheel  
Heated front seats

## M SPORT PACKAGE

18-inch Double Spoke Bicolor wheels (Style 570)  
(options available)  
Sport Automatic transmission  
High-gloss roof rails  
Sport seats  
Aluminum Hexagon trim with Estoril Blue matte highlight  
(options available)  
M sport suspension  
M steering wheel  
Aerodynamic kit  
Shadowline exterior trim

<sup>1</sup> Active Driving Assistant is not a substitute for the driver's own responsibility in maintaining safe control of the vehicle.



# BMW X1 TECHNICAL DATA



	sDrive 28i	xDrive28i
ENGINE	2.0-liter TwinPower Turbo inline 4-cylinder	
OUTPUT @ RPM	228 hp @ 5000-6000 / 258 lb-ft @ 1450-4500	
0-60 MPH (sec) <sup>1</sup>	6.6	6.3
CITY / HIGHWAY / COMBINED MPG	23/32/26	22/31/25

All dimensions in technical drawings are given in inches.

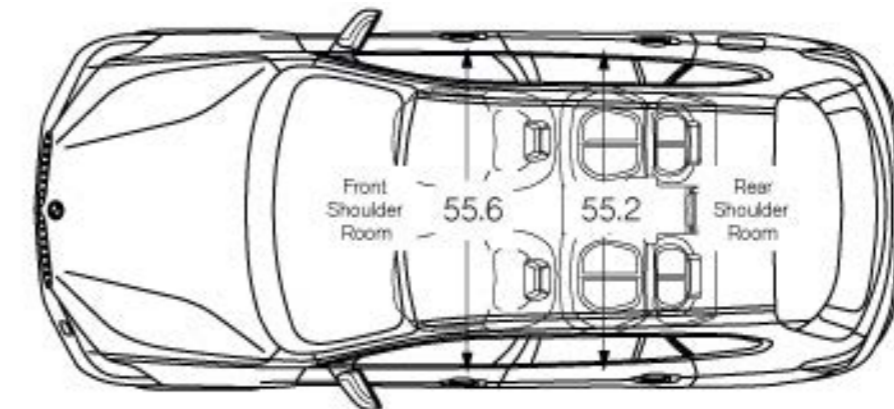
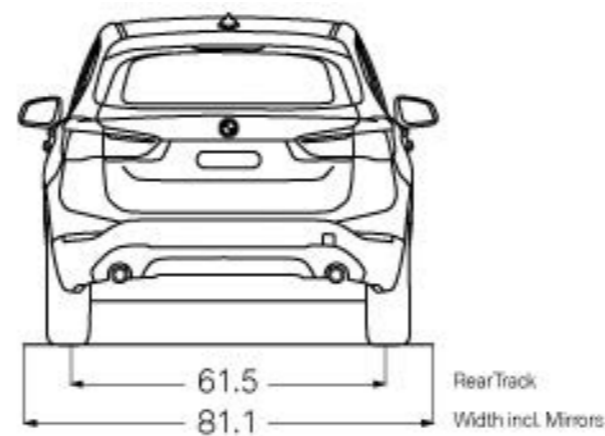
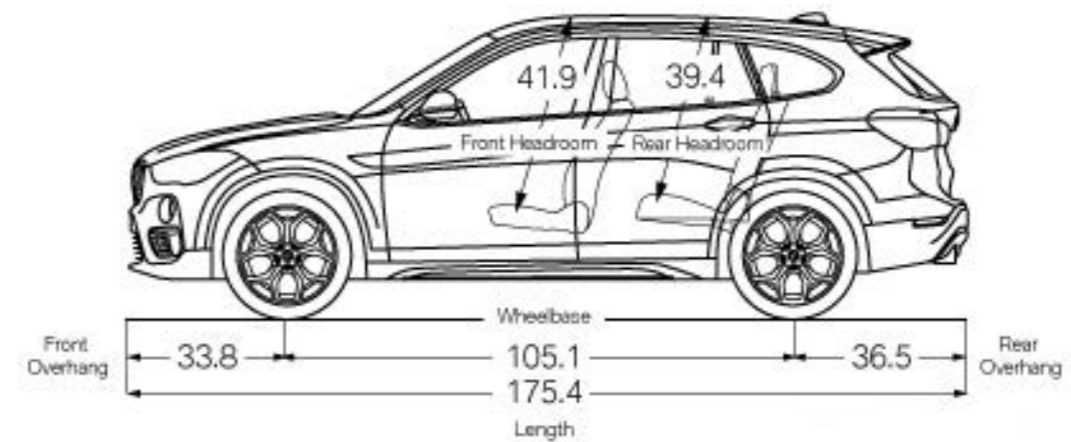
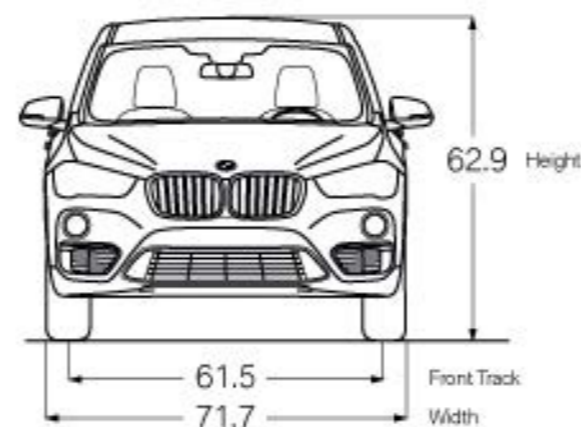

Figures subject to change. Please visit your BMW Retailer or [bmwusa.com](http://bmwusa.com) for the most up-to-date information.

<sup>1</sup>BMW AG preliminary test results. Actual acceleration results may vary, depending on specification of vehicle; road and environmental conditions; testing procedures and driving style. These results should be used for comparison only and verification should not be attempted on public roads. BMW urges you to obey all posted speed laws and always wear safety belts.

Get the latest information on standard and optional features, packages and technical specifications. Visit [bmwusa.com](http://bmwusa.com) and select the BMW model of your choice.