

**BMW 2006 X5
Sports Activity
Vehicle**

X5 3.0i
X5 4.4i
X5 4.8is



**The Ultimate
Driving Machine®**



British Columbia
JBB



**The 2006 X5 SAV: The perfect vehicle for the road ahead –
whether it's an Interstate or a gravel drive**



Extending the boundaries

**Designed for BMW-style performance –
no matter which road you take**



**The view from your seat of command:
clear, elegant, enticing.**





When it comes to horses, the more the merrier. The 355-hp X5 4.8is



Turns heads like a 355-horsepower drill.



BMW: Building impressive machines for over 80 years.



On-track performance. Buckle up.

Standard and Optional | Equipment



Xenon Adaptive Headlights optimize road illumination when entering a curve or bend, helping to enhance safety when driving at night. Sensors continuously monitor the vehicle's driving data to determine the direction and how much to swivel the headlights – up to 15 degrees to the left or right. (std. in X5 4.8is and X5 4.4i; opt. in X5 3.0i)



Panoramic moonroof with two-piece glass panels features fully electric slide and lift control. Includes comfort opening/closing function, a wind deflector to help keep the wind out, and an electric sun shade to help shield cabin from excessive heat. (std. in X5 4.8is; opt. in X5 3.0i and X5 4.4i)



A **four-spoke power tilt/telescopic leather-wrapped multi-function steering wheel** lets you keep both hands on the wheel while adjusting audio settings, cruise control and the accessory phone. (std. in X5 4.4i and X5 3.0i. Not available in X5 4.8is)



Heated steering wheel keeps your hands warm on cool days, letting you drive without gloves. (opt. in X5 4.8is; opt. in X5 4.4i and X5 3.0i, and requires Cold Weather Package)



Comfort seats cradle both the driver and front-seat passenger with 16-way power adjustments, including four-way settings for lumbar support and headrest, plus two-way upper backrest angle adjustment for totally individualized support and comfort. (opt. in X5 4.8is and X5 4.4i; not available in X5 3.0i)



Lumbar support for front seats adds four-way adjustable comfort for the lower back. Lumbar support can be adjusted up/down and in/out. (std. in all models)



STEPTONIC automatic transmission provides a choice of three modes: "Drive," which incorporates BMW's Adaptive Transmission Control; "Sport" automatic, for a more dynamic shift pattern; and STEPTRONIC automatic, for the hands-on control of a manual without using a clutch. (5-speed STEPTRONIC automatic transmission opt. in X5 3.0i; six-speed STEPTRONIC automatic transmission std. in X5 4.8is and X5 4.4i)



The close shift pattern of the **6-speed manual transmission**, standard in the X5 3.0i, delivers a precise, athletic feel for a more dynamic driving experience. (Not available in X5 4.8is or X5 4.4i)



On-board navigation system uses the GPS (Global Positioning System) satellites and BMW technology to help show – and tell – you the way to your destination. BMW's upgraded eight-function on-board computer is included with the DVD-based navigation system, as are controls for the audio system and (accessory) phone. Cassette deck replaces CD player. (opt. in all models)

Standard and Optional | Equipment



The **on-board computer** supplies you with useful travel information. In addition to basic data – outside temperature, average fuel economy, expected range on remaining fuel, and average speed – the eight-function on-board computer indicates a driver-set speed limit warning, distance to destination, and estimated time of arrival. (std. in all models)



Heated rear seats provide left and right rear-seat passengers with welcome warmth at the touch of a button. (std. in X5 4.8is; opt. in X5 4.4i and X5 3.0i, and requires Cold Weather Package)

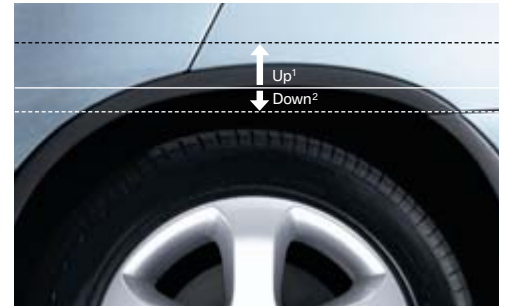

Adjustable Ride Height raises the vehicle 1.5"¹ to help protect the undercarriage of the X5 when driving over rough roads, and lowers the vehicle 0.8"² when stopped to ease entry and exit. (std. in X5 4.8is; opt. in X5 4.4i and X5 3.0i, and requires Sport Package)

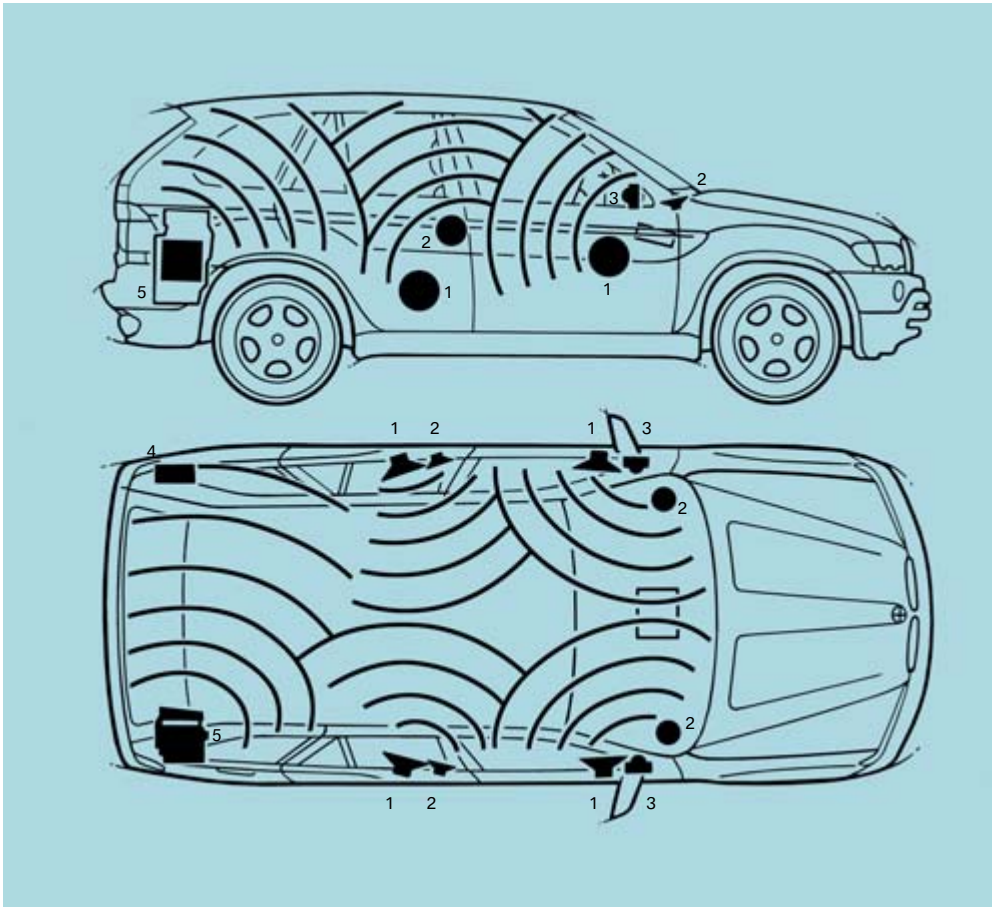































Upgraded audio system offers 12 speakers, including two subwoofers in the cargo compartment and two tweeters in the rear seating area, for incredibly lifelike sound. The system includes Digital Sound Processing, which can be set to create three different acoustic environments, such as a cathedral, concert hall and jazz club. (std. in X5 4.8is; opt. in X5 4.4i and X5 3.0i)



Park Distance Control uses eight sensors – four in front, four in the rear – to help you judge how close you are to other cars and unseen objects when parking. The warning beeps become faster as the bumper approaches the object, turning into a constant tone when the distance is less than 12 inches. (std. in X5 4.8is and X5 4.4i; opt. in X5 3.0i)

Combinations.

Materials	Leatherette ¹		Dakota Leather ²				Nappa Leather ³	
	Sand Beige	Black	Sand Beige	Gray	Truffle Brown	Black	Cream Beige	Black
Interior/Upholstery Colors								
Exterior Colors								
300 Alpine White 	●	●	●	●	●	●		
668 Jet Black 	●	●	●	●	●	●		
354 Titanium Silver Metallic 		●		●		●	●	●
472 Sterling Gray Metallic 		●		●		●		
440 Stratus Gray Metallic 		●		●		●		
481 Kalahari Beige Metallic 	●	●	●			●		
349 Olivine Green Metallic 	●	●	●			●		
A11 Highland Green Metallic 	●	●	●	●	●	●		
482 Toledo Blue Metallic 	●	●	●	●	●	●		
475 Black Sapphire Metallic 	●	●	●	●	●	●	●	●
381 LeMans Blue Metallic ⁴ 							●	●
405 Imola Red ⁴ 							●	●
Interior Trims								
Dark Grain Poplar Wood ⁵								
Light Grain Poplar Wood ⁶								
Anthracite Maple Wood ⁷								
Graphite ⁸								

¹ Leatherette upholstery: Standard in X5 3.0i. Not available in X5 4.4i or X5 4.8is.

² Dakota Leather upholstery: Standard in X5 4.4i. Optional in X5 3.0i and included in Premium Package. Not available in X5 4.8is.

³ Nappa Leather upholstery: Exclusive to X5 4.8is only. Not available in X5 3.0i or X5 4.4i.

⁴ LeMans Blue Metallic and Imola Red exterior paint: Exclusive to X5 4.8is only. Not available in X5 3.0i or X5 4.4i.

⁵ Dark Grain Poplar Wood interior trim: Standard in X5 3.0i and X5 4.4i. No-cost option in 4.8is.

⁶ Light Grain Poplar Wood interior trim: No-cost option in all models.

⁷ Anthracite Maple Wood interior trim: No-cost option in all models.

⁸ Graphite interior trim: Standard in X5 4.8is. Not available in X5 3.0i and X5 4.4i.

Note: Interior upholstery colors not available with all exterior paint finishes. This brochure shows the current recommended combinations of colors and materials. Specifications listed are subject to change without notice. See your local BMW center for accurate details. Since exterior paint samples and colors printed on paper can never perfectly match paint finishes and upholstery, we suggest you visit your local authorized BMW center to view the actual colors.

Standard Equipment | Optional Equipment

Performance and efficiency	3.0i	4.4i	4.8is	Exterior	3.0i	4.4i	4.8is
3.0-liter, 225-hp dual overhead cam (DOHC), 24-valve inline 6-cylinder engine with Double-VANOS steplessly variable valve timing	●			17 x 7.5 Star Spoke (Styling 130) cast-alloy wheels, and 235/65R-17 all-season tires	●		
4.4-liter, 315-hp 32-valve V-8 engine, 4 overhead camshafts, Valvetronic, and steplessly variable intake manifold		●		18 x 8.5 Double Spoke (Styling 153) cast-alloy wheels, and 255/55R-18 all-season tires		●	
4.8-liter, 355-hp 32-valve V-8 engine, 4 overhead camshafts, Valvetronic, and steplessly variable intake manifold			●	18 x 8.5 Y Spoke (Styling 131) cast-alloy wheels, and 255/55R-18 all-season tires	■		
6-speed manual transmission	●			18 x 8.5 Star Spoke (Styling 183) cast-alloy wheels, and 255/55R-18 all-season tires		■	
5-speed electronically controlled automatic transmission with Adaptive Transmission Control and STEPTRONIC gear selection, including Sport mode	○			19 x 9.0 front / 19 x 10.0 rear Star Spoke (Styling 132) wheels, and 255/50R-19 front, 285/45R-19 rear performance tires ²		○ ¹	
6-speed electronically controlled automatic transmission with Adaptive Transmission Control and STEPTRONIC gear selection, including Sport mode		●	●	20 x 9.5 front / 20 x 10.5 rear Star Spoke (Styling 168) wheels, and 275/40R-20 front, 315/35R-20 rear performance tires ²			●
				Spare tire – 235/65R-17 all-season tire on 17 x 7.5 cast-alloy wheel	●	●	
				Space-saver spare wheel with T155/90 D19 tire			●
				Xenon Adaptive Headlights with auto-leveling	○	●	●
				Halogen free-form low-beam headlights	●		
				Halogen free-form foglights	●	●	●
				High-pressure liquid headlight cleaning system	□	□	●
				Dual power/heated outside mirrors	●	●	●
				Intermittent rain-sensing windshield wipers with adjustable and vehicle-speed-sensitive wiping interval, single-wipe control, windshield-washer system with heated washer jets	●	●	●
				Rear-window wiper/washer with adjustable wiping interval	●	●	●
				Roof rails (accommodate various BMW roof carrier systems)	●	●	●
				Black chrome exhaust tips	■	■	
				Chrome exhaust tips			●
				Titanium-color front bumper grille insert	■	■	●
				Shadowline trim	■	■	●
				Metallic paint	●	●	●
				Body-color exterior door and tailgate handles	●	●	●
Handling, ride and braking							
xDrive all-wheel drive system	●	●	●				
All Season Traction for all-wheel drive	●	●	●				
Dynamic Stability Control (DSC-X) with Cornering Brake Control	●	●	●				
Dynamic Brake Control	●	●	●				
Hill Descent Control (HDC)	●	●	●				
Double-pivot strut-type front suspension	●	●	●				
Front subframe with dual hydraulic mounts	●	●	●				
Self-leveling rear axle with air springs	○	●	●				
Aluminum 4-link integral rear suspension	●	●	●				
Rear subframe on 4 rubber mounts	●	●	●				
Acoustically decoupled final drive with hydraulic rear mount	●	●	●				
Front and rear anti-roll (stabilizer) bars	●	●	●				
Twin-tube gas-pressure shock absorbers	●	●	●				
Engine-speed-sensitive power steering	●	●	●				
Sport suspension calibration	■	■	●				
Adjustable ride height	○ ¹	○ ¹	●				
4-wheel anti-lock disc brakes with ventilated front discs; electronic front/rear proportioning	●	●	●				

● Standard

○ Optional

◆ Premium Package

■ Sport Package

◇ Rear Climate Package

□ Cold Weather Package

△ BMW center-installed accessory

For the full selection of BMW X5 accessories, please see your authorized BMW SAV center.

¹ Requires Sport Package.

² Due to low-profile tires, please note: wheels, tires and suspension parts are more susceptible to road hazard and consequential damages. Performance tires are not recommended for driving in ice and snow.

Standard Equipment | Optional Equipment

Interior seating	3.0i	4.4i	4.8is	Comfort and convenience	3.0i	4.4i	4.8is
12-way power driver's and passenger's seat (includes 4-way power lumbar support) and memory system for driver's seat, steering wheel and outside mirrors (3 settings)	●	●		Vehicle & Key Memory	●	●	●
12-way power front sport seats (includes 4-way power lumbar support) with 2-way manual thigh support adjustment, and memory system for driver's seat, steering wheel and outside mirrors (3 settings)	■ ³	■	●	Panoramic moonroof with fully automatic, two-piece glass panels, power slide and lift control, wind deflector and electric interior sunshade	○/◆	○/◆	●
16-way power Comfort seats		○	○	Power windows with key-off operation; "one-touch" opening and closing of all door windows, anti-trapping feature, and opening from remote	●	●	●
3-stage heated front seats	□	□	●	Air conditioning	●	●	●
Front-seat center console with armrest, phone accommodation, storage compartment	●	●	●	Automatic front climate control with separate left/right temperature settings and automatic recirculation control	●	●	●
Rear-seat center armrest	●	●	●	Rear climate control	◇ ⁶	●	●
Heated rear seats (requires Cold Weather Package)	○	○	●	Active-charcoal micro-filter ventilation	●	●	●
Power adjustable rear seatbacks	◆	◆	●	Keyless entry with multi-function remote control; 2-step unlocking and remote tailgate release	●	●	●
Split folding rear seats	●	●	●	Park Distance Control (front and rear)	○	●	●
Leatherette upholstery	●			Automatic headlight control	●	●	●
Dakota Leather upholstery (seating, head restraints and door trim)	○/◆	●		Dual cupholders front and rear (total: 4-cup capacity)	●	●	●
Nappa Leather upholstery (seating, head restraints and door trim)			●	BMW Ambiance Lighting	●	●	●
Leather shift knob, handbrake grip and boot	●	●	●	Automatic tilt-down of right outside mirror for visibility of curb when backing up; includes "puddle" lights	●	●	●
4-spoke, power tilt/telescopic leather-wrapped steering wheel with cruise, audio and phone ⁴ controls	●	●		Automatic-dimming rear-view mirrors with compass ⁷	○	◆	●
3-spoke, power tilt/telescopic leather-wrapped sport steering wheel with cruise, audio and phone ⁴ controls	■	■	●	Privacy glass in rear windows	◇	◇	●
Heated steering wheel	○ ⁵	○ ⁵	○	Retractable cargo floor	○	○	○
Anthracite headliner	■	■	●	Audio system			
Dual front sun visors with illuminated mirrors	●	●	●	Anti-theft AM/FM stereo CD ⁸ radio with Radio Data System (RDS), 3-channel FM diversity antenna system	●	●	
Ski bag	□	□	●	High-fidelity 10-speaker sound system	●	●	
Rear-door-window sunshades	◇	◇	●	Premium high-fidelity 12-speaker sound system with Digital Sound Processing (DSP) and 2 subwoofers	○	○	●
Fully finished cargo area with velour carpeting; tool kit under floor	●	●	●	Pre-wiring for BMW mobile phone systems	●	●	●
Retractable cargo cover	●	●	●	iPod Seamless Integration System ⁹	△	△	△
				SIRIUS Satellite Radio ⁹	△	△	△

³ Requires Leather upholstery or Premium Package.

⁴ When vehicle is so equipped.

⁵ Requires Cold Weather Package.

⁶ Requires Premium Package.

⁷ Includes both inside and outside mirrors. Inside mirror includes compass with digital read-out.

⁸ CD player not available with optional navigation system.

⁹ For additional information, please visit your authorized BMW SAV center.

Standard Equipment | Optional Equipment

Instrumentation and controls	3.0i	4.4i	4.8is	Premium Package ¹²	3.0i	4.4i	4.8is
Service Interval Indicator	●	●	●	Dakota Leather upholstery (seating, head restraints and door trim)	◆/○	●	
Electronic analog instrumentation with LED illumination	●	●	●	Panoramic moonroof with fully automatic, 2-piece glass panels, power slide and lift control, wind deflector and electric interior sunshade	◆/○	◆/○	●
Outside-temperature display	●	●	●	Power adjustable rear seatbacks	◆	◆	●
Check Control vehicle monitor	●	●	●	BMW Assist ¹⁰ with Bluetooth® wireless communication system	◆/○	◆/○	●
8-function on-board computer	●	●	●	Automatic-dimming rear-view mirrors including compass with digital read-out	○	◆	●
On-board DVD-based navigation system (not available with in-dash CD player)	○	○	○				
Time-delay courtesy lights with actuation from driver's exterior door handle or remote control; automatic switch-on when engine is turned off	●	●	●				
Rear-window defroster	●	●	●	Sport Package¹²			
Interior tailgate release, electrically operated	●	●	●	Sport suspension calibration	■	■	●
Separately controllable front and rear reading lights	○	●	●	Shadowline trim	■	■	●
BMW Universal Transceiver (garage-door opener)	●	●	●	12-way power front sport seats (includes 4-way power lumbar support) with 2-way manual thigh support adjustment, and memory system for driver's seat, steering wheel and outside mirrors (3 settings)	■ ¹³	■	●
Tire pressure monitor	●	●	●	3-spoke, power tilt/telescopic leather-wrapped sport steering wheel with cruise, audio and phone ¹⁴ controls	■	■	●
Chrome rings on instrument cluster surrounds	■	■	●	Chrome rings on instrument cluster surrounds	■	■	●
				Anthracite headliner	■	■	●
Safety and security				Black chrome exhaust tips	■	■	
Dual front-impact airbag Supplementary Restraint System (SRS) with dual-threshold and dual-stage deployment	●	●	●	Titanium-color front bumper grille insert	■	■	●
3-point safety belts and head restraints at all seating positions	●	●	●	18 x 8.5 Y Spoke (Styling 131) cast-alloy wheels, and 255/55R-18 all season tires	■		
Front safety belts with automatic pretensioners and force limiters	●	●	●	18 x 8.5 Star Spoke (Styling 183) cast-alloy wheels, and 255/55R-18 all season tires		■	
Front- and rear-compartment Head Protection System (HPS) with front side-impact airbags	●	●	●	19 x 9.0 front / 19 x 10.0 rear Star Spoke (Styling 132) wheels, and 255/50R-19 front, 285/45R-19 rear performance tires ^{15, 16}		○	
Rear-door-mounted side-impact airbags	○	○	○	Adjustable ride height ¹⁵	○	○	●
Integrated deployment logic for safety-belt pretensioners, airbags and post-impact safety measures	●	●	●				
Adaptive Brake Lights	●	●	●	Rear Climate Package¹²			
Battery Safety Terminal	●	●	●	Rear climate control	◇ ¹⁷	●	●
Central locking system	●	●	●	Privacy glass in rear windows	◇	◇	●
Coded Driveway Protection	●	●	●	Rear-door-window sunshades	◇	◇	●
Alarm system with operation from keyhead remote, interior motion detector	●	●	●				
BMW Assist ¹⁰ with Bluetooth® wireless communication system	○/◆	○/◆	●	Cold Weather Package¹²			
				3-stage heated front seats	□	□	●
BMW Maintenance Program				High-pressure liquid headlight cleaning system	□	□	●
BMW Maintenance ¹¹	●	●	●	Ski bag	□	□	●

- Standard
- Optional
- ◆ Premium Package
- Sport Package
- ◇ Rear Climate Package
- Cold Weather Package

¹⁰ Please see your authorized BMW center for limitations and rules on subscription services provided with BMW Assist.

¹¹ BMW Maintenance Program covers all factory-recommended maintenance on all new MY 2004 and later BMW vehicles, as determined by the Service Interval Indicator, for 4 years or 50,000 miles, whichever comes first. Exclusions from coverage: gasoline, gasoline additives, windshield washer fluids and additives, lights, tires, wheels, wheel alignment, tire balancing and rotation. All work must be performed by an authorized BMW center. See the Service and Warranty Information booklet for more specific terms, conditions and limitations. Further information can be obtained from your local authorized BMW center.

¹² Packages can be ordered together.

¹³ Requires Leather upholstery or Premium Package.

¹⁴ When vehicle is so equipped.

¹⁵ Requires Sport Package.

¹⁶ Due to low-profile tires, please note: wheels, tires and suspension parts are more susceptible to road hazard and consequential damages. Performance tires are not recommended for driving in ice and snow.

¹⁷ Requires Premium Package.

Technical | Data

Performance data		3.0i	4.4i	4.8is	General		3.0i	4.4i	4.8is
Acceleration, 0-60 mph ¹	sec	7.8 (8.3)	6.8	5.9	Curb weight	lbs	4652 (4696)	4927	5016
Top speed ²	mph	130	130	153	Weight distribution	front/rear, %	48.1/51.9 (48.6/51.4)	49.7/50.3	
Fuel economy, EPA est. mpg ³	manual automatic	15/21 16/21	16/22	16/21	Wheelbase	in	111.0	111.0	111.0
Accommodations					Track, front/rear	in	62.0/62.0	61.4/61.4	61.7/62.8
					Seating capacity	persons	5	5	5
Shoulder room, front/rear	in	58.0/57.2	58.0/57.2	58.0/57.2	Width	in	73.7	73.7	73.7
Head room, front ⁴ /rear	in	39.9/38.5	39.9/38.5	39.9/38.5	Height ⁵	in	67.5	67.2	67.2
Chassis					Ground clearance	in	8.3	8.0	6.5
					Trailer-towing capacity ⁶	lbs	6000	6000	6000
Front suspension	3.0i		4.4i		4.8is				
Rear suspension	3.0i		4.4i		4.8is				
Steering type	3.0i		4.4i		4.8is				
Steering ratio	3.0i		4.4i		4.8is				
Turns, lock-to-lock	3.0i		4.4i		4.8is				
Turning circle, ft.	3.0i		4.4i		4.8is				
Wheels, standard	3.0i		4.4i		4.8is				
Wheels, optional (Sport Package) ⁷	3.0i		4.4i		4.8is				
Tires, standard	3.0i		4.4i		4.8is				
Tires, optional (Sport Package)	3.0i		4.4i		4.8is				
4-wheel disc brakes (front/rear)	3.0i		4.4i		4.8is				
Stability-enhancement systems	3.0i		4.4i		4.8is				

Figures in () refer to X5 3.0i with automatic transmission.

¹ BMW AG test results. Actual acceleration results may vary, depending on specification of vehicle; road and environmental conditions; testing procedures and driving style. These results should be used for comparison only and verification should not be attempted on public roads. **BMW urges you to obey all posted speed laws and always wear safety belts.**

² Top speed limited electronically.

³ EPA-estimated figures are for comparison purposes only. Your actual mileage will vary, depending on speed, driving habits, trip length and driving conditions; actual mileage will most likely be lower.

⁴ Without moonroof.

⁵ Measurements do not include roof rail height of 1.8 inches.

⁶ BMW NA does not supply or have an approved electrical brake controller for the Trailer Hitch (Tow Bar) Kits.

⁷ Due to low-profile tires, please note: wheels, tires and suspension parts are more susceptible to road hazard and consequential damages. Performance tires are not recommended for driving in ice and snow.

Technical | Data

Drivetrain	3.0i	4.4i	4.8is
Drive system	Front engine/xDrive all-wheel drive system with All Season Traction	Front engine/xDrive all-wheel drive system with All Season Traction	Front engine/xDrive all-wheel drive system with All Season Traction
Manual transmission	6-speed manual transmission	–	–
Gear ratios	1st 5.13:1 2nd 2.83:1 3rd 1.78:1 4th 1.26:1 5th 1.00:1 6th 0.83:1 Reverse 4.64:1	– – – – – – –	– – – – – – –
Final drive ratio	4.10:1	–	–
Automatic transmission	5-speed with Adaptive Transmission Control & STEPTRONIC automatic/clutchless manual	6-speed with Adaptive Transmission Control & STEPTRONIC automatic/clutchless manual	6-speed with Adaptive Transmission Control & STEPTRONIC automatic/clutchless manual
Gear ratios	1st 3.42:1 2nd 2.22:1 3rd 1.60:1 4th 1.00:1 5th 0.75:1 Reverse 3.03:1	1st 4.17:1 2nd 2.34:1 3rd 1.52:1 4th 1.14:1 5th 0.87:1 6th 0.69:1 Reverse 3.40:1	1st 4.17:1 2nd 2.34:1 3rd 1.52:1 4th 1.14:1 5th 0.87:1 6th 0.69:1 Reverse 3.40:1
Final drive ratio	4.10:1	4.10:1	3.91:1
Body			
Type	Unitized all-steel structure	Unitized all-steel structure	Unitized all-steel structure
Aerodynamic drag coefficient C _d	0.35	0.36	0.38
EPA classification	Light-duty truck	Light-duty truck	Light-duty truck
Engine			
Engine type	DOHC 24-valve inline six-cylinder	4-overhead-cam 32-valve V-8	4-overhead-cam 32-valve V-8
Bore x stroke, in/mm	3.31 x 3.53 / 84.0 x 89.6	3.62 x 3.26 / 92.0 x 82.7	3.66 x 3.48 / 93.0 x 88.3
Displacement, cu in/cc	181.8 / 2979	268.4 / 4398	292.9 / 4799
Compression ratio	10.2:1	10.0:1	10.5:1
Power @ rpm, hp	225 @ 5900	315 @ 5400	355 @ 6200
Torque @ rpm, lb-ft	214 @ 3500	324 @ 3600	369 @ 3500
Engine-management system	Siemens MS43; Double-VANOS steplessly variable intake and exhaust valve timing, engine cooling & other functions included in control strategy	Motronic ME 9.2.1; Valvetronic variable valve lift, Double-VANOS steplessly variable intake and exhaust valve timing, engine cooling & other functions included in control strategy	Motronic ME 9.2.1; Valvetronic variable valve lift, Double-VANOS steplessly variable intake and exhaust valve timing, engine cooling & other functions included in control strategy
Fuel requirement	Premium unleaded (min. 91 octane)	Premium unleaded (min. 91 octane)	Premium unleaded (min. 91 octane)
Fuel capacity, U.S. gal	24.3	24.3	24.3
Emission control	3-way catalytic converter, dual oxygen sensors, secondary air injection, closed-loop mixture control (50 states)	3-way catalytic converter, dual oxygen sensors, secondary air injection, closed-loop mixture control (50 states)	3-way catalytic converter, dual oxygen sensors, secondary air injection, closed-loop mixture control (50 states)
Emissions certification*	Ultra-Low Emission Vehicle (ULEV)	Low Emission Vehicle (LEV)	Low Emission Vehicle (LEV)
* EPA/California Air Resources Board			

All vehicle specifications contained in this document are based on the latest product information available at the time of printing. BMW reserves the right to make changes, without notice, in colors, materials, equipment, specifications and models. Further information can be obtained from your authorized BMW SAV center or bmwusa.com.

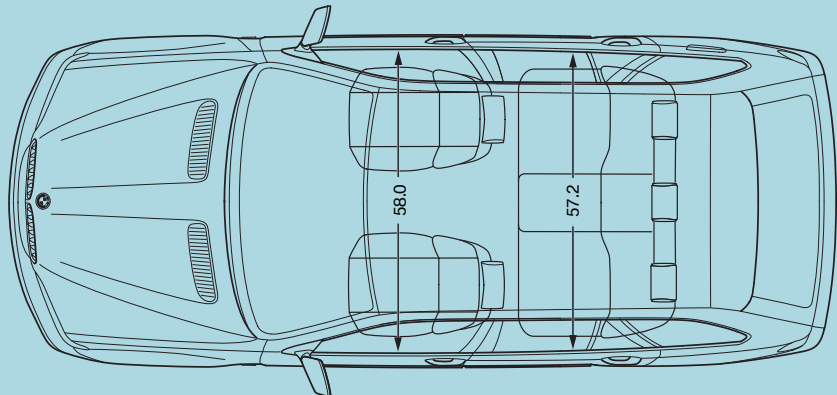
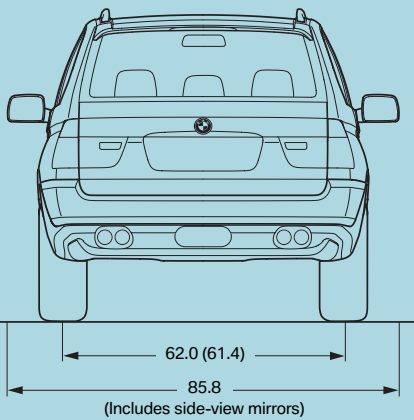
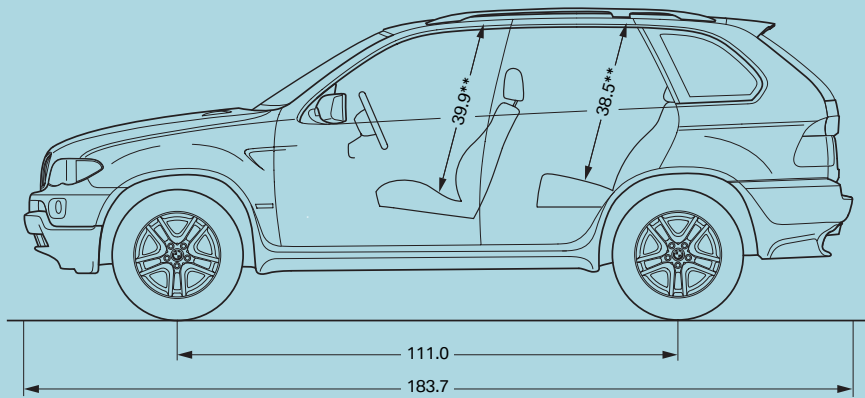
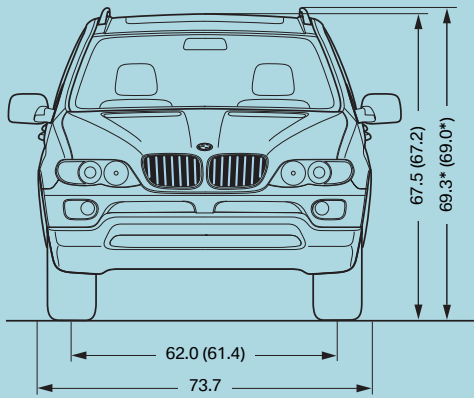

All dimensions in inches.
 Figures in () refer to X5 4.4i and X5 4.8is.
 * Including roof rails.
 ** Without panoramic moonroof.

Make your mark on the X5. Have the Sports Activity Vehicle you've always wanted. Exactly the way you've always wanted it. BMW gives you the choice. Don't compromise! ■

U.S. Distributor: BMW of North America, LLC, Woodcliff Lake, NJ 07677. All illustrations and specifications contained in this brochure are based on the latest product information available at the time of printing. BMW reserves the right to make changes at any time, without notice, in colors, materials, equipment,

specifications and models. BMW may, subject to legal requirements, determine the Model Year designation of its vehicles. The Model Year designation on any particular model may be longer or shorter than 12 months. Some vehicles pictured may contain non-U.S. equipment. Some models may be shown with optional equipment. Further information can be obtained from your authorized BMW SAV center or bmwusa.com.

©2006 BMW of North America, LLC. Not to be reproduced wholly or in part without written permission of BMW NA. The BMW name and logo are registered trademarks.

The Bluetooth word mark and logos are owned by the Bluetooth SIG, Inc. and any use of such marks by BMW is under license. Other trademarks and trade names are those of their respective owners.