

BMW  
X6 Sports Activity  
Coupe®

X6 xDrive35i  
X6 xDrive50i  
ActiveHybrid X6



The Ultimate  
Driving Machine®



# THE BMW X6.

TEST THE LIMITS OF EXHILARATION.

**BMW EfficientDynamics**  
Less emissions. More driving pleasure.



## THE BMW X6.

A UNIQUE CONCEPT IN POWER,  
PLEASURE AND ALL-ROADS  
PERFORMANCE.

**BMW EfficientDynamics**  
Less emissions. More driving pleasure.

### Contents

#### BMW X6 Sports Activity Coupe®

04 | 13 Exterior  
14 | 17 Interior

#### Technology

18 | 19 BMW EfficientDynamics  
20 | 21 Engines  
22 | 25 BMW ActiveHybrid X6  
26 | 27 Dynamic Performance Control | Active Steering | Adaptive Drive  
28 | 29 Safety features | Head-up Display  
30 | 31 BMW ConnectedDrive

#### Equipment

32 | 35 Exterior colors | Upholsteries | Interior trims | Combinations  
36 | 37 Selection examples  
38 | 39 Interior luggage compartment  
40 | 48 Equipment features and options  
49 BMW Individual  
50 | 51 Standard safety features and technology illustrations  
52 | 54 Build Your Own | Technical data  
55 Original BMW Accessories  
56 | 57 BMW Services



Want the inside scoop on BMW?  
You can find us on Facebook® at  
[facebook.com/bmwusa](https://www.facebook.com/bmwusa).

The silhouette of a sleek, muscular coupe. The dynamic traction of an SAV.® The lightning-quick cornering of Dynamic Performance Control. The availability of advanced ActiveHybrid power. The BMW X6 is the world's first four-door Sports Activity Coupe – a concept where TwinPower Turbocharging, sophisticated luxury, and flexible storage and seating all support your driving ambitions.



BMW X6 xDrive50i shown with the following equipment:

Engine: 32-valve, TwinPower Turbo  
4.4-liter V-8  
Exterior color: Vermilion Red Metallic  
Upholstery: Oyster Nevada Leather  
Interior trim: Dark Bamboo Wood  
Optional equipment: Sport Package, Y Spoke  
(Style 336) 20-inch light alloy  
wheels, Cold Weather Package

**BMW X6**



For details on paint, upholstery and interior trims, please refer to pages 32-35.



## THE ALLURE OF THOUGHTFUL DESIGN.

BMW's engineers and designers have created an exciting and practical class of all-wheel-drive vehicles: a Sports Activity Coupe®. Equal parts sensual and sensible, its sure-footed athleticism and striking appearance are matched by the practicality of four doors and a usable cargo area. It's a vehicle that makes no compromises in performance – on the road or in your daily life.







**BREAKING NEW GROUND.  
SETTING NEW STANDARDS.**





**IGNITE YOUR DRIVING PASSION AT EVERY TURN.**

The BMW X6's innovative, sporty look reflects the components that give it a sports car-like driving feel that's not usually associated with AWD vehicles. In addition to a powerful engine and taut suspension, BMW's revolutionary Dynamic Performance Control technology can transfer power between the rear wheels for quick high-performance cornering. Adaptive Drive adds Active Roll Stabilization (ARS) and Dynamic Damping Control (DDC) to the mix. ARS helps eliminate body roll, keeping the vehicle level, stable and agile; DDC continuously adjusts the shock absorbers from the softest to the firmest settings for outstanding compliance and body control. In the BMW X6, it all comes together in a unique driving experience.

Get the latest information on BMW standard and optional features, packages and technical specifications. Visit [bmwusa.com](http://bmwusa.com), select the BMW model of your choice, and click on "Features & Specs."



## ADAPTABLE GRIP AND SMART BRAKES TO CONQUER ANY ROAD, IN ANY WEATHER.

Not all roads are dry and level. That's good news for the BMW X6. It welcomes challenges, easily tackling rough surfaces, tight corners, steep climbs and steeper downhills. On steep downhill grades, press the Hill Descent Control button to help keep the BMW X6 to a steady crawl without even touching the brakes. Speaking of brakes, Dynamic Stability Control includes four innovative brake-optimizing features. When stopped on a hill, **Start-off Assistant** helps keep the BMW X6 from rolling after you take your foot off the brake pedal. When you quickly take your foot off the accelerator, **Brake Stand-by** anticipates the need for a short stop, and pre-tenses the calipers. Whenever moisture is detected, **Brake Drying** periodically, discreetly brings the brake pads into contact with the rotors to help dry them. And on long, gradual downhill slopes, BMW's **Brake Fade Compensation** helps keep your brake pedal action even, so you don't have to keep increasing brake pressure.





**DRIVE ALL YOU WANT –  
YOU CAN'T THROW IT OFF GUARD.**

In addition to inventing its own class, the BMW X6 brings with it a host of innovative technologies. For example, power distribution is nominally 40% front axle, 60% rear, for balanced handling. However, BMW's xDrive intelligent all-wheel-drive technology continuously and undetectably transfers power forward and back between both axles, depending upon which has greater traction. Dynamic Performance Control adds a secondary functionality of shifting power between the rear wheels. This helps maintain the sportier driving dynamics associated with rear-wheel-drive vehicles, so you get the best of both worlds: sporty road feel combined with pavement-hugging traction. It's an idea that perfectly fits the BMW X6.







## INSIDE A UNIQUE VEHICLE, A FAMILIAR PERSPECTIVE.

The BMW X6 may be difficult to classify at first glance. But from behind the wheel, it looks exactly like a BMW. The leather-wrapped multi-function sport steering wheel swiftly transmits your every driving input. Steering wheel-mounted paddle shifters make shifting through the gears a motorsport-inspired experience. Every gauge and instrument dial is easy to read; every control is conveniently placed within arm's length. Standard appointments include iDrive, which offers a variety of entertainment and communications options, six programmable memory buttons, and a hard drive with 12 GB of space that can store up to 2,000 songs. A unique touch: kneepads that give your legs a better grip in tight turns. And the commanding seat position reminds you that once you're in the BMW X6, you're in charge of the road.



## 360 DEGREES OF PURE BMW LUXURY.

You have to hand it to the BMW designers: they truly understand the concept of comfort. The BMW X6 offers a spacious interior, with a surprising amount of leg- and headroom for both the front and back seats. And while some all-wheel-drive vehicles may favor utility over luxury, the BMW X6 impresses with a wealth of premium interior features, such as supple Nevada Leather upholstery and exotic Dark Bamboo Wood trim. So no matter what the scenery outside offers, the view of the cabin is always first-rate.

Get the latest information on BMW standard and optional features, packages and technical specifications. Visit [bmwusa.com](http://bmwusa.com), select the BMW model of your choice, and click on "Features & Specs."





## BMW EFFICIENT DYNAMICS: VEHICLES THAT REQUIRE LITTLE AND GIVE A LOT.

BMW was one of the first automotive manufacturers to pursue efficient driving technologies – one part of our award-winning sustainability strategy. Our commitment to EfficientDynamics means we are continuously developing innovative systems that bring us closer to our long-term goal of emissions-free mobility. However, we remain equally committed to driving pleasure, which is being pursued in different ways. First, there is the continuing optimization of conventional diesel- and gasoline-powered models. Second, BMW hybrid vehicles are already on the road. Third, the first 100% electrically powered BMW – the BMW ActiveE – is being distributed in a field trial to customers. And fourth, the fleet of BMW Hydrogen 7 vehicles impressively demonstrated the potential for combining hydrogen drive with a combustion engine.

Since 1995 BMW has been able to reduce the CO<sub>2</sub> emissions of its entire fleet by approximately 30 percent. BMW has rolled out more than two million vehicles equipped with EfficientDynamics: 31 models already produce less than 225g of CO<sub>2</sub> per mile, and BMW intends to achieve a further 25 percent reduction by 2020. BMW EfficientDynamics represents the most comprehensive package of innovative technologies currently in production, for reducing fuel consumption and emissions while simultaneously creating The Ultimate Driving Machine.®

### Different paths to the same destination: unmistakable BMW driving pleasure.

In early 2010 BMW launched its first production models with hybrid drive: the BMW ActiveHybrid 7 and the BMW ActiveHybrid X6. Both models offer an unparalleled combination of increased fuel efficiency, reduced emissions and thrilling performance. The BMW ActiveE, with its innovative 100% electric drive system, introduces a whole new form of dynamic performance, paving the way for the future of emissions-free mobility. Finally, a completely new vehicle concept targeted at meeting the need for sustainable mobility in fast-growing metropolitan areas will soon become reality: the BMW i3.

**BMW Vision EfficientDynamics: Vision becomes reality.** In 2014 BMW plans to debut the BMW Vision EfficientDynamics test model – a 2+2 sports car featuring groundbreaking plug-in hybrid technology that combines sports-car performance with compact-class consumption. Powered by the latest-generation, full-hybrid system, the vehicle – in concept form – generates a total of 328 hp through a 161-hp, three-cylinder turbo diesel engine with 214 lb-ft of torque, as well as a hybrid synchronous engine on the front axle and fully hybrid drive system on the rear axle. With a range of up to 435 miles, its ratio of performance to fuel consumption is without equal, positioning BMW as the world's leading manufacturer of exceptionally efficient, sporty vehicles.

[bmwusa.com/efficientdynamics](http://bmwusa.com/efficientdynamics)



## THE BMW X6 SPORTS ACTIVITY COUPE® EFFICIENT DYNAMICS INITIATIVE AT A GLANCE.



### BMW TwinPower Turbo technology.

Benefiting from BMW's innovative twin-scroll turbocharging technology that reclaims the energy contained in exhaust gases, the X6 engines deliver quick acceleration while virtually eliminating turbo lag.

### High Precision Direct Injection.

In this latest-generation direct fuel injection system, the piezo injectors are positioned very close to the spark plugs. They inject fuel at high pressure, with extreme precision, for very efficient combustion.

### Valvetronic.

BMW's Valvetronic valve control system improves engine response and refinement, while also helping to reduce fuel consumption. The system helps the engine "breathe" better by providing fully variable lift adjustment of the inlet valves.

### 8-speed Sport Automatic transmission.

This transmission provides extremely fast shifting in both automatic and STEPTRONIC shift modes. By increasing the number of gears to eight, the transmission provides a more efficient shifting sequence and improved fuel economy.

### Electric Power Steering.

Unlike conventional, hydraulic steering systems, electric power steering draws power only during actual steering movements. When the steering wheel position is constant, the electric motor is inactive.

### Brake Energy Regeneration.

In vehicles with Brake Energy Regeneration, the alternator normally generates electricity only when the driver takes his or her foot off the accelerator or brake pedal. Kinetic energy that was previously unharnessed is transformed into electrical energy, then fed into the battery. In this way, electricity is generated without consuming fuel.

Not all BMW EfficientDynamics features are available on all models. Please see your authorized BMW center for details.

**BMW EfficientDynamics**  
Less emissions. More driving pleasure.



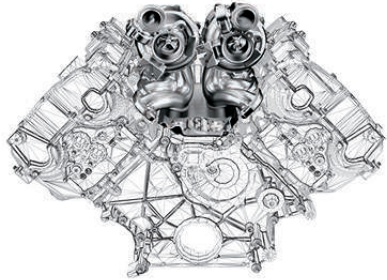

**A tale of two TwinPower Turbos:** the V-8 in the BMW X6 xDrive50i (above) delivers eager acceleration in every driving situation. The inline six-cylinder in the BMW X6 xDrive35i (right) uses Valvetronic for better breathing. BMW's High Precision Direct Injection system ensures both are highly fuel efficient with virtually no turbo lag.

## A TURBOCHARGED DRIVING EXPERIENCE IS PAR FOR THE COURSE.

Dynamic driving requires an engine that can keep up. These engine options for the BMW X6 offer plenty of muscle to go from smooth highway driving to exhilarating uphill charges, all with BMW's signature crisp acceleration and responsive powerband. You'll find the BMW X6 is capable of handling even the most challenging drives with ease.

"Turbo lag" is virtually a thing of the past, thanks to BMW's innovative use of turbocharging technology, direct injection, Double-VANOS and clean engine management software. These features also help make BMW turbocharged engines remarkably fuel-efficient.

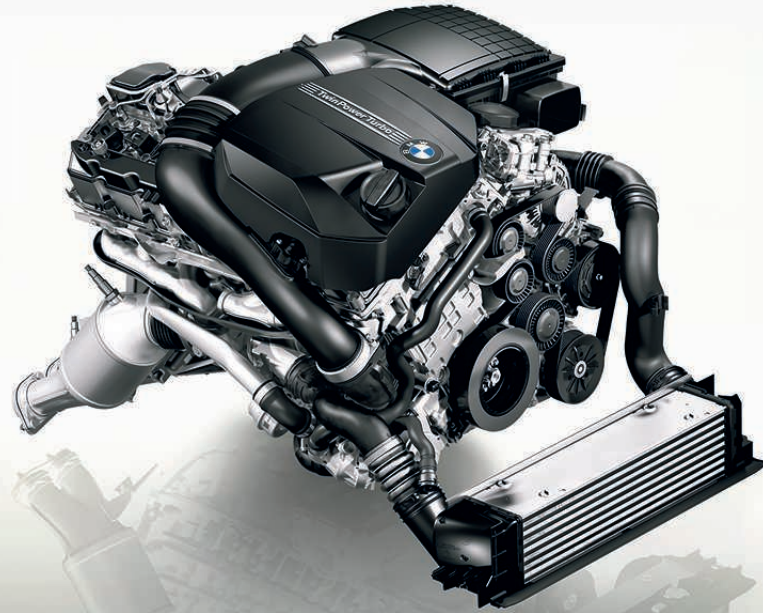

**BMW EfficientDynamics**  
Less emissions. More driving pleasure.

## THREE ADVANCED ENGINES. ONE GREAT VEHICLE. THE BMW X6.

How do you like your power? With the BMW X6, you have your choice of two combustion engines and an advanced ActiveHybrid.

**BMW X6 xDrive35i:** BMW's award-winning 3.0-liter TwinPower Turbo offers a potent 300 hp and 300 lb-ft of torque. In addition to High Precision Direct Injection, it is equipped with both turbocharging and BMW's Valvetronic throttle-less intake technology. This combination delivers improved throttle response from idle to redline, as well as reduced fuel consumption and substantially reduced emissions.

**BMW X6 xDrive50i:** For this commanding powerhouse, BMW engineers developed a V-8 that features a cutting-edge TwinPower Turbo for reliable, virtually lag-free performance and acceleration in any situation. Brawny and efficient, this 400-hp engine generates 450 lb-ft of torque to propel the BMW X6 xDrive50i from 0-60 in a scant 5.2 seconds.<sup>1</sup>

Both of these BMW X6 models channel power through an innovative 8-speed Sport Automatic transmission that delivers quick shifts, silken smoothness and enhanced efficiency. Use the sleek, ergonomically designed electronic shift knob to select Automatic with Adaptive Transmission Control, Sport, or STEPTRONIC Manual shift modes. And when the urge for racing-inspired driving excitement strikes, steering wheel-mounted paddle shifters offer quick control.

<sup>1</sup> BMW AG test results. BMW urges you to obey all posted speed laws and always wear safety belts.

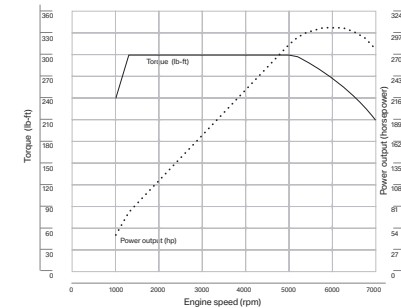

An engineering masterpiece, the BMW X6 xDrive35i TwinPower Turbo engine produces 300 hp at 5800 rpm and quickly develops 300 lb-ft of torque at 1300 rpm, which continues without fading through to the 5000 rpm range. With such a broad range of powerful torque, you can enjoy smooth, robust acceleration in any gear, at any speed.





## A FORM OF HYBRID POWER THAT'S NOTHING SHORT OF ELECTRIFYING.

Forget everything you previously thought about hybrids: that they are slow, unexciting vehicles that sacrifice fun in the name of frugality. Just as the BMW X6 is the world's first Sports Activity Coupe<sup>®</sup>, the BMW ActiveHybrid X6 features an advanced form of power poised to revolutionize the industry. This "full hybrid" combines the awe-inspiring muscle and acceleration of a BMW V-8 gasoline engine with the super efficiency of two electric motors, harnessed by a two-mode transmission. No other hybrid can surpass the BMW ActiveHybrid X6's combination of acceleration, top speed and distance. Under 40 mph, and for 1.5 miles, the electric motors can be used alone – silently and smoothly generating maximum torque from a standing start. Over 40 mph, the combustion engine takes over. Running on a combination of electric and gasoline power, the BMW ActiveHybrid X6 makes the trip from 0 to 60 in 5.4 seconds!<sup>1</sup> Yet even though it is heavier than its combustion-powered, 400-hp sibling, it achieves 20 percent greater efficiency. This is truly the "Best of Hybrid" – BMW-style.

<sup>1</sup>BMW AG test results. BMW urges you to obey all posted speed laws and always wear safety belts.

# Active Hybrid





## BMW PUTS THE “HIGH PERFORMANCE” IN “HYBRID.”

**EXPERIENCE STILLNESS WITHOUT STANDING STILL.** At speeds of up to 40 mph, the BMW ActiveHybrid X6 is able to run on electric power alone for brief periods. This occurs automatically and allows you to drive almost noiselessly – and, above all, totally emissions-free. You can hardly experience more serene driving pleasure than that.

**ARGUABLY THE BEST BRAKING POWER GENERATOR.** Brake Energy Regeneration – the principle of recuperating braking energy – is as simple as it is intelligent. Each time you apply the brakes or take your foot off the accelerator pedal, kinetic energy is released. Light braking boosts this energy generation further – which, in the BMW ActiveHybrid X6, is made available for electronic braking, as well as stored in a high-performance battery. It can then be reused by the drive system. This saves fuel while also ensuring that the energy gained while braking can be used at any time to enhance overall output.

**ACCELERATING THE EXHILARATION.** The BMW ActiveHybrid boost function is proof that enhanced efficiency can go hand-in-hand with maximum driving pleasure. With this feature, the electric motor gives a temporary – but potent – boost to the combustion engine’s output. A key advantage is that it provides spontaneous, powerful output, especially from a standing start, as well as during acceleration and when passing. As a result, the BMW ActiveHybrid X6’s performance is significantly enhanced without using more gasoline. Leave it to BMW to increase driving enjoyment while reducing consumption and emissions.

**INTELLIGENT ENERGY MANAGEMENT STARTS BEFORE YOU DO.** Every time you come to a standstill in the BMW ActiveHybrid X6, you actively save fuel, thanks to the Hybrid Start-Stop function. That’s because the engine switches off when the vehicle is stationary. This cuts fuel consumption and emissions, especially in city traffic, so you are doing a favor to both your wallet and the environment.



**Streamline (Style 297)** 20 x 10.0 front, 20 x 11.0 rear light alloy wheels with 275/40 front, 315/35 rear **run-flat performance tires**<sup>1</sup> serve to reduce unsprung weight for increased performance.

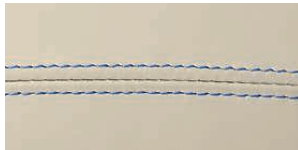

**Exclusivity that runs a blue streak:** contrasting stitching in a special blue color denotes the BMW ActiveHybrid X6 interior, underscoring its premium status.



**Special welcome:** chrome door-sill finishers give an eco-friendly greeting with “BMW ActiveHybrid” lettering.



**Power play:** a graphic in the Control Display shows the source of power flow in real time. Electric power is shown in blue; power from the combustion engine, in red.

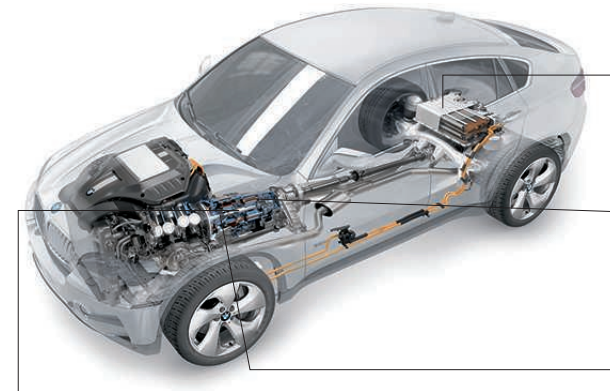

**Battery:** The high-performance nickel-metal hydride battery stored over the rear axle is powerful enough for daily use. Yet its compact design leaves ample room to stow four golf bags in the cargo area, as in the other BMW X6 models.

**Two-mode active transmission:** Thanks to this innovative technology, the electric motors and the combustion engine can be used alone or together for optimum performance. Mode 1 provides high-traction, low-speed starts, which are perfect for city driving. Mode 2, which is geared for higher speeds and highways, optimizes performance for maximum efficiency and driving excitement. The 7-speed automatic transmission delivers the BMW high-performance driving experience, with deep reserves of power always on tap. Manual gear changes can also be carried out using steering wheel-mounted gear shift paddles.

**Electric air conditioning compressor:** The electric drive of the air conditioning system runs independently of the combustion engine. You can create a comfortable climate and maintain it while driving on electric power alone – or even when the engine is switched off. This leaves more hybrid energy available for other uses, and full use of all hybrid functions – even during sporty driving and in extreme weather.

**Two electric motors:** These start the engine and, when needed, back up the combustion engine to enhance driving dynamics. In addition, the two electric motors enable the vehicle to drive on electric power alone, which contributes to a substantial cut in consumption and up to a 20 percent reduction in emissions. During Brake Energy Regeneration, the two electric motors also act as generators, storing energy for later use.

<sup>1</sup> Run-flat tires do not come equipped with a spare tire and wheel. Driving over rough or damaged road surfaces, as well as debris, curbs and other obstacles, can cause serious damage to wheels, tires and suspension parts. This is more likely to occur with low-profile tires, which provide less cushioning between the wheel and the road. Be careful to avoid road hazards and reduce your speed, especially if your vehicle is equipped with low-profile tires. Performance tires are not recommended for driving in snow and ice.





## ALL-WHEEL-DRIVE TECHNOLOGY TAKES AN INNOVATIVE NEW TURN.

Dynamic Performance Control is an advanced driving technology that made its BMW debut on the BMW X6 Sports Activity Coupe. Offered in tandem with the road-gripping control of xDrive intelligent all-wheel drive, it creates a new standard for sporty driving pleasure.

Where xDrive all-wheel drive can send available power from the rear to the front, Dynamic Performance Control smoothly apportions available power between the rear wheels. When cornering, Dynamic Performance Control sends more power to the outside rear wheel, enabling the vehicle to “turn in” with less understeer. Minimizing understeer (the tendency to plow through a turn) lets you make tight turns and corner with confidence.

Previously, cornering technologies minimized understeer by applying the brakes to the inside rear wheel, slowing the vehicle down. And unlike other manufacturers’ cornering technologies, BMW’s Dynamic Performance Control works all the time – even when you take your foot off the accelerator in corners. The result is constant control, experiencing quicker turns and improved handling for optimum performance.

Dynamic Performance Control also works in tandem with Dynamic Stability Control (DSC), to keep intervention to a minimum when accelerating out of a bend. With Dynamic Performance Control, you fully appreciate the power and performance of the BMW X6 in virtually any driving situation.

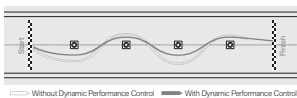

In a right-hand curve, Dynamic Performance Control applies additional power to the left rear wheel, enabling the vehicle to “turn in” faster. Because of the reduced understeer, the vehicle corners with greater control and precision.

If you’re driving straight ahead, the power is distributed evenly over both rear wheels for optimum acceleration.

In a left-hand curve, Dynamic Performance Control allocates more driving torque to the right rear wheel, enabling the vehicle to “turn in” with less understeer.

Dynamic Performance Control lets you hug corners more tightly and take them more quickly. In addition to precise control, its seamless distribution of power between the two rear wheels adds greater agility and sportiness for a thrilling driving experience.

## ACTIVE STEERING AND ADAPTIVE DRIVE: TWO GREAT WAYS TO TAME CURVES – WHEREVER YOU FIND THEM.

The goal of BMW suspension engineers is to combine sporty handling with optimum body control and ride comfort. In addition to a meticulously tuned chassis, xDrive intelligent all-wheel drive and Dynamic Performance Control, the BMW X6 offers two features that take driving response even further. Active Steering delivers greater driving enjoyment with even more direct steering when cornering, and greater agility on twisty sections of road. At low and moderate speeds, it takes just two turns of the steering wheel to move the front wheels from far left to far right. When the steering wheel is turned the same amount at higher speeds, the steering ratio gradually changes, providing greater directional stability and more comfortable cruising.

Adaptive Drive offers performance-elevating Active Roll Stabilization (ARS) and ride-enhancing Dynamic Damping Control (DDC). In corners, the vehicle’s body tends to roll, affecting handling characteristics. ARS twists specially designed two-piece anti-roll bars to generate stronger resistance to body roll, keeping the vehicle more level and providing maximum stability and agility. DDC, on the other hand, instantly and continuously adjusts the shock absorbers from the softest to the firmest settings. The result is exceptional riding comfort and fluid handling at all times, during changes in vehicle speed, load or road and driving conditions.

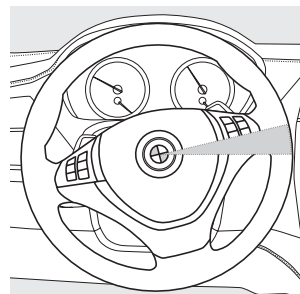

Greater agility at low and medium speeds: With Active Steering, a small turn of the steering wheel translates into a big turn of the front wheels.

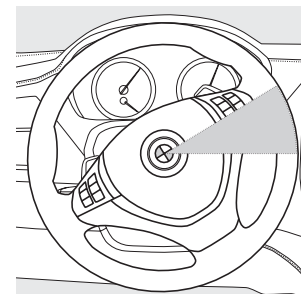

At higher speeds, greater stability and precision: A bigger turn of the steering wheel is needed to turn the front wheels.

Get the latest information on BMW standard and optional features, packages and technical specifications. Visit [bmwusa.com](http://bmwusa.com), select the BMW model of your choice, and click on “Features & Specs.”





Adaptive Headlights automatically swivel in the direction you are turning, keeping the road ahead illuminated – even around bends.

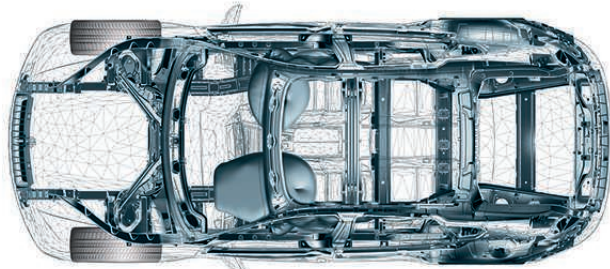

In a severe impact, the BMW X6's extremely rigid steel structure is designed to route impact forces around the passenger cell, and deform in a predetermined way. The BMW Advanced Safety System coordinates the activation of airbags, head restraints, safety-belt pretensioners and more, all helping to protect you and your passengers.

Please note: These pictures of airbags are for illustrative purposes only. Depending upon the type of accident, none, some or all airbags may deploy.

## WHEN IT COMES TO ACTIVE AND PASSIVE SAFETY, THE BMW X6 IS AN OVERACHIEVER.

As you would expect from a company committed to innovative ideas, the BMW X6 is filled with state-of-the-art safety features. "Active" safety features help you avoid getting involved in an accident. Like all BMWs, the X6 responds to your evasive maneuvers with quick acceleration, nimble handling and fade-resistant braking. During normal driving, if you slam on the brakes, **Dynamic Brake Control** applies the maximum available stopping power. At the same time, the **Adaptive Brakelights** feature automatically activates additional brakelight surfaces, signaling the intensity of your stopping action to those following you. The BMW X6 also includes a wealth of other intelligent active safety features. At night or in poor lighting conditions, **Xenon Adaptive Headlights** provide daylight-like illumination, with headlights that horizontally pivot, lighting up the road around corners. **Hill Descent Control** helps the BMW X6 tackle steep downhill slopes with ease, keeping you at a low, steady speed without riding the brake. The list of BMW X6 active safety features continues – as does your driving peace of mind.

However, should an accident prove unavoidable, the BMW X6's impressive "passive" safety features help protect you and your passengers. BMW's use of high-strength steel creates an extremely sturdy safety cage that, in a severe impact, deforms in a predetermined pattern as the force is routed around the passenger cell. High-strength structural reinforcements are integrated into all four doors to help protect occupants in a side-on collision by reducing intrusions into the passenger area. BMW's supplemental restraint system includes front-seat and seat-mounted airbags for the driver and front passenger, as well as BMW's unique **Head Protection System (HPS)** – a tubular cushion that stays inflated, helping to protect all four occupants' heads by shielding them from shattered glass and debris. The system also helps protect occupants with highly developed and coordinated restraints, such as three-point safety belts and front-seat **Active Head Restraints**.

At the end of the day, BMW believes the only thing that should set your heart beating faster is the pure enjoyment of driving a BMW X6.



## SEE EVERYTHING AT A GLANCE – INCLUDING THE ROAD.

Taking your eyes off the road, even if only to quickly check the speedometer, is a distraction. That's why BMW's Head-up Display is designed to give you important driving information at a glance. Vehicle speed, Check Control warnings, directional arrows from the Navigation system, cruise control information and more are projected clearly onto the windshield in the driver's line of sight. You can also adjust the display for brightness and height, or turn it off. The display lets you keep both eyes focused on the road, so you can navigate traffic while staying informed.

Get the latest information on BMW standard and optional features, packages and technical specifications. Visit [bmwusa.com](http://bmwusa.com), select the BMW model of your choice, and click on "Features & Specs."

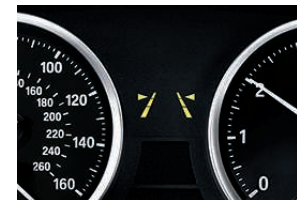

**Lane Departure Warning** feature alerts the driver by discreetly vibrating the steering wheel if the vehicle crosses lane markings without using the directional signal.

Requires clearly definable lane markings that are not obscured by rain, snow, etc. Lane Departure Warning feature is not a substitute for the driver's own responsibility in maintaining safe control of the vehicle.

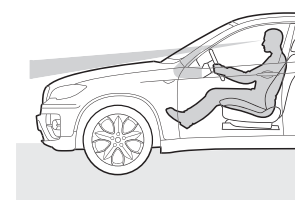

The **Head-up Display** shows relevant information, such as the car's speed, directly into the driver's field of vision. The height-adjustable display helps keep you focused on what's happening on the road.

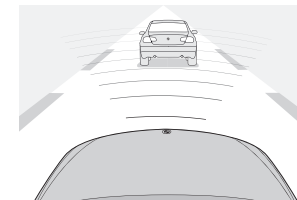

**Active Cruise Control with Stop & Go** uses radar measurements to automatically maintain a preset speed and distance between your vehicle and the one ahead.

Active Cruise Control is not a substitute for the driver's own responsibility in adjusting speed and otherwise controlling the vehicle. After evaluating road, traffic and visibility conditions, the driver must determine whether and how the system is used.



## STAY TOTALLY IN TOUCH WHEREVER YOU GO – WITH BMW CONNECTED DRIVE.



Whether you're far from home or just in the next town, BMW Assist™ offers convenience and peace of mind. There are new ConnectedDrive features that extend BMW's leadership in wireless communications. Marvel at an extensive array of new Mobile Office functions. Get a visual image of your callers. With BMW Assist, you enjoy all this – and more.

**BMW Assist** gives you peace of mind knowing that a friendly response specialist is there to help you 24/7, at the touch of a button. The **Safety Plan** includes Automatic Collision Notification, Emergency Request (SOS), TeleService, Enhanced Roadside Assistance, Door Unlock, Stolen Vehicle Recovery, Customer Relations and MyInfo. The **Convenience Plan** adds personalized Directions, Traffic and Weather reports, BMW Online and Concierge services for restaurant and hotel recommendations, with the destination address and phone number sent to your BMW. Make up to four operator-assisted calls per year with Critical Calling if your mobile phone is not available or its battery is discharged.

Use the time you spend in your vehicle even more effectively with BMW's **Mobile Office** feature! For example, when your vehicle is paired with a selected Bluetooth® interface, text messages and emails are transferred to your iDrive Display screen – and our system even reads them aloud to you. Thanks to Bluetooth audio streaming, you can enjoy wireless playback of your music files; your personal audio library can even be accessed via the iDrive Controller.

<sup>1</sup> Not all mobile phones are compatible with Mobile Office, and some compatible phones support a limited number of Mobile Office functions. For the complete list of compatible mobile phones and the details regarding which Mobile Office functions are supported by each phone, please visit [bmwusa.com/bluetooth](http://bmwusa.com/bluetooth).

What's on today's agenda? Bring up the **Calendar** and **To-do List** on your Display screen while en route, to help you stay on schedule. Need to call your 11 o'clock appointment? Use the iDrive Controller knob to **click on the phone number** in the Calendar – and it's ringing. Meeting with several people? Conduct conference calls; the Display screen keeps you informed of the status of incoming calls. Who's calling you? If you've uploaded photos to your on-board phonebook, you'll see the caller's picture. Even missed calls are listed on the Display screen. It's never been easier to stay in touch while in transit.

**Enhanced functions** for the iPod® and USB adapter add to the ease and pleasure of using your iPod or iPhone®. Want to know which CD that song comes from? The album cover is shown on your Display screen. Don't purchase additional cables – your iPod or iPhone's original USB cable connects to your BMW's USB port. Another rare feature: with BMW Assist and Bluetooth audio streaming, you can wirelessly play music through the BMW audio system from any Bluetooth compatible music player or mobile phone, from anywhere in your vehicle. In fact, the audio library appears on the Display screen, where you can use the iDrive Controller knob to make your selection.

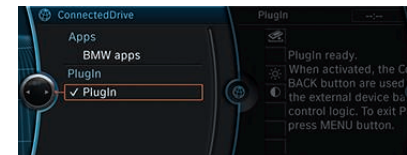
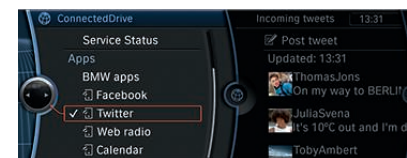
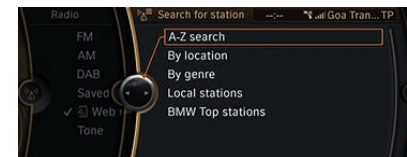
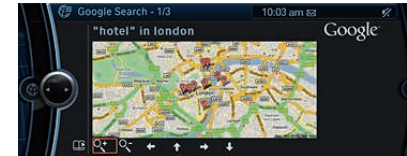
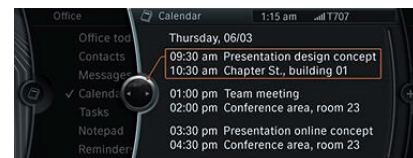

[bmwusa.com/connecteddrive](http://bmwusa.com/connecteddrive)

**MyInfo** allows you to send business locations and street addresses to your BMW from Google Maps.™ Destinations and phone numbers can be accessed and exported to your Navigation system for immediate route guidance, while you can call the destination with your Bluetooth linked phone.

**BMW Online** allows online access to up-to-date fuel prices and gas station locations; the latest weather forecasts, advisories and warnings; Dow Jones, S&P 500 and NASDAQ indices; and the powerful reach of the Google Maps database – all delivered on the Control Display inside your vehicle. Access news headlines and have them read aloud via Text-to-speech technology. "Send to Mail" pinpoints your current location and planned destination, and allows you to send the information to any smartphone or email account. Then it's just a quick hyperlink to Google Maps for your friends and family to see where you are and where you're going.

**BMW Apps** lets you access Social Networks, music PlugIn and Video Playback through your iPhone, and see them on the Display screen.<sup>2</sup> Tune in to **Web radio** and search for stations from around the globe by name, location or genre. You can also store your favorite stations, find similar stations, display station information, and change the quality of the audio. Your favorite entries are stored on your iPhone, so you can take them with you from one vehicle to another.

Please note:   
 • Available in models manufactured as of April 2011.   
 • Not all features available while vehicle is in motion; see dealer for details.   
 • Web radio audio quality depends on the bit rate of the station, and data reception depends on your cell service. Data transfer comes over the iPhone.

Access content from your **Twitter™** and **Facebook®** accounts to stay on top of what's happening with friends and family.<sup>2</sup> The system can even read posts aloud, so you can keep your focus on the road. You can quickly post prewritten tweets that are further personalized by your BMW to let everyone know where you are and that you're enjoying the drive.

When you select **Plugin** from the BMW Apps menu, the iPhone exports a typical iPod look and control to your BMW through the video connection.<sup>2</sup> You can then search for your favorite music by playlist, artist, album, song, genre or composer, just as you would on your iPhone.

Please note: The BMW App must be installed on your iPhone for the Plugin to connect.

<sup>2</sup> Requires BMW Apps option and an iPhone.

Get the latest information on BMW standard and optional features, packages and technical specifications. Visit [bmwusa.com](http://bmwusa.com), select the BMW model of your choice, and click on "Features & Specs."



## Paints.

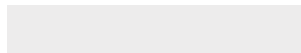

300 Alpine White Non-metallic



668 Jet Black Non-metallic



354 Titanium Silver Metallic



475 Black Sapphire Metallic



A14 Mineral Silver Metallic



A35 Monaco Blue Metallic



A52 Space Gray Metallic



A76 Deep Sea Blue Metallic



A81 Tasman Green Metallic



A82 Vermilion Red Metallic



BMW Individual



X02 Citrin Black Metallic



X03 Ruby Black Metallic



S34 Azurite Black Metallic



X01 Pearl Silver Metallic

## Upholsteries.



GHSW Black Alcantara/Leather combination



GHCH Chateau Alcantara/Leather combination

Please refer to the Recommended color combinations chart on page 35 for details on limitations and exclusivity when selecting upholstery materials and colors.



LUSW Black Nevada Leather



LUB4 Sand Beige Nevada Leather



LUD3 Saddle Brown Nevada Leather



LUCH Chateau Nevada Leather



LUCX Oyster Nevada Leather



LVSW Black Perforated Nevada Leather



LVB4 Sand Beige Perforated Nevada Leather



NASW Black Nappa Leather

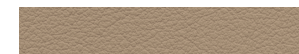

NAB4 Sand Beige Nappa Leather



NANW Ivory Nappa Leather



BMW Individual



ZBC8 Platinum Full Merino Leather



ZBCM Champagne Full Merino Leather



ZBP3 Criollo Brown Full Merino Leather

The pages in this section of the brochure show available colors and materials for the BMW X6. Use these samples to compare paint, upholstery, trim colors and combinations. Please note that these samples are representations; they are not exact reproductions. To see the actual colors, visit your authorized BMW center. They will be happy to show you original samples and assist you with special requests.



## Interior trims.



4AD Brushed Aluminum



4AZ Dark Bamboo Wood



4BN Ash Grain Wood



BMW Individual



XE9 Carbon Leather Wrapped



XE3 Eucalyptus Red Brown Wood



XE7 Piano Black

## Recommended color combinations.

													BMW Individual <sup>2</sup>		
Upholstery materials	Alcantara/Leather combination <sup>1</sup>		Nevada Leather <sup>2</sup>					Perforated Nevada Leather <sup>3</sup>		Nappa Leather <sup>4</sup>			Full Merino Leather		
Upholstery colors	Black	Chateau	Black	Sand Beige	Saddle Brown <sup>5</sup>	Chateau <sup>5</sup>	Oyster	Black	Sand Beige	Black	Sand Beige	Ivory <sup>6</sup>	Platinum	Champagne	Criollo Brown
<b>BMW exterior colors</b>															
300 Alpine White Non-metallic	•	•	•	•	•	•	•	•	•	•	•	•	•	•	•
668 Jet Black Non-metallic	•	•	•	•	•	•	•	•	•	•	•	•	•	•	•
354 Titanium Silver Metallic	•	•	•	•	•	•	•	•	•	•	•	•	•	•	•
475 Black Sapphire Metallic	•	•	•	•	•	•	•	•	•	•	•	•	•	•	•
A14 Mineral Silver Metallic	•	•	•	•	•	•	•	•	•	•	•	•	•	•	•
A35 Monaco Blue Metallic <sup>2</sup>	•	•	•	•	•	•	•	•	•	•	•	•	•	•	•
A52 Space Gray Metallic	•	•	•	•	•	•	•	•	•	•	•	•	•	•	•
A76 Deep Sea Blue Metallic	•	•	•	•	•	•	•	•	•	•	•	•	•	•	•
A81 Tasman Green Metallic	•	•	•	•	•	•	•	•	•	•	•	•	•	•	•
A82 Vermilion Red Metallic	•	•	•	•	•	•	•	•	•	•	•	•	•	•	•
<b>BMW Individual exterior colors<sup>2</sup></b>															
X02 Citrin Black Metallic	•	•	•	•	•	•	•	•	•	•	•	•	•	•	•
X03 Ruby Black Metallic	•	•	•	•	•	•	•	•	•	•	•	•	•	•	•
S34 Azurite Black Metallic	•	•	•	•	•	•	•	•	•	•	•	•	•	•	•
X01 Pearl Silver Metallic	•	•	•	•	•	•	•	•	•	•	•	•	•	•	•
<b>BMW interior trims</b>															
4AD Brushed Aluminum	•	•	•	•	•	•	•	•	•	•	•	•	•	•	•
4AZ Dark Bamboo Wood	•	•	•	•	•	•	•	•	•	•	•	•	•	•	•
4BN Ash Grain Wood	•	•	•	•	•	•	•	•	•	•	•	•	•	•	•
<b>BMW Individual interior trims<sup>2</sup></b>															
XE9 Carbon Leather Wrapped	•	•	•	•	•	•	•	•	•	•	•	•	•	•	•
XE3 Eucalyptus Red Brown Wood	•	•	•	•	•	•	•	•	•	•	•	•	•	•	•
XE7 Piano Black	•	•	•	•	•	•	•	•	•	•	•	•	•	•	•

<sup>1</sup> Requires and must be ordered with optional sport seats.

<sup>2</sup> Not available in Active-Hybrid X6.

<sup>3</sup> Requires and must be ordered with optional Active Ventilated Seat Package.

<sup>4</sup> Includes Nappa Leather-covered dashboard and center console; requires multi-contour seats in X6 xDrive35i; standard in ActiveHybridX6.

<sup>5</sup> Requires multi-contour seats in X6 xDrive35i.

<sup>6</sup> Not available in X6 xDrive35i and X6 xDrive50i.





## HEART OF FIRE.

Outside: timeless Jet Black paint and 20-inch Y Spoke (Style 214) wheels. Inside: the glow of red Chateau Nevada Leather against the black dash and carpeting. Like the fire within the coal, this BMW X6 visually smolders, ready to ignite the passion of anyone who comes near.

Get the latest information on BMW standard and optional features, packages and technical specifications. Visit [bmwusa.com](http://bmwusa.com), select the BMW model of your choice, and click on "Features & Specs."







The flexible cargo space of the BMW X6, with 60/40 split-folding rear seats and available pass-through, maximizes your hauling possibilities.



The storage package adds two lashing rails with four sliding lashing eyes, as well as additional lighting, making it easy to see and secure cargo safely and quickly.



With both rear seats lowered, the BMW X6 provides almost 60 cu. ft. of usable storage space.

## PLENTY OF ROOM FOR ALL THAT MATTERS.

The BMW X6 was created with a spacious, flexible cargo area that carries your gear with ease. In addition to 60/40 split-folding rear seats and a retractable cargo cover, an available pass-through with ski bag helps protect skis, poles and other long items, as well as the interior. A storage package adds additional lighting and two lashing rails with four sliding lashing eyes. So feel free to bring along some friends and their gear – the BMW X6 can handle it.

Get the latest information on BMW standard and optional features, packages and technical specifications. Visit [bmwusa.com](http://bmwusa.com), select the BMW model of your choice, and click on "Features & Specs."



**Xenon Adaptive Headlights** help enhance nighttime road visibility. Sensors continuously monitor the steering wheel to determine the vehicle's direction. Entering a turn or corner, the outer headlights swivel up to 15 degrees left or right. **Xenon low- and high-beam headlights** illuminate the road ahead and to the side with brilliant clarity. An auto-leveling feature adjusts for varying passenger and cargo loads. **Corona headlight-rings** circle headlights and high beams and act separately as Daytime Running Lights.



**Halogen free-form foglights** are cleanly integrated into the front air dam, illuminating the road ahead in bad weather and poor visibility. They also provide another practical feature: **Cornering Lights**. When the system senses you are making a turn – based on your steering angle and speed – a reflector mechanism in the foglight housing casts additional lighting up to 90 degrees in the direction of the turn. This enhances visibility and recognition of people and objects.



**Adaptive Brake Lights** increase vehicle visibility and signal the intensity of your braking action, thereby warning following drivers to brake quickly.



**Retractable, high-intensity headlight washers** help keep lights clean of ice, mud, road salt and other coatings, for maximum road lighting and enhanced driving visibility.



**Dual circular-shape chrome exhaust tips**, integrated into the BMW X6 xDrive35i's rear fascia, stand out and add an attractive touch to the exhaust system.



**Star Spoke (Style 232)** 19 x 9.0 light alloy wheels with 255/50 **run-flat<sup>1</sup> all-season tires.**



**V Spoke (Style 257)** 19 x 9.0 light alloy wheels with 255/50 **run-flat<sup>1</sup> all-season tires.**



**Star Spoke (Style 212)** 19 x 9.0 light alloy wheels with 255/50 **run-flat<sup>1</sup> all-season tires.**



Signature **kidney grille** sits over the special intake grille, underscoring the BMW X6's rugged stance. (Kidney grille has black finish on BMW X6 xDrive35i; Titanium finish on BMW X6 xDrive50i and ActiveHybrid X6.)



**Body-color, power-adjustable folding side-view mirrors** automatically dim when reflecting bright lights, helping to eliminate glare when driving at night.



**Running boards**, designed to add to the BMW X6's overall visual appeal, make it easy for passengers to comfortably enter and exit.



**Dual rectangular-shape chrome exhaust tips** are strikingly positioned in the rear fascia of the BMW X6 xDrive50i and ActiveHybrid X6. With their bold styling, these exhaust tips identify the models with the V-8 engines.



**Star Spoke (Style 258)** 19 x 9.0 light alloy wheels with 255/50 **run-flat<sup>1</sup> all-season tires.**



**Y Spoke (Style 214)** 20 x 10.0 front, 20 x 11.0 rear light alloy wheels with 275/40 front and 315/35 rear **run-flat<sup>1</sup> performance tires.<sup>2</sup>**



**Y Spoke (Style 336)** 20 x 10.0 front, 20 x 11.0 rear light alloy wheels with 275/40 front and 315/35 rear **run-flat<sup>1</sup> performance tires.<sup>2</sup>**



**Streamline (Style 297)** 20 x 10.0 front, 20 x 11.0 rear light alloy wheels with 275/40 front and 315/35 rear **run-flat<sup>1</sup> performance tires.<sup>2</sup>**

<sup>1</sup> Run-flat tires do not come equipped with a spare tire and wheel.

<sup>2</sup> Driving over rough or damaged road surfaces, as well as debris, curbs and other obstacles, can cause serious damage to wheels, tires and suspension parts. This is more likely to occur with low-profile tires, which provide less cushioning between the wheel and the road. Be careful to avoid road hazards and reduce your speed, especially if your vehicle is equipped with low-profile tires. Performance tires are not recommended for driving in snow and ice.





**Three-spoke leather-wrapped multi-function sport steering wheel**, featuring power tilt/telescoping adjustments, lets you keep both hands on the steering wheel while adjusting both the audio and a BMW-approved, Bluetooth® enabled mobile phone.



**Voice command** lets you verbally control numerous Navigation system functions and dial phone numbers hands-free. The Voice command button must be pressed before each use, so conversations won't accidentally activate the phone or other systems. (Voice command is part of the Navigation system.)



**Engine Start/Stop button and remote key** control the engine. First, insert the remote key into the starter switch slot. After the electronic identification system confirms that it is the correct remote, you can start (or later, turn off) the engine by pressing the Start/Stop button. (Foot must be on brake in order to start.)



**iDrive Controller**, which is conveniently located on the center console, is the central command element for the iDrive system and can be rotated, pushed and tilted to operate various functions via the Control Display. Additionally, four frequently selected menus – CD, radio, Navigation system and telephone – can be called up using direct menu-control buttons.



**Six programmable memory buttons** offer convenient storage of your most frequently accessed iDrive settings, such as favorite radio stations, Navigation system addresses, phone numbers (when equipped with a BMW-approved Bluetooth enabled mobile phone), and more.



**Navigation system** features a high-resolution glare-free monitor and uses GPS satellites in conjunction with data stored on an internal hard drive. Includes 3-D daytime and nighttime maps, zoom, travel planner and an Assistance Window. The system provides Real Time Traffic Information on potential traffic problems and solutions. The hard drive offers 12 GB of space that can hold up to 2,000 of your favorite songs.



**Rear-view Camera with Top View** is automatically activated by shifting into reverse gear, or manually by pressing the Parking Assist button. The color display shows a real camera image that may include "static" and "track" lines to help you when backing up or parallel parking.



**Park Distance Control** uses eight sensors – four in the front, four in the rear – to help you judge how close you are to other vehicles and unseen objects when parking. The warning beeps come faster as the bumper approaches the object, turning into a constant tone when the distance is less than 12 inches.



**Active Cruise Control (ACC) with Stop & Go** lets you preset desired speed and following distance. When ACC recognizes slower vehicles ahead, it reduces your speed to maintain the preset distance. Stop & Go can bring you to a complete stop if traffic calls for it. When you press the accelerator, ACC resumes speed according to your presets.

Cruise control is not a substitute for the driver's own responsibility in adjusting speed and otherwise controlling the vehicle. After evaluating the road, traffic and visibility conditions, the driver must decide whether and how the system is used.



**8-speed Sport Automatic transmission** provides extremely fast synchronized shifting, whether performed by the Automatic shift mode or by the race-inspired steering wheel-mounted paddle shifters.



**Electromechanical parking brake with Automatic Hold** keeps the vehicle stationary whenever the vehicle comes to a stop, then releases the brake when the driver steps on the accelerator pedal.



**Front cupholders** integrated into the center console are located within convenient reach of the driver and front passenger.



**Side-view Cameras** offer visual assistance when side visibility is limited, such as when exiting a parking garage or parking space. One camera is located on each front fender, just ahead of the wheel arches.



**Head-up Display** projects important travel information, such as current speed, on the windshield directly in the driver's line of vision. Directional arrows from the Navigation system and Check Control data can also be displayed.



**BMW anti-theft AM/FM stereo CD/MP3 player** includes Radio Data System, Auto-Store, and 3-channel FM diversity antenna; reads/displays song title. **HD Radio™** receives free, digital AM/FM broadcasts in clear, static-free sound; multicast FM stations, and innovative data services.



**Kneepads** along the sides of the center console provide greater comfort and grip for the driver and front passenger's knees – especially during quick, sharp turns.



**Storage space** abounds throughout the cabin – in the front center console, in door storage pockets and in the rear cabin.



**Ten-way power front sport seats** with two-way manual thigh support adjustment and driver's seat memory system make the BMW X6 driving experience more enjoyable. Thanks to specially padded, highly contoured side bolsters, sport seats provide optimum lateral support during tight cornering, while remaining exceptionally comfortable when driving over long distances. The seats have power adjustments for seat height, backrest angle, seat bottom angle, forward/backward position and head-restraint height; includes manual adjustment for thigh support.



**Heated front seats** are a welcome feature in cooler weather. With the touch of a button, driver and front passenger can individually select from three heat settings.



**Heated steering wheel** is a feature that, like heated seats, becomes a "must-have" once it's experienced. The heating switch is conveniently located on the multi-function steering wheel.



**Front seat ventilation** gently blows warm air or cool air through the microperforations in the leather to help keep driver and front passenger comfortably dry in hot weather, and warm in colder weather.



**Active driver's seat** helps decrease stiffness or fatigue on long trips. When activated, the driver's seat surface is continuously and imperceptibly raised and lowered from side to side, keeping your spine in motion and exercising various support muscles.



**Four-zone climate control** lets occupants, both front and rear, select individual temperature and fan settings.



**Five-seat configuration** is available on request. It features three head-restraints in the rear, three-point safety belts for all seats and integrated belt catches for the outer seats.



**20-way power multi-contour front seats** conform to your body to provide optimum support and exceptional comfort over long distances. In addition to horizontal, vertical and angled adjustments, seats include an articulated upper backrest, backrest width, Comfort headrest (two-way power, two-way manual "relax headrest"), and four-way power-adjustable lumbar support. Both driver's and front-passenger's seats include memory function.



**Power seat adjustments** allow customized comfort for driver and front passenger. On the driver's side, a two-driver memory system automatically adjusts the driver's seat, side-view mirrors and the steering wheel position.



**Lumbar support** for front seats adds four-way power-adjustable comfort for the lower back. Lumbar support can be adjusted up/down and in/out.



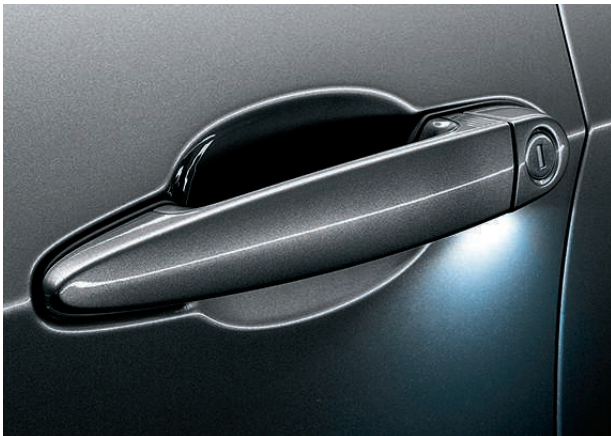

**Ambiance lighting package** includes lights in the exterior door handles that radiate downward whenever the doors are unlocked. They illuminate the area outside the doors for approximately 20 seconds to enable safe vehicle access in the dark. Also included are rear reading lights, rear footwell illumination, and Ambiance interior lighting.



**Rain sensor** uses infrared light to measure the amount of rain. When the wipers are in the "intermittent" mode, the rain sensor automatically adjusts the windshield-wiping interval as needed.

**Automatic headlight control**, included with rain sensor, activates headlights by means of a sensor that responds to darkness.



The **automatic-dimming inside rear-view mirror** darkens in response to the bright headlights of vehicles behind you. The easy-to-read **digital compass**, integrated into the mirror, is a convenient way to constantly keep your bearings while driving.

A **three-button Universal garage-door opener** can be programmed to open garage doors and activate various remote convenience functions.



**Sirius satellite radio** delivers the most innovative satellite radio sports, news/talk, traffic/weather, entertainment, and 100% commercial-free music – delivered coast to coast in crystal-clear digital sound, 24/7. "The Best of XM" offers additional premium programs. Select Sirius channels through the iDrive system or Voice command, and enter them into the programmable memory buttons.



**Privacy glass** in the rear and rear side windows enhances passenger privacy, while it reduces sun glare and interior heat.



**High-gloss shadowline trim** gives the front and rear side-window frames and door-sill trim strips a sportier look.

**Soft-close automatic doors** use small electric motors to gently close all four doors and the tailgate. Simply close the door or tailgate gently and then the electric mechanism draws it fully in.



**Two-way power glass moonroof** with remote, expanded one-touch operation, slides back or tilts up to let in as much fresh air and sky as you like, while a wind deflector helps keep the wind out. Includes a sliding interior sunshade.



**Rear side sunshades** keep the sun's heat and glare away from the rear cabin while maintaining privacy. When not in use, these manually adjustable sunshades conveniently disappear into the side doors.



**Ski bag** allows for clean transport of up to four pairs of skis with up to four occupants in the vehicle. Whenever the ski bag is not in use, it remains stored conveniently and discreetly behind the rear center armrest.



**iPod® and USB adapter** lets you scroll through and select music by using the radio controls, the multi-function steering wheel buttons or the iDrive Controller. Music titles are displayed on the radio or screen.

**Auxiliary input port** lets you connect an external audio source, such as an iPod or MP3 player.



**Premium high-fidelity system** is a multi-channel system that outputs reproduction of the surround information contained in the stereo signal in a nine-channel format (seven medium-high-range channels and two central bass channels). The 16-speaker system is comprised of one center bass speaker subwoofer below each front seat; one midrange and one high-range speaker each in the door trim panels; one midrange and one high-range speaker each in the D-pillar; one midrange and one high-range speaker in the instrument panel (center channel); and a digital amplifier with nine channels and 600-watt output (7x50 watts + 2x125 watts). All speakers are fitted with very strong, yet compact Neodymium drives. The system also compensates for driving noise in smooth steps by speed-dependent equalizing in the low range.

## BMW INDIVIDUAL. THE MOST EXCLUSIVE WAY TO DRIVE A BMW.

For those who dream of a vehicle that reflects their own unique personality, there is BMW Individual. This collection of iridescent paints, sumptuous leathers and exquisite trims takes the BMW Individual

X6 to all-new heights of quality and exclusivity. And only the finest, perfectly matched materials are selected to create each expertly handcrafted interior.

### BMW Individual paint finishes: a shade more brilliant. Several thousand shades, in fact.

BMW Individual exterior colors are noted for their brilliant, iridescent effects. One dramatic example is the Ruby Black Metallic paint finish. Under the light, it develops a dark red luminosity that seems to emanate from countless ruby pigments. Watching a BMW Individual X6 in Azurite Black Metallic move through light and shadow is reminiscent of being at sea, as the deep blue swells reflect and hide the sun. Citrin Black Metallic combines black-tie elegance with the warmth of golden light. And Pearl Silver Metallic evokes the shimmering, luminous beauty of pearls.

### BMW Individual Full Merino Leather: true exclusivity is a tangible phenomenon.

BMW Individual Full Merino Leather looks enticingly soft and velvety, and feels sumptuous. Its secret lies in a painstaking selection process: only absolutely flawless hides are approved for use.

As a result, these premium leathers do not require surface treatment. By leaving the leather in its natural state, it retains its breathable, porous structure, remaining soft and supple. All the available Full Merino Leather colors in the BMW Individual X6 – Platinum, Champagne, and Criollo Brown – are designed to complement and harmonize with BMW Individual paint finishes.

### BMW Individual interior trims: top-class craftsmanship for the finishing touch.

BMW Individual trims have a magic all their own. Whether you choose Carbon Leather Wrapped, Eucalyptus Red Brown Wood or Piano Black trim, our strict selection process and perfect finishing techniques ensure excellent quality. In creating the Piano Black interior trim, for example, superior craftsmanship is an essential ingredient. In fact, its brilliant, high-gloss surface is the result of a special process usually applied only by the world's leading piano makers.



**60/40 split-folding seat** gives you the flexibility to carry any combination of cargo and passengers.



**Retractable cargo cover** keeps contents of the cargo area hidden from sight. When not in use, it can easily be removed.



**12V power outlets** are included in the front and rear passenger areas, as well as in the cargo area.



**Rear-seat entertainment system** lets passengers in the rear cabin watch DVDs or listen to their choice of CDs through headphones or the vehicle speaker system. The system features a fold-down 8-inch color screen and can be controlled via a wireless remote or manually by rear-seat passengers.



**Rear cupholders** are conveniently located between the two rear seats. When not in use, they can be easily covered up to form a center armrest.



**Comfort Access system** offers an even greater degree of convenience: keyless access to your vehicle. Simply carrying the remote key in a pocket allows you to unlock the doors by touching the door handle. You can also turn the engine on or off by pressing the Start/Stop button without inserting the remote key. (Foot must be on brake in order to start.)



**Storage package** adds practical extras: additional lighting and two lashing rails with four sliding lashing eyes.



Created by a special five-layer paint process, the subtle iridescence of the Pearl Silver Metallic exterior artfully shows off the lines of the BMW Individual X6.



A cabin upholstered in Platinum Full Merino Leather and trimmed with Eucalyptus Red Brown Wood creates a serene travel environment.



A tour de force of Old World craftsmanship: Champagne Full Merino Leather upholstery.



Sumptuous Criollo Brown Full Merino Leather adds a rich note to the interior.



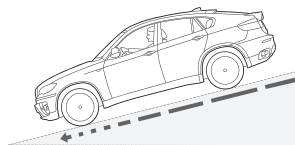

**Hill Descent Control (HDC)** helps the BMW X6 drive down steep hills without having to “ride the brake.” By pressing the HDC button, the system keeps the vehicle’s speed under control automatically.

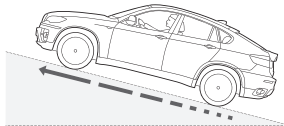

**Start-off Assistant** keeps the BMW X6 from rolling either backward or forward when you’re stopped on a hill. The system momentarily holds the vehicle’s position as you take your foot off the brake pedal and start driving.

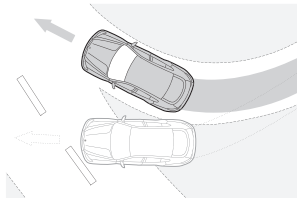

**Dynamic Stability Control** provides remarkable tenacity on slippery road surfaces. If the system senses over- or understeer, it modulates engine power and can apply brakes individually to help keep the vehicle under control and going in the intended direction.

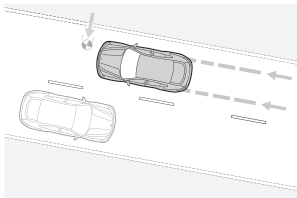

**Dynamic Brake Control** senses “panic” braking maneuvers, and immediately builds up maximum brake pressure. This cuts down the overall braking distance significantly. When Dynamic Brake Control is activated, the system also deploys **Adaptive Brakelights**. These increase vehicle visibility and signal the intensity of your braking action, thereby warning following drivers to brake quickly.

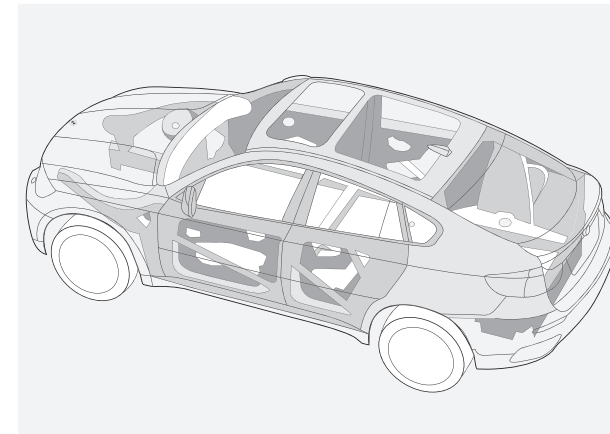

**Extremely rigid body** creates a protective safety cell that directs severe impact forces around the passenger compartment. Thanks to BMW’s intelligent lightweight design and the use of high-strength steels, the interior passenger compartment is surrounded by a remarkably strong shell.

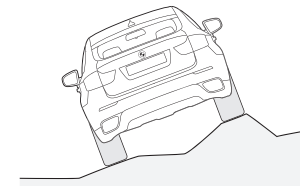

**Rollover sensor**, linked with the Dynamic Stability Control system, quickly detects when the BMW X6 is at risk of rolling over and assists the driver in maintaining control of the vehicle. If a rollover is imminent, the airbags and the safety-belt pretensioners are immediately triggered to provide additional occupant protection.

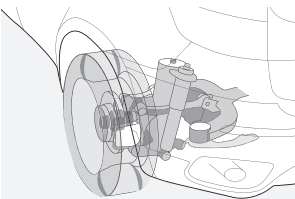

**Tire Pressure Monitor** is an electronic control system designed to warn the driver if there is a sudden and irregular loss of tire pressure. Should the target pressure of a tire fall below 25%, a warning light alerts the driver.

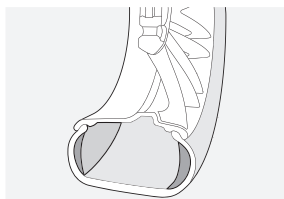

**Run-flat tires** allow speeds of up to 50 mph and travel from 30 to 150 miles after a loss of air pressure, depending on the passenger load and weight of articles being transported. In situations that would normally result in a flat tire, reinforced sidewalls help prevent the tires from collapsing or loosening from the rim. In the event of a decline in tire pressure, the driver is warned by the **Tire Pressure Monitor**.

Please see your Owner’s Manual for more information detailing allotted miles to travel and load weight rules.

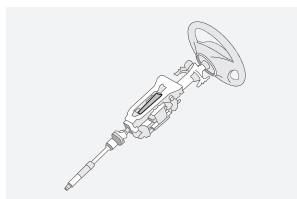

**Telescoping steering column system.** In a collision, a section absorbs a portion of the impact force and collapses, helping to protect the driver.

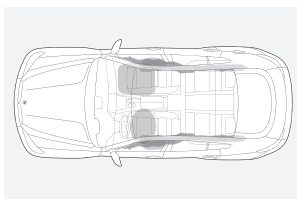

In the event of a collision, only the **airbags** that are needed are deployed. This includes front airbags with advanced deployment technology, front side-impact airbags, and front and rear HPS (Head Protection System).

Note: These pictures of airbags are for illustrative purposes only. Depending upon the type of accident, none, some or all airbags may deploy.

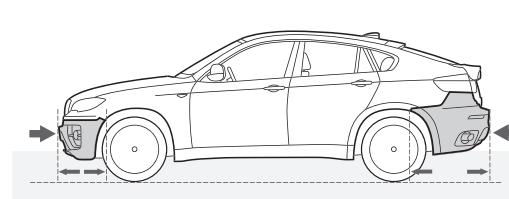

**Impact-absorbing bumpers** and compressible “crush tubes” front and rear help absorb the force of impact in collisions up to nine mph, minimizing damage to the vehicle’s body and simplifying repairs. Only at higher impact speeds do structural supports begin to deform, dissipating impact energy to help protect occupants.

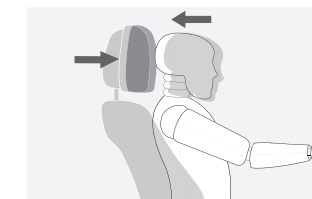

**Active Head Restraints** in the front seats reduce the risk of whiplash or neck/head/spine injury. When sensors detect a rear-end collision, the headrests rapidly and automatically pivot forward, supporting the driver’s and front-seat occupant’s heads.

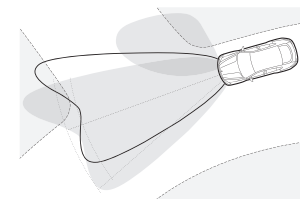

**Xenon Adaptive Headlights** with Corona headlight-rings automatically swivel to follow the curves of the road. The system uses data from on-board sensors and the steering wheel angle to determine the vehicle’s direction, then adjusts the headlights accordingly, for excellent nighttime vision.

**Cornering Lights**, integrated into each of the foglight housings and activated whenever the BMW X6’s turn-signal indicators are used, project additional lighting and increased illumination in the direction of the turn.

## CRAFT YOUR OWN BMW – AT BMWUSA.COM/BYO.



At BMW, we want you to create your own Ultimate Driving Machine®. That's why BMW offers one of the widest model ranges of any luxury automotive manufacturer. And each BMW model offers its own universe of personalizing possibilities.

It's easy to get the latest information on your favorite BMW model. Simply visit [bmwusa.com](http://bmwusa.com) and click on the BMW model of your choice. Select **"Features & Specs"** to see all the standard features and available options and packages, as well as technical specifications.

Then create the exact BMW model that fulfills your needs by clicking on **"Build Your Own"** – or just visit [bmwusa.com/byo](http://bmwusa.com/byo). Here you'll be able to select from among the many interior and exterior colors and trims, personalizing options and value-added packages. Build a BMW model that reflects your style, then view it in 360° detail. At the press of a button, see payment and financing options, get a same-day quote, download a product brochure and even schedule a test drive. BMW makes it easier than ever to make your ultimate driving dreams come true, at [bmwusa.com](http://bmwusa.com).

Weight		X6 xDrive35i	X6 xDrive50i	ActiveHybrid X6
Unladen weight	lbs	4784	5225	5765
Weight distribution, front/rear	%	49.8/50.2	51.1/48.9	51.1/48.9

Engine		3.0-liter TwinPower Turbo inline 6	4.4-liter TwinPower Turbo V-8	4.4-liter TwinPower Turbo V-8
Liters/type				
Bore/stroke	inch	3.31/3.53	3.50/3.48	3.50/3.48
Nominal output/rpm	hp	300/5800	400/5500-6400	480/5500-6400
Maximum torque/rpm	lb-ft	300/1300-5000	450/1750-4500	450/1750-4500

Transmission				
Automatic gear ratios	I / II / III / IV	:1	4.71/3.14/2.11/1.67	4.71/3.14/2.11/1.67
	V / VI / VII / VIII / R	:1	1.29/1.00/0.84/0.67/3.30	1.29/1.00/0.84/0.67/3.32
Final drive ratio		:1	3.15	3.15
				3.64

Performance				
Drag coefficient	C <sub>d</sub>	0.35	0.37	0.36
Top speed <sup>1</sup>	mph	130 [150]	130 [150]	130
Acceleration 0-60 mph <sup>2</sup>	sec	6.3	5.2	5.4

Fuel consumption <sup>3</sup>				
City / highway	mpg	16/23	14/20	17/19
Approx. tank capacity	gal	22.5	22.5	22.5

Tires, wheels and brakes				
Tire dimensions and type of run-flat tire <sup>4</sup>	standard	255/50 all-season	255/50 all-season	275/40 front, 315/35 performance <sup>5</sup>
Wheel dimensions/material	standard	19 x 9.0/light alloy	19 x 9.0/light alloy	20 x 10.0 front, 20 x 11.0 rear / light alloy
Brakes, front/rear	inch	13.7/13.6	14.4/13.6	15.1/13.6

All-season tires limited to 130 mph. Figures in [ ] refer to Sport Package or Sport Activity Package with optional 20-inch wheels and performance tires.<sup>5</sup>

<sup>1</sup> Top speed limited electronically.

<sup>2</sup> BMW AG test results. Actual acceleration results may vary, depending on specification of vehicle; road and environmental conditions; testing procedures and driving style. These results should be used for comparison only and verification should not be attempted on public roads. BMW urges you to obey all posted speed laws and always wear safety belts.

<sup>3</sup> EPA-estimated figures are for comparison purposes only. Your actual mileage will vary, depending on speed, driving habits, trip length and driving conditions; actual mileage may be lower.

<sup>4</sup> Run-flat tires do not come equipped with a spare tire and wheel. However, a spare tire and wheel can be ordered as an option in BMW X6 xDrive35i and X6 xDrive50i.

<sup>5</sup> Performance tires are not recommended for driving in snow and ice.

Driving over rough or damaged road surfaces, as well as debris, curbs and other obstacles, can cause serious damage to wheels, tires and suspension parts. This is more likely to occur with low-profile tires, which provide less cushioning between the wheel and the road. Be careful to avoid road hazards and reduce your speed, especially if your vehicle is equipped with low-profile tires.



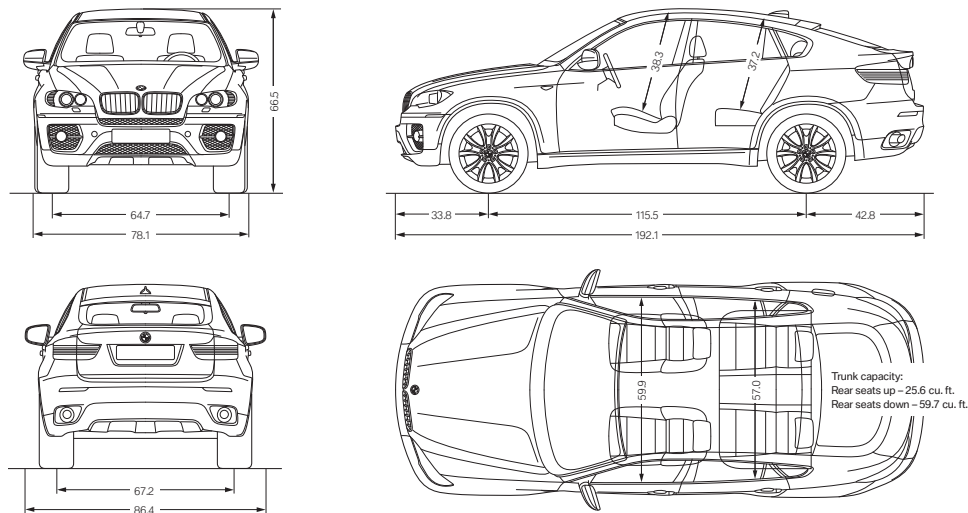

All dimensions of the technical drawings in inches. Height indicated with roof antenna and unloaded.

**BMW and the environment.**

BMW is a strong proponent of the environment and social responsibility. We launched BMW EfficientDynamics back in 2000 – the philosophy of providing greater power with increased efficiency and fewer emissions. This has resulted in significant benefits today – for our customers, the climate and the environment.

That year, ecological sustainability was also declared one of BMW's core strategic principles; it is now firmly anchored in our entire production chain. It starts with the development of fuel-saving and alternative vehicle concepts, continues with environmentally friendly production processes, and ends with innovative recycling methods. This effort has been recognized worldwide; in 1999, BMW AG – the parent company of BMW of North America and BMW Manufacturing Co. in Spartanburg, SC – was the first automotive company to be represented on the Dow Jones Sustainability Group Index. It has remained on the Index ever since; moreover, since 2005, BMW has been voted the world's most sustainable automobile manufacturer. At BMW, we strive for and achieve high performance in all we do.

U.S. Distributor: BMW of North America, LLC, Woodcliff Lake, NJ 07677. All illustrations and specifications contained in this brochure are based on the latest product information available at the time of printing. BMW reserves the right to make changes at any time, without notice, in colors, materials, equipment, specifications and models. BMW may, subject to legal requirements, determine the Model Year designation of its vehicles. The Model Year designation on any particular model may be longer or shorter than 12 months. Some vehicles pictured may contain non-U.S. equipment. Some models may be shown with optional equipment. While BMW NA makes all reasonable efforts to provide accurate information in this brochure, there is no guarantee or warranty of accuracy. Furthermore, we do not assume any liability for the accuracy or completeness of information presented. This brochure shall not be used or relied upon as a substitute for information that is available from your BMW center. Further information can be obtained from your authorized BMW center or [bmwusa.com](http://bmwusa.com).

©2011 BMW of North America, LLC. Not to be reproduced wholly or in part without written permission of BMW NA. The BMW name, logo, model names, Sports Activity Coupe and SAV are registered trademarks. The Bluetooth word mark and logos are owned by the Bluetooth SIG, Inc. and any use of such marks by BMW is under license. iPod and iPhone are registered trademarks of Apple Inc. Other trademarks and trade names are the property of their respective owners.

BMW recommends **EDGE**

**EQUIPPED WITH THE BEST IDEAS.  
ORIGINAL BMW ACCESSORIES.**



Add the convenience of a rear-deck bicycle holder, and the bold gleam of 21-inch Star Spoke (Style 128) chrome wheels.

Driving a BMW is always a special experience – and it can be enhanced even further with Original BMW Accessories. Benefit from innovative solutions that combine unique ideas, stunning design and smart functionality. Discover a wide range of Original BMW Accessories that customize, enhance and protect your BMW X6's exterior, interior, technology and transporters. From load carriers to cargo mats, sheepskin seat covers and more, every Original BMW Accessory adheres to BMW's

highest quality standards. Each is designed to fit the BMW X6 perfectly and last just as long. For additional information on BMW Accessories, please see your authorized BMW center or visit online at [shopbmwusa.com](http://shopbmwusa.com).

NOTE: Some details shown in photographs may not be available in the United States.



**BMW Roof Box 460** comes in Silver or Black, or paint it to match your BMW X6. The innovative design lets you load from either side and includes anti-theft triple central locking for security.



**Snap-in-Adapter for iPhone®** lets you control music and make hands-free calls through the steering wheel or iDrive.



**Non-slip dual-sided cargo mat** tailored to fit the BMW X6 helps keep the cargo area carpet clean.

We believe that a premium ownership experience should feature performance and luxury, as well as safety and convenience. We believe you should be able to drive a BMW to its potential, while enjoying peace of mind and reduced cost of ownership. That's the idea behind **BMW Ultimate Service**®: a suite of comprehensive programs and services that are included in every new BMW vehicle.

## GOING BEYOND ENGINEERING: THE HIGH-PERFORMANCE BMW OWNERSHIP EXPERIENCE.

**BMW Maintenance Program** is one of the most comprehensive maintenance programs in its class. We cover all factory-recommended maintenance during the New Vehicle/SAV Limited Warranty coverage period. This includes scheduled oil services and inspections. Also covered is the replacement of items that are subject to normal wear and tear, such as brake pads, wiper blade inserts and engine drive belts.<sup>2</sup> And, thanks to BMW's advanced engineering, most owners enjoy a well-balanced maintenance schedule, with flexible routine service intervals that can save you time. When your vehicle requires attention, your authorized BMW center ensures that it receives only genuine BMW parts – your assurance of exacting quality standards.

For more details on BMW Ultimate Service and the BMW Maintenance Program, visit your authorized BMW center or log on to [bmwusa.com/ultimateservice](http://bmwusa.com/ultimateservice).

**BMW Assist Safety Plan**<sup>3</sup> is a four-year program that lets you enjoy peace of mind knowing that a friendly response specialist is there to help you, 24/7, at just the push of a button. The Safety Plan includes Automatic Collision Notification, Emergency Request, Enhanced Roadside Assistance, Door Unlock, Stolen Vehicle Recovery and Customer Relations. Included in the BMW Assist Safety Plan, MyInfo allows you to send business locations and street addresses with their associated phone numbers from the Google Maps™ website directly to your BMW. The destination can be sent to your Navigation system for turn-by-turn directions. With the BMW Navigation system and your mobile phone linked to your BMW via Bluetooth® technology, BMW's Mobile Office feature<sup>4</sup> transfers text messages and emails to your Drive Display screen and reads them aloud to you. A Calendar and To-do List can also appear on your Display screen while en route. Running late? Click on the phone number in the Calendar to call your appointment. For a list of tested mobile phones, visit [bmwusa.com/bluetooth](http://bmwusa.com/bluetooth).

BMW Ultimate Service starts with the **New Vehicle/SAV Limited Warranty**,<sup>1</sup> providing you with coverage for the first four years or 50,000 miles, whichever comes first. Additionally, you have 12-year, unlimited-mileage warranty protection against corrosion and rust perforation.<sup>1</sup> The **BMW Maintenance Program**<sup>2</sup> and **BMW Assist**,<sup>TM3</sup> as well as **BMW Roadside Assistance** come standard.

For the ultimate in coverage, add the optional **BMW Assist Convenience Plan**.<sup>5</sup> You'll enjoy unlimited access to personalized Directions, Traffic and Weather reports, as well as our Concierge feature, which can send a destination address and phone number, such as a restaurant or hotel, right to your BMW. You can make up to four operator-assisted calls per year with Critical Calling if your cell phone is not available, or if its battery is discharged. BMW Online allows access to up-to-date fuel prices and the latest weather forecasts, as well as Bloomberg's stock indices and the powerful reach of the Google Maps database – delivered to the iDrive Display right inside your vehicle.

BMW's unique **TeleService**, included in the BMW Assist Safety Plan, continually monitors specific parts that are subject to wear and tear – including the engine oil, micro-filter, spark plugs, brake linings and various fluids – as well as services that require attention at regular intervals, such as vehicle service inspections. This data is

automatically transmitted to your authorized BMW center, which will then call you to schedule a service appointment. You don't have to keep track of when your vehicle requires routine maintenance. An added benefit: any needed maintenance service parts will already be on hand, so your BMW is serviced and returned to you as quickly as possible. And because they use only Original BMW Parts, you can rely on expert fit and long-lasting BMW quality. For more details on TeleService, visit [bmwassist.com](http://bmwassist.com).

**BMW Roadside Assistance** is provided free of charge for the first four years – with no mileage limit. Call **1-800-332-4BMW (4269)** for friendly on-the-road help, 24/7, anywhere in the United States, Canada and Puerto Rico. This includes everything from flat-tire changes, emergency gasoline and lock-out service, to towing, alternative transportation and even trip-interruption benefits. This service also provides valuable trip-routing advice.



**BMW Virtual Center.** If you get the sudden urge to shop for a BMW but your authorized BMW center is closed, there's good news – the BMW Virtual Center is open 24 hours a day! Log on to [bmwusa.com/byo](http://bmwusa.com/byo), and choose the model that interests you. Configure the BMW of your dreams, and see what the monthly payments would be. You can even send the specifications to your authorized BMW center, apply for financing, or request a test drive – all online!

**BMW Financial Services.** Arranging to buy or lease a BMW is easier than you may think. Your authorized BMW center offers leasing and financing to suit your personal needs through BMW Financial Services.<sup>6</sup> Start the process at our website, where you can build your "dream vehicle," get an estimate on a monthly lease or financing payment, submit a credit application to BMW Financial Services – and get approval – all online!<sup>6</sup> To find out how BMW Financial Services can help put you behind the wheel of your favorite BMW model, log on to [bmwusa.com/fs](http://bmwusa.com/fs) or call, toll-free, **1-800-578-5000**.

**BMW Magazine.** A fascinating view of the latest events and products in the world of BMW, including travel reviews, personality profiles, and the latest BMW technologies. Sent to new owners and lessees several times a year, you can also read articles from **BMW Magazine** on the BMW website at [bmwusa.com](http://bmwusa.com) under the "Media Gallery & Library" heading, found in the "Experience" section.

**BMW Welt:** The **BMW Welt** ("BMW World") delivery and brand-experience center in Munich is bold proof of BMW's passion for design. When you take advantage of the BMW European Delivery Program,<sup>7</sup> this is where you will meet your new BMW – in a personalized process that is highly dramatic and totally unforgettable. (You might also realize substantial savings that just may pay for your trip.) While you're there, marvel at the historic BMWs in the Museum; learn about our engineers' newest innovations in the Technology and Design Atelier; and take a tour of the plant to experience firsthand the state-of-the-art methods used to create a BMW. Then comes the unique experience of driving your new BMW on the roads it was designed for. To learn more, visit [bmwusa.com/europeandelivery](http://bmwusa.com/europeandelivery).

<sup>1</sup> See your authorized BMW center for details on these limited warranties.

<sup>2</sup> The BMW Maintenance Program covers factory-recommended maintenance services as determined by the Service Interval Indicator for all new eligible MY 2004 and later BMW vehicles. Specific additional items that need replacement due to normal wear and tear are also covered. The maintenance coverage period is for the first 4 years or 50,000 miles, whichever comes first. Exclusions from coverage include: gasoline, gasoline additives, windshield washer fluid and additives, battery, tires, wheels, wheel alignment and tire balancing. All work must be performed by an authorized BMW center. See the Service and Warranty Information booklet for specific terms, conditions and limitations. Further information can also be obtained from your authorized BMW center.

<sup>3</sup> The BMW Assist with 4 years of Safety Plan services is standard. In order to receive BMW Assist services, a subscriber agreement must be completed and transferred to the BMW Assist Response Center. GPS and underlying wireless services must be available and functioning; vehicle ignition must be turned on (except for Door Unlock and Stolen Vehicle Recovery), battery charged and connected and vehicle's electrical system operational; services may be limited to certain geographic areas. Call toll-free **1-888-333-6118**, go to [bmwassist.com](http://bmwassist.com), or visit your authorized BMW center for additional program details. Services are subject to the terms and conditions of your subscriber agreement.

<sup>4</sup> Not all mobile phones are compatible with Mobile Office, and some compatible phones support a limited number of Mobile Office functions. For the complete list of compatible mobile phones and the details regarding which Mobile Office functions are supported by each phone, please visit [bmwusa.com/bluetooth](http://bmwusa.com/bluetooth).

<sup>5</sup> Requires BMW Assist Safety Plan subscription. Services are subject to the terms and conditions of your subscriber agreement. Please go to [bmwassist.com](http://bmwassist.com) for additional details on the optional Convenience Plan.

<sup>6</sup> Subject to credit approval and other terms and conditions.

<sup>7</sup> Not all models available for BMW European Delivery Program. Please go to [bmwusa.com](http://bmwusa.com) or visit your authorized BMW center for details.

### BMW Performance Driving School.

Whether you're a seasoned driver or just got your learner's permit, our One- and Two-Day Schools can help take your skills to the next level. Behind the wheel of our new BMWs, and under the expert guidance of professional driving instructors, you'll hone your abilities on a versatile driving course: 1.7 miles of asphalt that can be configured in a multitude of ways. It's all about control and pushing a BMW to its limits – and yours.

### BMW Performance Center Delivery.

It's an unforgettable way to take delivery, compliments of BMW. After dinner and an overnight stay, you and a companion will get an in-depth introduction to your new BMW. Then explore the dynamic capabilities of a similar model, with driving tips from a BMW Performance Driving School professional instructor. **To learn more about the BMW Performance Center, call 1-888-345-4269 or visit [bmwusa.com/performancecenter](http://bmwusa.com/performancecenter).**

### The BMW Performance Center in Spartanburg, SC.

Just beyond the foothills of the Carolinas' Blue Ridge Mountains lies the \$12 million BMW Performance Center. This sprawling, modern complex houses the world-famous BMW Performance Driving School, as well as the Zentrum Museum, BMW Boutique, BMW Delivery Center, and a Corporate Conference Center. Nearby is BMW's only manufacturing facility in the U.S., where models, such as the SAV<sup>®</sup> are built for export worldwide. It's a unique place where BMW enthusiasts can spend days – or, in the surrounding area, an entire vacation.





More about BMW



bmwusa.com  
1-800-334-4BMW

The Ultimate  
Driving Machine®

