

BMW
Z4 Roadster

sDrive28i
sDrive35i
sDrive35is



The Ultimate
Driving Machine®



THE BMW Z4 ROADSTER.

OUTRUN THE ORDINARY.

BMW EfficientDynamics
Less emissions. More driving pleasure.

EXHILARATION IS IN OUR WHEELHOUSE.

When it comes to explaining the unparalleled thrills of the BMW Z4 Roadster, superlatives take a back seat. There is no comparison to the feeling of piloting a low-slung, track-honed BMW with the top down, as it delivers mile after mile of everything drivers most desire. With a choice of powerful yet efficient engine options, exquisite and luxurious appointments, and a sleek and attractive design, the Z4 simply leaves any competition far behind. Get in and discover our most compelling formula for excitement on the road.





The BMW Z4 Roadster

DEVELOPED AND DRIVEN TO INSPIRE.

- 06 Design**
Engineering marvel, emotional wonder.
- 12 Driving dynamics**
Born to compete, destined for glory.
- 22 Interior environment**
Catering to your every whim.
- 24 Personalizable retractable hardtop**
Freedom – a top priority.
- 26 Performance technologies**
Driving technology that springs to life.
- 28 Hyper Orange Package**
Bring out the beauty in this high-performance beast.
- 30 Motorsport heritage**
BMW Z4 GTE to race in ALMS.

Technology

DEFINING EMOTION IN MOTION.

- 32 BMW ConnectedDrive**
Features that add convenience and peace of mind while you're on the road.
- 36 BMW EfficientDynamics**
Technology that increases excitement and reduces fuel consumption and emissions.
- 38 BMW TwinPower Turbo engines**
Achieving maximum performance from minimum fuel consumption.
- 40 Chassis and safety features**
Innovative systems that enhance driving enjoyment, as well as active and passive safety features.

Equipment

AS INDIVIDUAL AS YOUR DREAMS.

- 44 BMW Z4 sDrive35is**
- 46 Hyper Orange Package**
- 48 M Sport Package**
- 50 Canyon Brown Package**
- 52 Exterior colors, upholstery materials and colors, and interior trims**
- 55 Recommended color combinations**
- 56 Equipment features and options**
- 61 BMW Individual hardtop in contrasting color**
- 62 Original BMW Accessories**
- 63 Build Your Own**

Overview

SPECIFICATIONS AND SERVICES.

- 64 Technical data**
- 66 BMW Services**
Exclusive offers for BMW customers.

For exclusive BMW photos, behind-the-scenes videos, and the latest BMW news:

Like us on Facebook:
[facebook.com/bmwusa](https://www.facebook.com/bmwusa)

Follow us on Twitter:
twitter.com/bmwusa

Find us on [youtube.com/bmwusa](https://www.youtube.com/bmwusa)

Follow us on [instagram.com/bmwusa](https://www.instagram.com/bmwusa)

Editorial

IT MAKES ITS POINT WITH EVERY DRIVE.

Why a roadster? Why seek the pure, unadulterated thrill in every mile? Why the sleek two-seat styling, slung lean and low to the road? Once you get behind the wheel of the BMW Z4 Roadster, all answers become apparent and all doubts are erased. There's the time-honored formula: sweeping long hood, low seating position and powerful engine, which drives the senses to their limits. There are the muscular styling and lithe frame, which deliver matchless road responsiveness and handling. And there's the cutting-edge technology that BMW puts into every vehicle, making an already impressive driving performance a truly breathtaking experience. Once you've chosen the way of the BMW Z4 Roadster, all your questions disappear.

[bmwusa.com/Z4](https://www.bmwusa.com/Z4)



ENGINEERING MARVEL, EMOTIONAL WONDER.

Everything that defines the classic Z4 feel and ferocity on the road are still firmly in place; what's new is many of the more meticulous details. Redesigned headlights stare down the pavement, joining forces with the broad kidney grille to reveal an intimidating, three-dimensional front facade. The newly introduced tapered surrounds for the side indicator lights contribute to a more dynamic, sweeping side near the gills. It's all a part of the electrifying experience of the Z4 – a dedicated pleasure machine if there ever was one.

FIND YOUR CENTER ON ANY ROAD.

If you're serious about driving, the BMW Z4 Roadster gives you more of what you want: freedom. Starting with the requisite near-perfect 50/50 weight distribution all BMWs share, the Z4 places its seats near the rear axle, so every curve puts a smile on the faces of both driver and passenger. From this ground-level platform, BMW offers three ways to determine your driving destiny. The Z4 sDrive28i delivers 240 hp and 260 lb-ft of torque, while the sDrive35i ups the output to 300 hp and 300 lb-ft of torque. Or go all out with the sDrive35is and command a whopping 335 hp and 332 lb-ft of torque. But whichever you choose, pure driving enjoyment is centered on you.







CHAMPION DNA TAKES A NEW SHAPE.

The BMW Z4 Roadster looks great from every angle – but none more so than doing what it was meant to do: tackling turns, powering through straightaways, and leaving drivers breathless. With its uniquely sporty design and motorsport-inspired DNA, the Z4 Roadster is the embodiment of the spirit of competition. In fact, the Z4 is taking that role more literally than ever as BMW of North America campaigns the Z4 GTE in the American Le Mans Series (ALMS) with BMW Team RLL. Already renowned among drivers worldwide, BMW hopes to drive the Z4 straight to the winner's circle. Now when you get behind the wheel of the Z4 Roadster, you can put race-bred levels of power, control and exhilaration in your hands.



THREE WAYS TO CONQUER FREEWAYS.

The heart of the Z4's personality is its high-performance engine: inside a lean and sporty design, the powerplant brings drivers far past the line of expectations. Enabling the dreams of those behind the wheel is a choice of three TwinPower Turbo engine options. With 240 hp and 260 lb-ft of torque on tap, the Z4 sDrive28i exemplifies efficient muscle. BMW's award-winning 2.0-liter four-cylinder engine gives up nothing in terms of impressive top end and pickup, to the tune of 5.5 seconds from 0-60.¹ The sDrive35i harnesses the universally praised 3.0-liter inline six-cylinder engine, cranking out 300 hp and 300 lb-ft of torque, with a 0-60 time of 5 seconds flat.² And not to be outdone by its dynamic siblings, the sDrive35is offers a sport-tuned version of BMW's 3.0-liter inline six-cylinder engine, producing an amazing 335 hp and 332 lb-ft of torque, for a 0-60 time of just 4.8 seconds.

¹ With 6-speed manual transmission.

² With 7-speed Double Clutch Transmission.

BMW AG test results. See page 64 for technical data.

BMW urges you to obey all posted speed laws and always wear safety belts.



GEARED UP FOR ANY ADVENTURE.

When it comes to transferring power from the engine to the wheels, your transmission is the critical link. With the BMW Z4 Roadster, a trio of transmission choices make your driving experience a smooth one. Best of all, each is designed for maximum efficiency as well as sporty performance. The sDrive28i offers either a satisfying 6-speed manual or a velvety-smooth 8-speed automatic; the sDrive35i lets you take charge of either the 6-speed manual or BMW's race-inspired 7-speed Double Clutch Transmission (DCT). And with the sDrive35is, it's the 7-speed DCT all the way. Shift over to the BMW Z4 Roadster – and leave ordinary driving in the dust.

Get the latest information on BMW standard and optional features, packages and technical specifications. Visit bmwusa.com, select the BMW model of your choice, and click on "Features & Specs."



M: THE ONLY LETTER MORE POWERFUL THAN Z.

For all the thrilling moves the Z4 Roadster makes, BMW is proud to enhance its race-winning heritage with the M Sport Package. The components of this dynamic package – included in the Z4 sDrive35is, and available in the Z4 sDrive28i and Z4 sDrive35i – deliver even sportier handling, thanks to the Adaptive M Suspension, the M aerodynamics package with large air intakes in the front wing, and large 18-inch M light alloy wheels. Interior upgrades are numerous, as well: take command in specially bolstered sport seats while gripping the leather-wrapped M steering wheel. Find excitement in even the smallest details, such as the M driver's footrest, gear lever knob and door sill finishers; Anthracite headliner; Aluminum Carbon Shadow trim strip; and gray dials on the instrument cluster. The M Sport Package: the fastest way to turbocharge your Z4's sporty personality.

Get the latest information on BMW standard and optional features, packages and technical specifications. Visit bmwusa.com, select the BMW model of your choice, and click on "Features & Specs."





CATERING TO YOUR EVERY WHIM.

The BMW Z4 Roadster is all about one thing: you. Even while nailing challenging curves, the Z4's plush interior, filled with the finest comfort and convenience features, ensures every trip is exactly your speed. This harmonious environment, clad in the most elegant upholstery and trim options, is enhanced by the Z4 Roadster sound system, including CD player, auxiliary input and 11 speakers. Select the Premium Sound System, and both the output and number of speakers increase. The onboard Navigation system provides high-resolution maps on the 8.8-inch monitor. And an expanded roster of BMW ConnectedDrive features makes it easier than ever to maintain a mobile window on your life, giving you access to BMW Apps, online content, infotainment, and much more.

Get the latest information on BMW standard and optional features, packages and technical specifications. Visit bmwusa.com, select the BMW model of your choice, and click on "Features & Specs."



FREEDOM – A TOP PRIORITY.

BMW now lets you personalize the Z4 Roadster's retractable hardtop with a choice of two colors: brilliant Titanium Silver Metallic and stunning Jet Black. With the retractable roof up, the bold lines and available contrast of roof and body colors enhance the Z4's sporty low-slung silhouette. Inside, BMW's automatic climate control keeps the cabin continuously comfortable, while the heated rear-view window

remains frost-free. However, even the visual and sensory pleasures of the Z4 Roadster's sporty design with the top up cannot match the pure excitement of open-air driving. So at the touch of a button, the Roadster brings you closer to the elements, as the hardtop goes down in a mere 19 seconds – even while traveling at speeds of up to 25 miles per hour.

Get the latest information on BMW standard and optional features, packages and technical specifications. Visit bmwusa.com, select the BMW model of your choice, and click on "Features & Specs."

DRIVING TECHNOLOGY THAT SPRINGS TO LIFE.

Going beyond theories, hypotheses and intangibles, the track-tested technologies on board the BMW Z4 Roadster virtually defy the laws of physics, all for the benefit of driving pleasure. For example, the extensive, innovative use of stiff yet lightweight components in the suspension ensures a responsive road feel. There are also advanced systems within the Z4 Roadster that contribute to an even more satisfying driving experience. Within easy reach on the center console is the Driving Dynamics Control switch that calls up a choice of COMFORT, SPORT and SPORT+ driving modes to suit your mood by changing performance parameters – from shift characteristics and engine response, to the Dynamic Stability Control system and Servotronic functions. It's an immediate and gratifying way to turn sophisticated technology into simple thrills.





BRING OUT THE BEAUTY IN THIS HIGH-PERFORMANCE BEAST.

When it comes to luxury performance, the BMW Z4 Roadster certainly looks the part. The exterior paint selections, trim packages and additional elements are designed to enhance its elegant curves and bold contours. Case in point: the electrifying style of the Hyper Orange Package. Among the exterior paint choices is the eye-catching Valencia Orange Metallic; inside, the leather-upholstered seats are finished in Black/Orange contrast stitching, complete with an accent stripe

running down the backrests and seat cushions. The rich Orange Alcantara door trim panel and Metal Weave trim strip at the door openers and gear shift or selector knob also serve as reminders that the Z4 possesses a one-of-a-kind sporty personality.

Get the latest information on BMW standard and optional features, packages and technical specifications. Visit bmwusa.com, select the BMW model of your choice, and click on "Features & Specs."

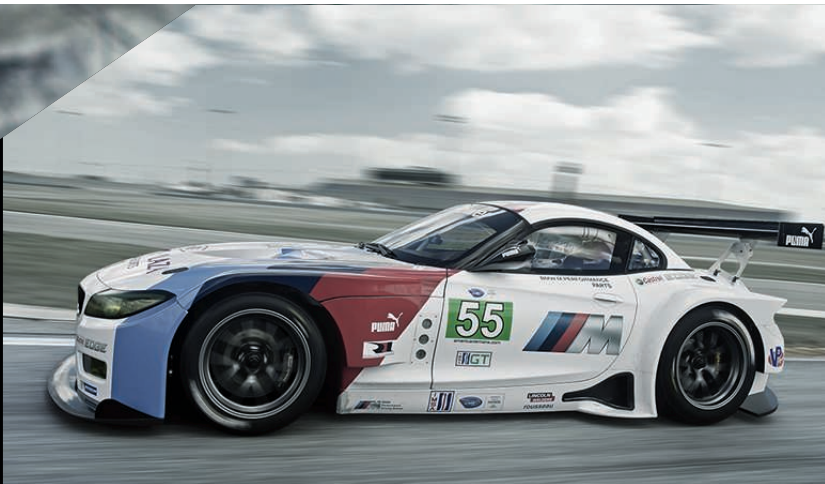

**BORN TO COMPETE,
DESTINED FOR GLORY.**



The legacy of BMW racecars takes another leap forward as a new high-performance challenger enters the American Le Mans Series (ALMS): the Z4 GTE. The successor to the champion M3 racecar that scored back-to-back class titles and seven victories since its 2009 debut, the Z4 GTE was created from the ground up. Based on the formidable Z4 GT3 racecar, the Z4 GTE is modified to adhere to Automobile Club de l'Ouest (ACO) regulations. Its lowered suspension and improved aerodynamics perfectly complement BMW Team RLL's track-honed, innovative engineering.

Throughout the 2013 ALMS season, two Z4 GTEs will be tackling some of the most storied tracks in the country. A mix of veteran and young drivers will pursue glory behind the wheel. Bill Auberlen and Maxime Martin will pilot car number 55; 2011 ALMS GT Class-winning drivers Dirk Müller and Joey Hand will be in car number 56, with John Edwards substituting for Hand when he races in Europe in the DTM. Working with the seasoned crew at Rahal Letterman Lanigan Racing, the BMW Team RLL drivers are anticipating many more returns to the podium this year. As driver Joey Hand summed it up, "No matter what, we always go in to win." Follow the exciting season as it unfolds at bmwusa.com/motorsport.





BMW ConnectedDrive In touch with your world.

Every day, our world is becoming increasingly networked. Many BMW drivers, however, are better connected than the rest, obtaining information on the road, communicating by phone or email, and always updated on the latest events. BMW ConnectedDrive encompasses all these services, including traffic features that allow BMW vehicles and their occupants to network with the outside world.



Enhanced mobile networking. The BMW Vision ConnectedDrive is a visionary Roadster whose amazing design goes far deeper than its dynamic, flowing lines. Three levels in the interior each symbolize a facet of BMW ConnectedDrive – Convenience, Infotainment and Safety; accompanying functions and controls are highlighted with different colored lights that illuminate information. An extraordinary synthesis of exterior and interior style and substance, the BMW Vision ConnectedDrive points the way to a mobile networking future. More information on this concept vehicle and other research projects can be found in the Future Lab.

bmw.com/futurelab

BMW CONNECTED DRIVE: CONVENIENCE, INFOTAINMENT AND SAFETY TECHNOLOGIES MEET IN ONE SUITE.

With BMW ConnectedDrive you stay in touch, no matter where you go. Its advanced communications and entertainment features create a network between driver, vehicle and environment, at any time and wherever you are. The following pages present special highlights in the areas of convenience, infotainment and safety. For a comprehensive overview of the BMW ConnectedDrive range, see bmwusa.com/connecteddrive.

Convenience. These fascinating BMW ConnectedDrive innovations offer service-oriented functions, such as Real Time Traffic Information and Comfort Access. So you can always relax in your BMW.



Real Time Traffic Information is a valuable feature, included with the Navigation system, that makes you aware of traffic congestion in most large cities before you encounter it. This feature displays and describes current local traffic information on your Control Display; in case of delays greater than five minutes, it suggests alternate routes.



Park Distance Control (PDC). Ultrasonic sensors in the front and rear bumpers help you judge the distance to other cars and unseen objects when parking. The warning beeping becomes faster as your bumper approaches the object, turning into a constant tone when the distance is less than 12 inches.



Comfort Access, including exterior door handle illumination. Enjoy convenient keyless access to your vehicle. Simply carrying the remote key in a pocket or purse allows you to unlock the doors by touching the door handle. You can also turn the engine on or off by pressing the Start/Stop button without inserting the remote key. (Note: For the engine to start, your foot must be on the brake; with manual transmission, you must first depress the clutch.)

STAY TOTALLY IN TOUCH WHEREVER YOU GO – WITH BMW CONNECTED DRIVE.

Whether you're far from home or just in the next town, ConnectedDrive offers convenience and peace of mind. There are new features that extend BMW's leadership in wireless communications. Marvel at an extensive array of Mobile Office functions. Get a visual image of your callers. With BMW Assist, you enjoy all this – and more.



BMW Apps lets you access Social Networks, music Plugin and Video Playback through your iPhone,¹ and see them on the Display screen.¹ Tune in to **Web radio** and search for stations from around the globe by name, location or genre. You can also store your favorite stations, find similar stations, display station information, and change the quality of the audio. Your favorite entries are stored on your iPhone, so you can take them with you from one vehicle to another.

Please note: • A broadband data link is required. The costs for this (e.g., data roaming) are regulated by the customer agreement with the mobile phone service provider.
 • Not all features available while vehicle is in motion; see dealer for details.
 • Web radio audio quality depends on the bit rate of the station, and data reception depends on your cell service. Data transfer comes over the iPhone.

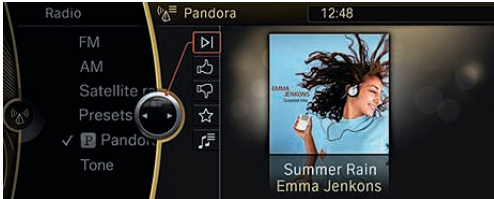

Part of BMW Apps, **Pandora Radio** is an innovative streaming audio service that delivers personalized music selections right to your BMW.¹ Create new stations and tailor your listening experience by rating songs with either a thumbs-up or thumbs-down. Even while listening, you can stay in touch: your BMW can still receive calls through Bluetooth[®] without missing a beat.

¹ Requires BMW Apps option and a compatible iPhone and iOS version.

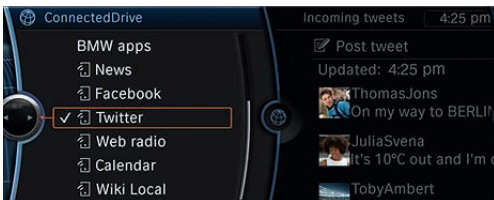

BMW Connected App, a suite of integrated web-connected features, can read aloud your Facebook[®] and Twitter[™] feeds, and lets you send prewritten tweets with a single click. **Wiki Local**, a geographically based feature, finds and reads aloud Wikipedia[®] articles relevant to the place you select – while **Wiki Tourguide** takes you through a list of articles about nearby points of interest, sorted by distance from your vehicle's current location. The **Last Mile Navigation** and **Vehicle Finder**, also included in the BMW Connected App suite, provides walking directions to your destination after you've parked – and directions back to your car later.

Please note: Local information may not be available in all areas.

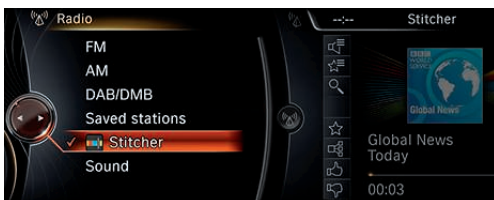

Add the popular **Stitcher SmartRadio[™]** app to your smartphone and create your own personal talk radio station experience. The mobile leader in on-demand news, entertainment, sports and talk radio, Stitcher SmartRadio not only lets you create and run your favorite programs, it introduces you to new content, based on your personal preferences.

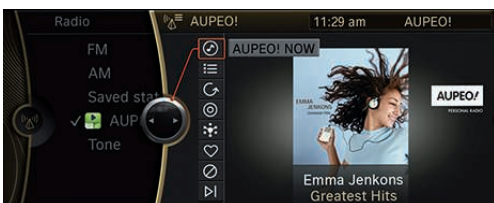

Enjoy discovering new favorite sounds in your BMW, thanks to the **AUPEO! Personal Radio** app – another part of BMW Apps. This customizable internet radio service uses a recommender system to match music to your individual taste. Enter a genre or artist, and an algorithm developed by the Fraunhofer Institute recommends tracks that match your taste, compiled from a database of almost one million tracks. You can also use the Mood Tuner function, which selects sounds according to mood; or choose from more than 150 channels pre-compiled into categories, such as 80s Best or Rock Classics.



Use the time you spend in your vehicle even more effectively with BMW's **Mobile Office** feature.² For example, text messages and emails can be transferred from your Bluetooth paired phone directly to the vehicle's Control Display and can be read back to you using Text-to-speech functionality and the vehicle's audio system.

² Not all mobile phones are compatible with Mobile Office, and some compatible phones support a limited number of Mobile Office functions. For the complete list of compatible mobile phones and the details regarding which Mobile Office functions are supported by each phone, please visit bmwusa.com/bluetooth.



MyInfo allows you to send business locations and street addresses to your BMW from Google Maps.[™] Destinations and phone numbers can be accessed and exported to your Navigation system for immediate route guidance.



BMW Online allows online access to up-to-date fuel prices and gas station locations; the latest weather forecasts, advisories and warnings; Dow Jones, S&P 500 and NASDAQ indices; and the powerful reach of the Google Maps database – all delivered on the Control Display inside your vehicle. Access news headlines and have them read aloud via Text-to-speech technology. "Send to Mail" pinpoints your current location and planned destination, and allows you to send the information to any smartphone or email account. Then it's just a quick hyperlink to Google Maps for your friends and family to see where you are and where you're going.



Enhanced functions for the iPod and USB adapter add to the ease and pleasure of using your iPod or iPhone. Want to know which CD that song comes from? The album cover is shown on your Display screen. Don't purchase additional cables – your iPod or iPhone's original USB cable connects to your BMW's USB port. Another rare feature: with BMW Assist and Bluetooth audio streaming, you can wirelessly play music through the BMW audio system from any Bluetooth compatible music player or mobile phone, from anywhere in your vehicle.



BMW Assist eCall gives you peace of mind knowing that a friendly response specialist is there to help you 24/7, at the touch of a button. BMW Assist eCall includes Automatic Collision Notification, Emergency Request (SOS button), TeleService, Enhanced Roadside Assistance, and Customer Relations.

Concierge adds personalized directions and services for restaurant and hotel recommendations, with the destination address and phone number sent to your BMW. Make up to four operator-assisted calls per year with Concierge and Critical Calling if your mobile phone is not available or its battery is discharged.



BMW EfficientDynamics

Less emissions. More driving pleasure.

BMW was one of the first manufacturers to pursue the goal of efficient driving technologies, as part of a multi-award-winning sustainability strategy. BMW EfficientDynamics represents an acclaimed standard package of innovative technologies that reduce fuel consumption and emissions, while simultaneously enhancing dynamic performance. Since 1995 BMW has been able to reduce the CO₂ emissions of its entire fleet by approximately 30 percent, and intends to achieve a further 25 percent reduction by 2020.



BMW EFFICIENT DYNAMICS – MAKING A LITTLE GO A LONG WAY.

Different paths to the same destination: unmistakable BMW driving pleasure. Under the umbrella of the BMW EfficientDynamics project, BMW is continuously developing innovative systems that will bring us closer to the goal of emissions-free mobility in the long term. This BMW program for more driving pleasure is based on several pillars:

Eco-friendly technology. The development of more efficient vehicles powered by conventional diesel and gasoline engines are continuing challenges. A comprehensive technology package enables the reduction of fuel consumption and emissions, while at the same time increasing power output and driving enjoyment. These advances are based on innovations such as BMW TwinPower Turbo technology, Brake Energy Regeneration, and many others.

BMW ActiveHybrid. With the BMW ActiveHybrid 3, BMW ActiveHybrid 5 and BMW ActiveHybrid 7, BMW has impressive hybrid production models in its range. All combine outstanding efficiency with superlative dynamic ability.

BMW ActiveE. Since 2011, there has been a new form of dynamism on the roads: the all-electric BMW ActiveE. It is manufactured in a small production run, as part of a pilot project. In this way, BMW is preparing the way for the emissions-free mobility of the future.

BMW i. The BMW i will launch two completely new vehicle concepts for sustainable mobility in an urban environment. Key features of the BMW i3 and BMW i8 concepts include the use of lightweight materials such as Carbon Fiber Reinforced Plastic (CFRP), electric drive systems, powerful battery technology and eco-friendly production methods. The BMW i3 will be on the road in late 2013 and the i8 in 2014; both are an important part of EfficientDynamics technologies.

bmwactiveatthefuture.com
bmw-i-usa.com

THE BMW Z4 ROADSTER'S EFFICIENT DYNAMICS INITIATIVES AT A GLANCE.

Auto Start-Stop function.

The BMW Z4 sDrive28i with six-speed manual gearbox comes with the Auto Start-Stop function. During brief stops, for example at a red light, this function automatically switches off the engine to save fuel. A "Start-Stop" symbol in the Info Display indicates that the function is active.

Brake Energy Regeneration.

To supply the battery with electrical energy, the generator (alternator) is usually driven using engine power, which requires fuel. With Brake Energy Regeneration, the alternator generates electricity only when you take your foot off the accelerator. Kinetic energy that was previously unharnessed is transformed into electrical energy, which is then fed into the battery. In this way, electricity is generated without consuming fuel.

Electric Power Steering.

Unlike conventional, hydraulic steering systems, electric power steering draws power only during actual steering movements. When the steering wheel position is constant, the electric motor is inactive.

BMW TwinPower Turbo technology.

This innovative twin-scroll turbocharging technology efficiently reclaims the energy contained in exhaust gases, using a twin-scroll charger with a double-flow exhaust system. It also combines advanced injection technologies and fully variable power control for superior efficiency to enhance dynamic performance.

High Precision Direct Injection.

In this latest-generation direct fuel injection system, the piezo injectors are positioned very close to the spark plugs. They inject fuel at high pressure, with extreme precision, for very efficient combustion.

Lightweight construction.

Our engineers use lightweight aluminum throughout our vehicles – for example, in the front section, or for the suspension, or in the construction of the TwinPower Turbo engines. Taken together, these weight savings lead to lower fuel consumption and better axle load distribution for more agility, especially in curves.

Not all BMW EfficientDynamics features are available on all models. Please see your authorized BMW center for details.

SATISFYING POWER SERVED UP IN THREE EXCITING FLAVORS.

Engines that power innovation. Year after year, numerous BMW engines have garnered accolades for their output, refinement and high-revving ability. Among this pantheon of powerplants is the TwinPower Turbocharged variants. It is only natural, then, that BMW has provided three exceptional TwinPower Turbo engines for the Z4 Roadster. Each one accelerates with a force that throws you back in your seat and doesn't stop until redline. And each is designed to deliver on BMW's EfficientDynamics philosophy: increased power with decreased fuel consumption and emissions. Whichever engine you select, you'll enjoy the thrill of BMW performance while helping to protect the environment every day.

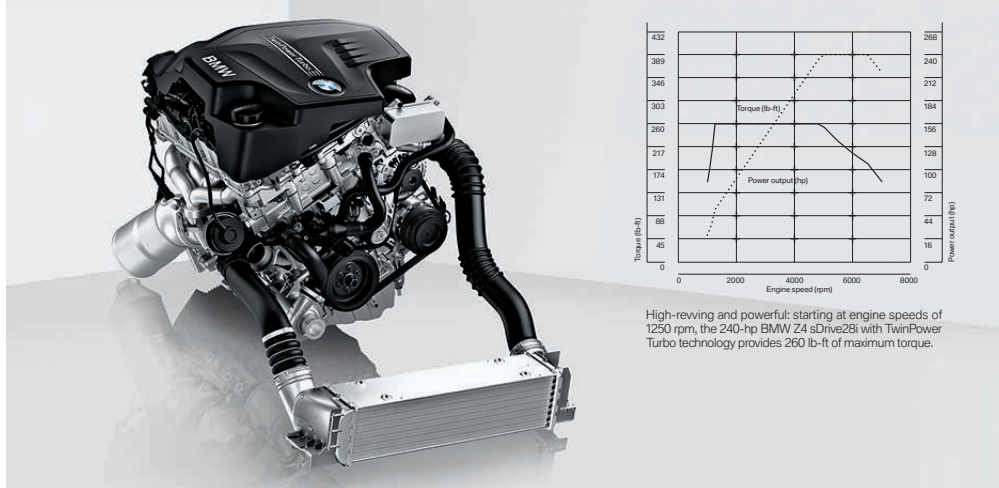

BMW Z4 sDrive28i.

Small is now the big idea in engines – namely, BMW's mighty inline four-cylinder TwinPower Turbo. Displacing just 2.0 liters, this 240-hp marvel generates 260 lb-ft of torque at just 1250 rpm, for potent thrust that kicks in right from the start and continues all the way up to 4800 rpm. Lightweight and smooth-running, this award-winning powerplant incorporates BMW's High Precision Direct Injection, Valvetronic and Double-VANOS technologies. Its dynamic performance is equaled only by its spectacular fuel efficiency.

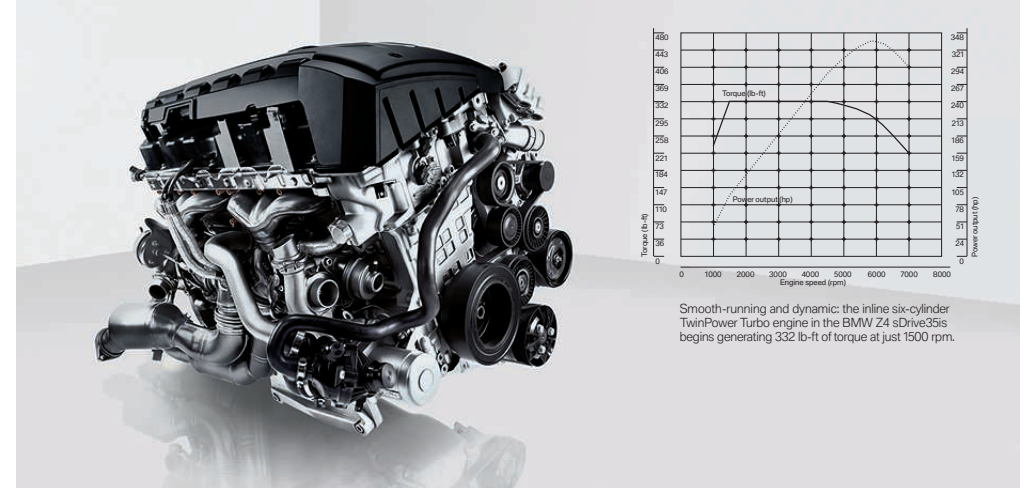

BMW Z4 sDrive35i.

BMW's universally lauded inline six-cylinder, twin-scroll TwinPower Turbo engine features High Precision Direct Injection and BMW's Valvetronic variable intake technology, which helps the engine "breathe" better. The result: turbo lag is virtually eliminated, while posting one of the most fuel-efficient ratings in its class. In just 5.0 seconds,¹ the Z4 sDrive35i is rushing past 60 mph, thanks to a maximum output of 300 hp at 5800 rpm. Adding to the excitement, 300 lb-ft of peak torque begins at just 1400 rpm and doesn't end until 5000 rpm.

BMW Z4 sDrive35is.

To create the potent inline six that propels the Z4 sDrive35is, BMW endowed its award-winning turbocharged engine with 35 more horsepower, 32 more lb-ft of torque, and an additional 37 lb-ft of temporary torque boost. An adrenaline-producing burst of acceleration propels it from 0–60 in 4.8 seconds!¹ And BMW EfficientDynamics ensures that every ounce of fuel is optimized during the performance.

¹ BMW AG test results with 7-speed Double Clutch Transmission. Please see page 64 for detailed technical data. BMW urges you to obey all posted speed laws and always wear safety belts.



Pure driving dynamics – it's a quality embodied by every single BMW without exception. And the technical basis for this thrilling driving experience lies in the suspension. It ensures optimal contact with the road surface and ideal road-holding in every situation – the result of near-perfect 50/50 weight distribution and an array of seamlessly combined innovative components. BMW engineers are continually re-inventing and refining those classic BMW driving dynamics to ensure that every BMW chassis puts the driver in direct contact with the vehicle and inspires a passion for sporty driving – while also providing the highest levels of safety and comfort.



THE FEELING OF DRIVING THE BMW Z4 ROADSTER IS SIMPLY INCREDIBLE. LIKE THE TECHNOLOGY BEHIND IT.

The BMW Z4 Roadster can be equipped with a whole host of innovative technologies to help you get the most out of each drive. Many of these systems are intelligently networked with each other, maximizing your active safety quotient – and your driving pleasure.

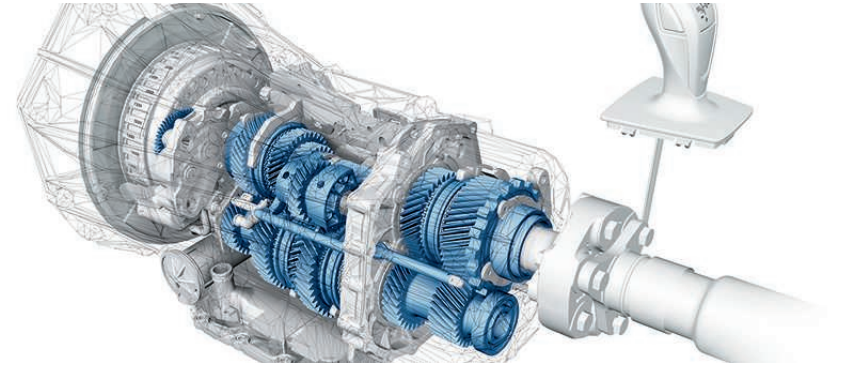

Adaptive M Suspension.

This technologically advanced suspension system incorporates electronically controlled dampers that adapt to the style of the driver and driving conditions. Settings can be designated via the Driving Dynamics Control button. The Adaptive M Suspension also lowers the vehicle approximately 0.4 inch without sacrificing ride comfort. Stiffer, more dynamic system settings can be selected by activating the SPORT or SPORT+ mode.

Rear-wheel drive.

BMW's renowned driving technology provides inspired vehicle agility and maneuverability. Rear-wheel drive enables an ideal distribution of weight over the entire chassis suspension, delivering power and traction more precisely onto the pavement.

8-speed Sport Automatic transmission.

The close spacing of gear ratios in the 8-speed Sport Automatic transmission allows maximum use of the optimum rev range. You enjoy dynamic performance and great ride comfort, combined with reduced fuel consumption and emissions.

7-speed Double Clutch Transmission.

In the 7-speed Double Clutch Transmission (DCT), the various gears are assigned to two clutches. As one gear is disengaged, the next one is already engaged, for even faster gear changes that take just a few milliseconds – hardly more than the blink of an eye. With this uninterrupted power flow from the engine, you enjoy breathtaking acceleration combined with superb ride comfort, thanks to the almost imperceptible gear changes. In addition, the fast and precise selection of the most efficient gear significantly reduces fuel consumption in automatic mode.

Driving Dynamics Control.

The ability to change driving characteristics in the BMW Z4 Roadster can be accomplished by pressing the Driving Dynamics Control button. To adjust engine-throttle response, transmission shift characteristics and power-steering assist, choose from three settings: COMFORT, SPORT and SPORT+ modes. In addition, the traction control feature can be disengaged when driving on sand, gravel, or deep-packed snow.

Get the latest information on BMW standard and optional features, packages and technical specifications. Visit bmwusa.com, select the BMW model of your choice, and click on "Features & Specs."

HIGH-TECH BODYGUARDS: ACTIVE AND PASSIVE SAFETY FEATURES.

The Z4 Roadster is designed with BMW's full range of state-of-the-art active and passive safety technologies. Active safety features, such as Xenon Adaptive Headlights, powerful engines and large brakes, help you see and respond to potentially dangerous situations. Should an accident prove unavoidable, passive safety features, such as the Z4 Roadster Rollover Protection System and airbags, are designed to help protect you and your passenger. After a severe impact, a host of features spring into action: the doors automatically unlock, headlights and taillights flash, the starter cable is disconnected from the battery, and the fuel supply is cut off. Should any airbags deploy, response specialists are automatically alerted via BMW Assist eCall™ and notified of your location.

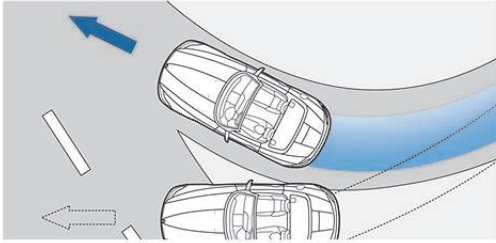

Dynamic Stability Control (DSC) is a braking control system that, when it senses an impending skid, helps to stabilize the vehicle in just milliseconds. If the system senses over- or understeer, it modulates engine power and can apply brakes individually to help keep the Z4 under control and going in the intended direction. For sportier driving or in deep snow, manually activate Dynamic Traction Control (DTC), to allow increased wheelspin.

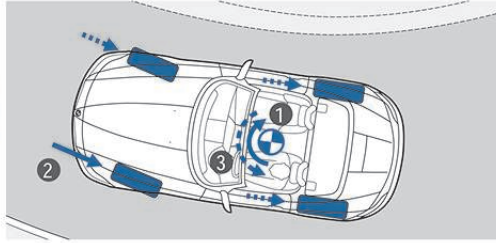

Cornering Brake Control (CBC) increases vehicle stability by proportioning the braking force while turning. When you brake in a turn, the pressure comes off the rear wheels, which (1) causes the vehicle to swerve inward (oversteer). Cornering Brake Control counteracts this action by asymmetrically adjusting brake pressure (2), creating stabilizing counter-torque (3) independently of the ABS system.

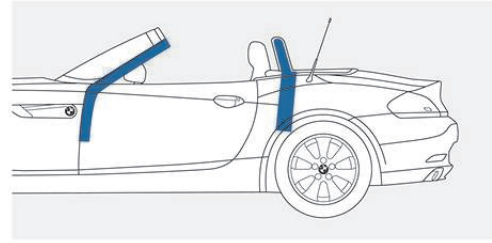

Z4 Roadster Rollover Protection System consists of two steel roll bars behind the headrests; they are connected with a highly stable chassis crossbeam. The system is completed by a bar of high-strength tubular steel integrated into the windshield frame for maximum safety.

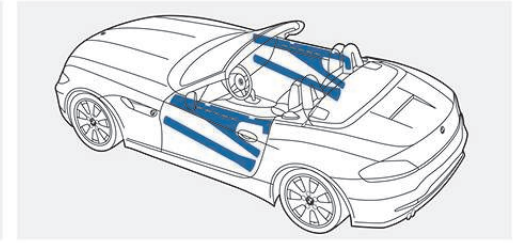

Door reinforcements are designed to provide maximum occupant protection in the event of a side impact. Added protection is provided by diagonal safety bars in the doors.

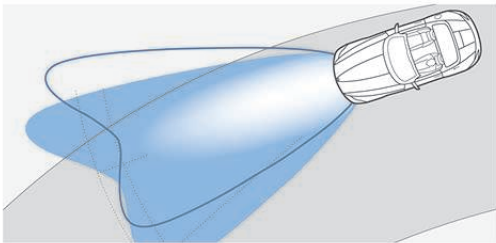

Xenon Adaptive Headlights automatically swivel to follow the curves of the road. The system uses data from on-board sensors and the steering wheel angle to determine the car's direction, then adjusts the headlights accordingly. The system offers outstanding nighttime visibility.

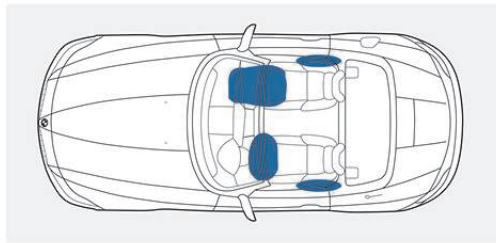

Front airbags help protect the head and upper body; **side airbags** significantly reduce the risk of injury to the head, ribcage and pelvic area in a side collision. If the passenger seat is unoccupied, these airbags are designed not to deploy. However, if a child seat is installed, these airbags must be manually deactivated. **Active knee protection** also helps protect knees in the event of severe impact.

Note: These pictures of airbags are for illustrative purposes only. Depending upon the type of accident, none, some or all airbags may deploy.

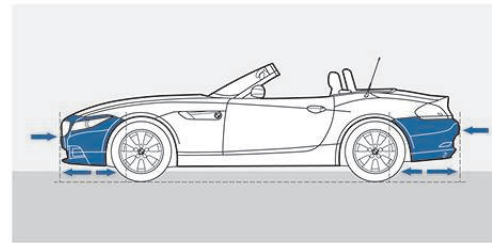

Impact-absorbing bumpers and compressible "crush tubes" front and rear help absorb the force of impact in collisions up to 9 mph, helping to minimize damage to the vehicle's body and simplifying repairs. Only at higher impact speeds do structural supports begin to deform, dissipating impact energy to help protect occupants.

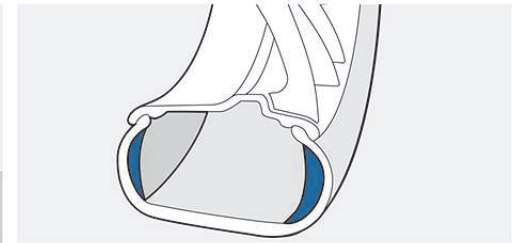

Run-flat tires maintain their shape and rim position even after suffering a complete loss of tire pressure, thanks to their reinforced sidewalls. They allow you to continue driving at a reduced speed until you reach a safe area to change a tire or wait for Roadside Assistance. The **Tire Pressure Monitor** alerts you when there is a drop in tire pressure; if the loss is severe, an acoustic warning is triggered.

Please see Owner's Manual for more information detailing allotted miles to travel and load weight rules for run-flat tires.

BMW Z4 sDRIVE35is – EXPONENTIALLY INTENSE.

The fire-breathing Z4 sDrive35is delivers pumped-up muscle, with horsepower rising to 335 and the 332 lb-ft of torque getting a temporary boost to 369 lb-ft. A lightning-quick 7-speed Double Clutch Transmission with paddle shifters puts all this power right at your fingertips, for a blistering 4.8-second 0–60 run.¹ Oil and water coolers were specially added to provide increased cooling capacity. The front underscores the added muscle with a signature kidney grille featuring aluminum matte slats and chrome bezel, and behind the front wheels, distinctive Z4 sDrive35is badging. A sport exhaust system with chromed tailpipes adds a finishing touch to the rear diffuser of the M sport rear bumper. Distinctive Star Spoke (Style 295) 18-inch wheels with staggered size performance tires come standard; Double Spoke (Style 326M) 19-inch wheels are also available. Inside, M door sills, Aluminum Carbon Shadow trim, and an instrument cluster with an exclusive colored dial denote special status. Refreshing design complemented by powerful performance technology make the Z4 sDrive35is an unmistakable yardstick whenever luxury-performance roadsters are compared.

¹ BMW AG test results. BMW urges you to obey all posted speed laws and always wear safety belts.



An all-black interior sets a powerful, sporting tone.



The stance: aggressively athletic.



Black Sapphire Metallic paint emphasizes the serious performance.

Wheel and tire specifications are subject to change. Get the latest information on BMW standard and optional features, packages and technical specifications. Visit bmwusa.com, select the BMW model of your choice, and click on "Features & Specs."

HYPER ORANGE PACKAGE: ENERGIZING SPIRIT.

The BMW Z4 Roadster was created for those who have a passion both for the road and for life. The Hyper Orange Package and M Sport/Hyper Orange Package were designed to bring even greater zest to the Z4 Roadster driving experience. Both combine the Metal Weave interior trim with sport seats upholstered in a dramatic black Alcantara/Leather combination, enriched by contrasting Orange details. Enhance the interior with your choice of Orange or Black Alcantara door trim insets and instrument panel bottom. High-Gloss Black trim in the center console surround and on door handle insets radiates a powerful energy. And, in addition to the full array of available Z4 Roadster paints, Valencia Orange Metallic – exclusive to this package – brilliantly combines with the contrasting Jet Black hardtop to emphasize the car's sporty character.



Electrifying: Alcantara/Leather combination with Orange accents.

The Orange Alcantara door trim insets extend a bright welcome.

Get the latest information on BMW standard and optional features, packages and technical specifications. Visit bmwusa.com, select the BMW model of your choice, and click on "Features & Specs."



The BMW Z4 Roadster glows in Valencia Orange Metallic.



Feel the excitement rev in this emphatically sporty interior.

BMW Z4 M SPORT PACKAGE: INSTANTLY UP YOUR GAME.

Give your Z4 sDrive28i or Z4 sDrive35i Roadster the competitive edge with the M Sport Package. An Aerodynamic kit, with specially shaped front and rear aprons, sharpens its ability to cut through wind. The 18-inch Star Spoke (Style 325M) light alloy wheels with mixed-size run-flat tires show your sporting intentions; in the Z4 sDrive35i, you can also specify 19-inch V Spoke (Style 296) light alloy wheels. A leather-wrapped multi-function M sport or M steering wheel ensures a firm grip – as does the Adaptive M Suspension, which delivers impressively agile road handling. Inside, specially bolstered sport seats hold you tight in curves. And when you're not admiring the drive, feast your eyes on exclusive interior touches, including Aluminum Carbon Shadow trim, Anthracite headliner, and M badged door-sill finishers, footrest and gear shift lever.



Exceptional grip: the leather-wrapped multi-function M steering wheel.



M badged door-sill finishers signal the Z4's special nature.



The aggressive-looking front grille bares its aluminum matte slats.



The Aerodynamic kit adds specially shaped front and rear aprons.

Wheel and tire specifications are subject to change. Get the latest information on BMW standard and optional features, packages and technical specifications. Visit bmwusa.com, select the BMW model of your choice, and click on "Features & Specs."

CANYON BROWN PACKAGE: SUMPTUOUS ELEGANCE.

Like dark chocolate in a beautiful wrapper, the Canyon Brown Package and the M Sport/Canyon Brown Package are a treat for the senses. In both packages, Rich Canyon Brown Extended Merino Leather and elegant Anthracite Wood trim fill the handcrafted cabin. This supple leather, enhanced by contrasting double stitching, is lavished not just on the highly supportive sport seats, but also on the dash, doors and center console. Treated with BMW's Sun-Reflective Technology, the seats and other surfaces stay cooler to the touch – even when parked in the sun with the top down. Select eye-catching Mineral White Metallic or another of the wide array of beautiful paint choices – all in the best taste.



The supportive sport seats appear especially welcoming when covered in premium Extended Merino Leather.

Automatic air conditioning controls are surrounded by rich Anthracite Wood trim.



Sophisticated appeal in Mineral White Metallic.



The cabin is stylishly set off by exquisite interior trim.

Exterior colors.

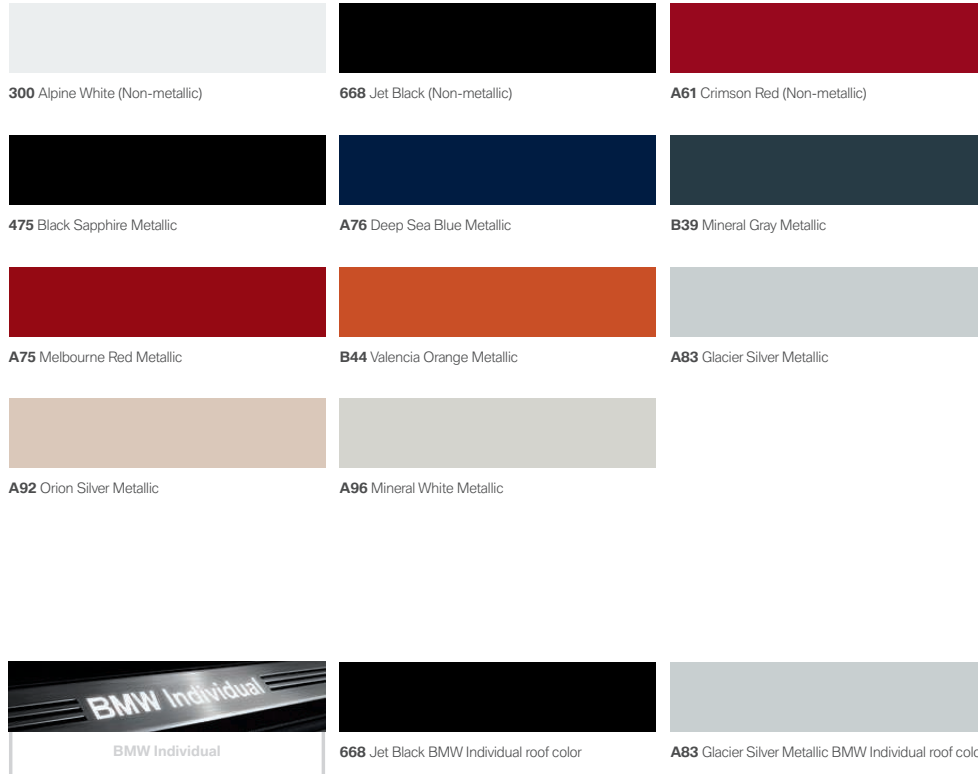

The following pages show the colors and materials available for the BMW Z4 Roadsters. Use these samples to compare paint, upholstery, trim colors and combinations. Please note that these samples are representations; they are not exact reproductions. To see the actual colors, visit your local BMW center. They will be happy to show you original samples and assist you with special requests.

Upholstery materials and colors.

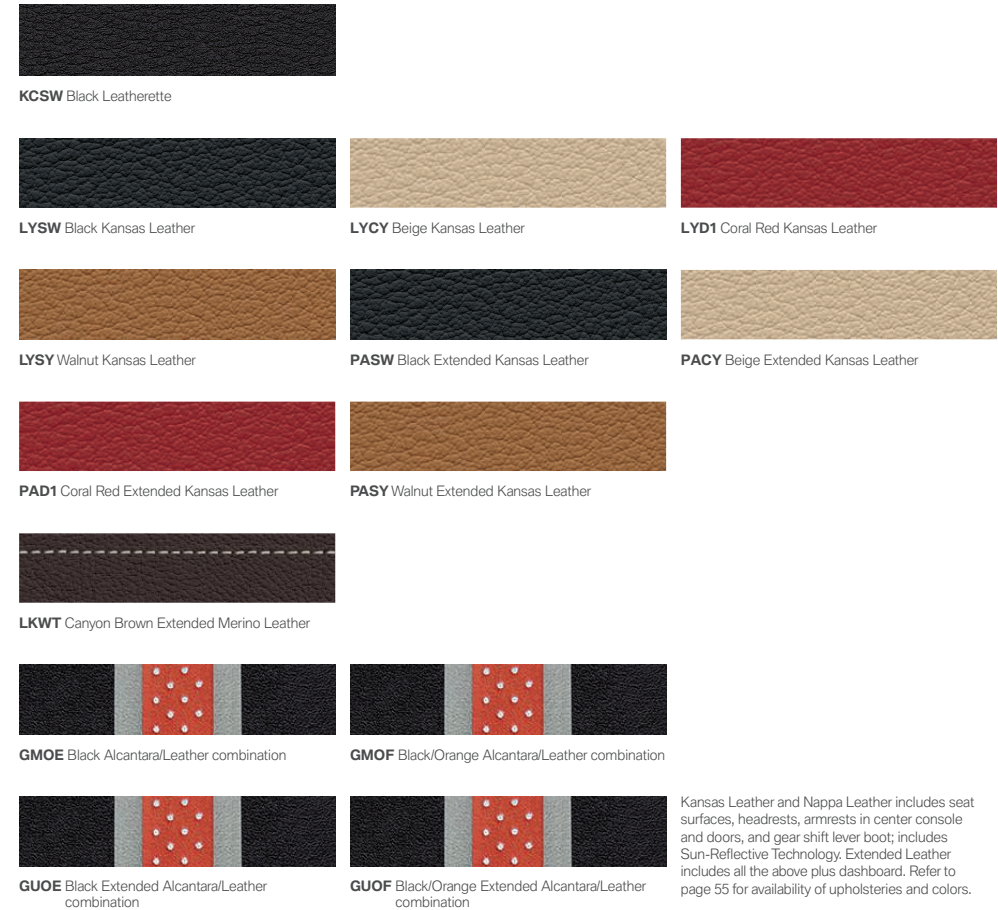

Kansas Leather and Nappa Leather includes seat surfaces, headrests, armrests in center console and doors, and gear shift lever boot; includes Sun-Reflective Technology. Extended Leather includes all the above plus dashboard. Refer to page 55 for availability of upholsteries and colors.

Interior trims.



4AD Brushed Aluminum



4MW Aluminum Carbon Shadow



4CE Anthracite Wood



4FE Metal Weave

Canyon Brown Package
M Sport/Canyon Brown Package



Interior trim: 4CE Anthracite Wood

Hyper Orange Package
M Sport/Hyper Orange Package



Interior trim: 4FE Metal Weave



Upholstery color: **GUOE** Black Extended Alcantara/Leather combination



Upholstery color: **LKWT** Canyon Brown Extended Merino Leather



Upholstery color: **GMOE** Black Alcantara/Leather combination



Upholstery color: **GUOF** Black/Orange Extended Alcantara/Leather combination

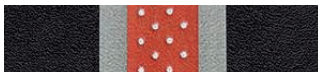

Upholstery color: **GMOF** Black/Orange Alcantara/Leather combination

Recommended color combinations.

	BMW upholstery colors														
	Leatherette		Kansas Leather				Extended Kansas Leather				Extended Merino Leather	Alcantara/Leather combination		Extended Alcantara/Leather combination	
	Black	Black	Beige	Coral Red	Walnut	Black	Beige	Coral Red	Walnut	Canyon Brown	Black/Orange	Black/Orange	Black/Orange	Black/Orange	
Interior colors															
Upholstery color	Black	Black	Beige	Coral Red	Walnut	Black	Beige	Coral Red	Walnut	Canyon Brown	Black/Orange	Black/Orange	Black/Orange	Black/Orange	
Interior color	Black	Black	Black	Black	Black	Black	Black	Black	Black	Black	Black	Black/Orange	Black	Black/Orange	
BMW exterior colors															
300 Alpine White (Non-metallic)	•	•	•	•	•	•	•	•	•	•	•	•	•	•	•
668 Jet Black (Non-metallic)	•	•	•	•	•	•	•	•	•	•	•	•	•	•	•
A61 Crimson Red (Non-metallic)	•	•	•	—	—	•	•	•	•	•	•	•	•	•	•
475 Black Sapphire Metallic	•	•	•	•	•	•	•	•	•	•	•	•	•	•	•
A76 Deep Sea Blue Metallic	•	•	•	•	•	•	•	•	•	•	•	•	•	•	•
B39 Mineral Gray Metallic	•	•	•	•	•	•	•	•	•	•	•	•	•	•	•
A75 Melbourne Red Metallic	—	•	•	•	•	•	•	•	•	•	•	•	•	•	•
B44 Valencia Orange Metallic	—	—	—	—	—	—	—	—	—	—	•	•	•	•	•
A83 Glacier Silver Metallic	•	•	•	•	•	•	•	•	•	•	•	•	•	•	•
A92 Orion Silver Metallic	•	•	•	—	—	•	•	•	•	•	•	•	•	•	•
A96 Mineral White Metallic	—	—	—	—	—	—	—	—	—	•	—	—	—	—	—
BMW interior trim															
4AD Brushed Aluminum	•	•	•	•	•	•	•	•	•	•	—	—	—	—	—
4MW Aluminum Carbon Shadow	•	•	•	•	•	•	•	•	•	•	—	—	—	—	—
4CE Anthracite Wood	•	•	•	•	•	•	•	•	•	•	•	•	•	•	•
4FE Metal Weave	—	—	—	—	—	—	—	—	—	—	•	•	•	•	•

• Recommended color combination — Not available

Leather upholstery: Leather on all seating surfaces; other components may be Leather or Leatherette.

For details on the availability of standard and optional exterior paints and upholstery materials and colors, please visit bmwusa.com/byo.

Equipment features and options.



Xenon Adaptive Headlights for high and low beams provide brilliant clarity of the road ahead and to the side at night and in conditions with poor visibility. The dynamic auto-leveling feature adjusts for varying passenger and cargo loads, helping to keep headlight glare out of the eyes of oncoming drivers.

Adaptive Headlights provide optimum road illumination around corners, thanks to an electromechanical control system that directs the headlights into and around the bend as soon as the vehicle begins cornering.

LED light rings circle both headlights and high beams, and also act separately as Daytime Running Lights and parking lights. **LED accent lights**, featuring a metal insert with BMW lettering, cut across the tops of the headlights



Exterior side-view mirrors can be folded in automatically (such as at a car wash) via the integrated electric fold-in function, then returned into position at the touch of a button. Includes auto-dimming feature, memory function, heated nozzles, and tilt-down passenger-side exterior mirror for parking ease.

Interior rear-view mirror automatically dims to reduce headlight glare from following cars.



Automatic high beams use light sensor readings to automatically switch from high to low beams according to oncoming traffic or when the road is sufficiently illuminated.

Rain sensor uses infrared light to measure the amount of rain. When the wipers are in the "intermittent" mode, the rain sensor automatically adjusts the windshield-wiping interval as needed.



Turn signal indicators integrated at the rear of the front wheel wells include tapered chrome-colored surrounds that accentuate the Z4's sporty lines.



Retractable hardtop can be easily raised or lowered in just 19 seconds at the touch of a button. The two-part hardtop folds neatly and stows in the trunk. The BMW Individual hardtop is available in a choice of two contrast colors: Jet Black and Titanium Silver Metallic.



Ambiance lighting offers conveniently placed lighting outside and inside the Z4 Roadster. Lights below the outside door handles illuminate the ground below the doors for 20 seconds after the Z4 is unlocked. Also includes interior Ambiance lighting, reading lights and footwell lighting.



Star Spoke (Style 290) 17 x 8.0 light alloy wheels with 225/45 **run-flat¹ performance tires.²**



Star Spoke (Style 276) light alloy wheels and **run-flat¹ performance tires.²** In front: 18 x 8.0 wheels and 225/40 tires; in back: 18 x 8.5 wheels and 255/35 tires.



V Spoke (Style 515) light alloy wheels and **run-flat¹ performance tires.²** In front: 18 x 8.0 wheels and 225/40 tires; in back: 18 x 8.5 wheels and 255/35 tires.



V Spoke (Style 296) light alloy wheels and **run-flat¹ performance tires.²** In front: 18 x 8.0 wheels and 225/35 tires; in back: 19 x 9.0 wheels and 255/30 tires.



Star Spoke (Style 295) light alloy wheels and **run-flat¹ performance tires.²** In front: 18 x 8.0 wheels and 225/40 tires; in back: 18 x 8.5 wheels and 255/35 tires.



Star Spoke (Style 325M) light alloy wheels and **run-flat¹ performance tires.²** In front: 18 x 8.0 wheels and 225/40 tires; in back: 18 x 8.5 wheels and 255/35 tires.



Double Spoke (Style 326M) light alloy wheels and **run-flat¹ performance tires.²** In front: 19 x 8.0 wheels and 225/35 tires; in back: 19 x 9.0 wheels and 255/30 tires.

Wheel and tire specifications are subject to change. Get the latest information on BMW standard and optional features, packages and technical specifications. Visit bmwusa.com, select the BMW model of your choice, and click on "Features & Specs."

¹ Run-flat tires do not come equipped with a spare tire and wheel.

² Driving over rough or damaged road surfaces, as well as debris, curbs and other obstacles, can cause serious damage to wheels, tires and suspension parts. This is more likely to occur with low-profile tires, which provide less cushioning between the wheel and the road. Be careful to avoid road hazards and reduce your speed, especially if your vehicle is equipped with low-profile tires. Performance tires are not recommended for driving in ice or snow conditions.

Equipment features and options.

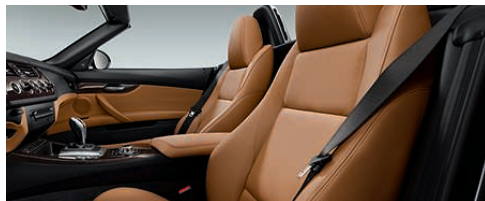

10-way manually adjustable sport seats with integrated fixed headrests can be adjusted for seat height, fore-and-aft positioning, seat tilt, backrest tilt, and two-way thigh support. The 2-way power-adjustable side bolsters as well as higher seat bolsters add lateral support during sporty driving maneuvers.



8-way power-adjustable seats with integrated fixed headrests can be adjusted for seat height, fore-and-aft positioning, seat tilt, and backrest tilt. Includes two memory buttons for the driver's seat and exterior mirrors. **Power lumbar support** adds four-way adjustable comfort for the lower back. Lumbar support can be adjusted up/down and in/out.



8-speed Sport Automatic transmission enhances the Z4 sDrive28i's sporty performance, with its quick gear shifts and immediate response to the accelerator pedal. In addition to Adaptive Transmission Control (ATC) that learns your driving style, it offers two manual shift modes: using the gear selector lever or steering wheel-mounted paddle shifters, which are automatically included. **7-speed Double Clutch Transmission** provides the Z4 sDrive35i and Z4 sDrive35i with smooth, lightning-quick gear changes by automatically shifting between two transmission structures. While one gear is disengaging, the next is already in position. The result is both quicker acceleration and enhanced fuel efficiency. (Includes steering wheel-mounted paddle shifters.)



Driving Dynamics Control allows you to tailor the Z4's performance by selecting COMFORT, SPORT or SPORT+ driving mode at the touch of a switch. This changes throttle response, steering assist, suspension damping (with Adaptive M Suspension) and automatic transmission shifting. Additionally, you can deactivate Dynamic Stability Control (DSC) and switch to Dynamic Traction Control (DTC), which allows wheelslip within defined limits when driving in deep snow, or for a sportier driving style.

Adaptive M Suspension lowers the chassis by 0.4 inches and electronically adjusts the dampers from sportingly tight to relaxed and comfortable, for greater agility and precise response.



6-speed manual transmission is smooth and optimally synchronized. Developed specifically for the Z4 Roadster, it features precise, short-throw gear shifts for an athletic driving experience. The narrow transmission ratios with an additional sixth gear make the engine even more responsive to your personal driving style.



3-spoke leather-wrapped multi-function sport steering wheel lets you keep both hands on the wheel while changing radio stations, CD selections, volume, and making mobile phone calls.



Multi-function steering wheel buttons on the left side operate the cruise control functions, while those on the right side control all audio functions, such as the radio and BMW-approved Bluetooth® mobile phone and Voice command.



Multi-function leather-wrapped M steering wheel includes paddle shifters when equipped with the Sport Automatic transmission or 7-Speed Double Clutch Transmission. An M shift lever knob with M emblem is also included when equipped with the 6-speed manual transmission.



Premium Sound Package anti-theft AM/FM/CD player generates full-bodied sound. Two-line readout displays names, audio and MP3 tracks. Includes Sirius Satellite Radio with one-year subscription.

BMW anti-theft AM/FM stereo/CD/MP3 player (not shown) includes Radio Data System, reads/displays song title, Auto-Store and 3-channel FM diversity antenna.

HD Radio™ receives free, digital AM/FM broadcasts across the U.S. in clear, static-free quality sound – AM sounds like FM; FM sounds like CD. Also enjoy "multicast" FM stations, as well as a variety of innovative data services. (For more information on HD Radio, visit HDRadio.com.)



Air conditioning provides an ideal environment year-round. Includes micro-filter, manual temperature adjustment and air recirculation, seven fan speeds, and knee-level vents.

Automatic climate control system allows each occupant to select their preferred temperature, as well as automatic or manual airflow and recirculation. The automatic recirculation control activates whenever certain air pollutants are detected. The system also offers a convertible mode for when the roof is down; micro-filter; defrost/defog and MAX A/C functions; sun and rain sensor; and auxiliary ventilation.



Navigation system features a pop-up, high-resolution, glare-free monitor. When not in use, it retracts back down, out of sight. Features include 3-D daytime and nighttime maps, zoom, travel planner, and an Assistance Window. The hard drive offers 12 GB of space that can hold up to 2,000 songs. It also provides Real Time Traffic Information on potential traffic problems and solutions.

Voice command lets you select radio stations, Navigation destinations, initiate mobile phone calls and more without taking your attention away from traffic.

Get the latest information on BMW standard and optional features, packages and technical specifications. Visit bmwusa.com, select the BMW model of your choice, and click on "Features & Specs."

Equipment features and options.



Smartphone Integration lets you snap in your Bluetooth® enabled mobile phone to make hands-free calls while recharging. Includes a connection for the charger and external antenna for enhanced reception.

Auxiliary input port lets you connect an external audio source, such as an iPod or MP3 player.



Storage options abound in the Z4. In addition to the storage bench behind the seats, there are fold-out storage compartments in both doors, two storage trays in the center console, a storage compartment in the dash (not available with Navigation system), one under the center console, and a spacious glove compartment.



Premium speaker system fills the cabin with rich surround sound. The multi-channel digital amplifier adjusts the surround sound to the internal dimensions of the vehicle; when equipped with the Navigation system, sound can be adjusted to simulate a church, hall or jazz club.



Luggage compartment is surprisingly spacious for a roadster. With the hardtop down, the trunk holds 6.4 cu. ft. Put the top up, and it holds 10.9 cu. ft. – enough to hold a 46-inch golf bag. A movable partition, unique in the premium roadster class, creates enough room for a medium-size suitcase with the roof down – and much more with the roof up.



Through-loading system with integrated ski bag is an ideal way to expand the Z4 Roadster's stowing capabilities. It cleanly and securely holds two pairs of 67-inch skis and ski poles, or a 46-inch full-size golf bag. With the hardtop up, a second 46-inch golf bag can be stowed in the trunk. When using the through-loading system, the removable cover can be locked in position.



Storage package maximizes the Z4's carrying capabilities. In the cabin, fastening nets are located in the passenger's footwell area and behind the seatbacks; a handy clothes hook is on each roll bar. In the trunk, cargo can be held down by lashing belts, and there is a convenient partition storage compartment that fits into the through load opening.



Comfort Access system offers convenient keyless access to your vehicle. Carrying the remote key fob in a pocket or purse allows you to unlock the doors by touching the door handle.

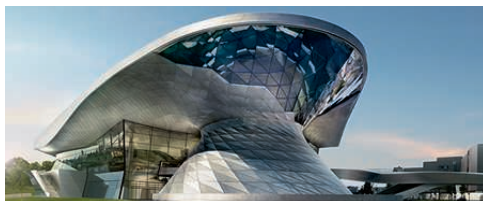

BMW Welt. Take delivery of your new Z4 Roadster where it was born: in Europe. When you sign up for the BMW European Delivery Program, your first stop in Munich, Germany, is the BMW Welt – home to an automobile delivery center, automobile exhibitions, and an event hub all under one roof. Learn more about this unforgettable experience at bmwusa.com/europeandelivery.

Get the latest information on BMW standard and optional features, packages and technical specifications. Visit bmwusa.com, select the BMW model of your choice, and click on "Features & Specs."

BMW Z4 CONTRASTING ROOF – THE FINISHING TOUCH.

Like the perfect hat, the sleek BMW Individual hardtop emphasizes the unique personality of your Roadster. Choose the Jet Black hardtop to underscore your car's sporty nature, or add the gleam of Titanium Silver Metallic to show off the Z4's more elegant aspects. Whichever you select, the dynamic contrast between the hardtop color and body color makes for a truly dramatic statement.



BMW Individual hardtop in Jet Black.

BMW exterior colors	Alpine White (Non-metallic)	Crimson Red (Non-metallic)	Mineral White Metallic	Glacier Silver Metallic	Ocean Silver Metallic	Melbourne Red Metallic	Valencia Orange Metallic	Jet Black (Non-metallic)	Mineral Grey Metallic	Deep Sea Blue Metallic	Black Sapphire Metallic
BMW Individual hardtop colors	Jet Black (Non-metallic)	Jet Black (Non-metallic)	Jet Black (Non-metallic)	Jet Black (Non-metallic)	Jet Black (Non-metallic)	Jet Black (Non-metallic)	Jet Black (Non-metallic)	Titanium Silver Metallic	Titanium Silver Metallic	Titanium Silver Metallic	Titanium Silver Metallic



The contrasting roof emphasizes the Z4's classic roadster proportions.

Original BMW Accessories.



18" Star Spoke (Style 276) light alloy wheels and Foldable Rear Bicycle Carrier. This high-quality Bicycle Carrier can hold up to three bikes. The lightweight, compact design allows for the carrier to be folded and stored when not in use. It secures to the Z4 Roadster using an integrated Click-On attachment for a clean look and easy removal. (European model shown.)



Illuminated Doorsills light up each time the door is opened – like the face of a Z4 driver.



Z4 Embroidered Floor Mats, made of thick pile carpet, are embossed with the Z4 logo.



BMW Performance High-Gloss Black Kidney Grille underscores the aggressive look of your BMW Z4 Roadster.

CRAFT YOUR OWN BMW – AT [BMWUSA.COM/BYO](https://www.bmwusa.com/byo).



At BMW, we want you to create your own Ultimate Driving Machine®. That's why BMW offers one of the widest model ranges of any luxury automotive manufacturer. And each BMW model offers its own universe of personalizing possibilities.

It's easy to get the latest information on your favorite BMW model. Simply visit [bmwusa.com](https://www.bmwusa.com) and click on the BMW model of your choice. Select **"Features & Specs"** to see all the standard features and available options and packages, as well as technical specifications.

Then create the exact BMW model that fulfills your needs by clicking on **"Build Your Own"** – or just visit [bmwusa.com/byo](https://www.bmwusa.com/byo). Here you'll be able to select from among the many interior and exterior colors and trims, personalizing options and value-added packages. Build a BMW model that reflects your style, then view it in 360° detail. At the press of a button, see payment and financing options, get a same-day quote, download a product brochure and even schedule a test drive. BMW makes it easier than ever to make your ultimate driving dreams come true, at [bmwusa.com](https://www.bmwusa.com).

Driving a BMW is always a special experience. Enhance it further with Original BMW Accessories. Benefit from innovative solutions combining unique ideas, stunning design and supreme functionality. Discover the wide range of Original BMW Accessories available to you, enhancing such vehicle aspects as the exterior, interior, technology, transporters, protection and details to customize your vehicle. For additional information on Original BMW Accessories, please visit your authorized BMW center or shopbmwusa.com.

		Z4 sDrive28i	Z4 sDrive35i	Z4 sDrive35is
--	--	--------------	--------------	---------------

Weight

Unladen	lbs	3263 (3307)	3494 [3527]	[3549]
Weight distribution, front/rear				
Manual transmission	%	47.3/52.7	48.6/51.4	—
Automatic transmission	%	(47.7/52.3)	[49.1/50.9]	[49.4/50.6]

Engine

liter/type/valves per cylinder		2.0/TwinPower Turbo inline 4/4	3.0/TwinPower Turbo inline 6/4	3.0/TwinPower Turbo inline 6/4
Bore/stroke	in	3.3/3.5	3.3/3.5	3.3/3.5
Nominal output/rpm	hp	240/5000	300/5800	335/5900
Max torque/rpm	lb-ft	260/1250-4800	300/1400-5000	332/1500 ¹
Compression ratio	:1	10.3	10.2	10.2

Transmission

Manual gear ratios	I/II/III:1	3.68/2.06/1.31	4.06/2.40/1.58	
	IV/V/VI:1	1.0/0.81/0.68	1.19/1.0/0.87	
	VII/VIII/R:1	—/—/3.35	—/—/3.68	
Final drive ratio	:1	3.08	3.08	
Automatic gear ratios	I/II/III:1	4.71/3.14/2.15	4.78/3.06/2.15	4.78/3.06/2.15
	IV/V/VI:1	1.67/1.29/1.00	1.68/1.39/1.20	1.68/1.39/1.20
	VII/VIII/R:1	0.84/0.67/3.30	1.0/4.45	1.0/4.45
Final drive ratio	:1	3.73	2.56	2.56

Performance

Top speed (limited electronically)	mph	130/155 ²	130/155 ²	[155]
Acceleration 0-60 mph ³	sec	5.5 (5.6)	5.1 [5.0]	[4.8]

Fuel consumption⁴

Manual transmission – city/highway	mpg	22/34	19/26	—
Automatic transmission – city/highway	mpg	(22/33)	[17/24]	[17/24]
Fuel capacity	gal	14.5	14.5	14.5

Wheels

Tire dimensions	front	225/45 R 17 W	225/45 R 17 W	225/40 R 18 W
	rear	225/45 R 17 W	255/40 R 17 W	255/35 R 18 W
Wheel dimensions		8 J x 17	8/8.5 J x 17	8/8.5 J x 18
Material		Light alloy	Light alloy	Light alloy

Figures in () apply to Sport Automatic transmission.
Figures in [] apply to 7-speed Double Clutch Transmission (DCT).

¹ An additional 37 lb-ft of temporary torque is delivered with the standard turbo boost function.

² Top speed with the M Sport Package, M Sport/Canyon Brown Package and M Sport/Hyper Orange Package.

³ BMW test results. Actual acceleration results may vary depending on specification of vehicle, road and environmental conditions, testing procedures and driving style.

⁴ These results should be used for comparison only and verification should not be attempted on public roads. BMW urges you to obey all posted speed laws and always wear safety belts.

⁵ Preliminary figures. Please go to bmwusa.com for latest available information. Figures are for comparison purposes only. Your actual mileage will vary, depending on speed, driving habits, trip length and driving conditions; actual mileage will most likely be lower.

⁶ Z4 sDrive35is: 50.6 inches.

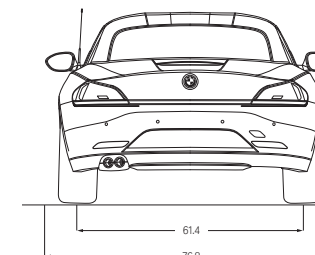
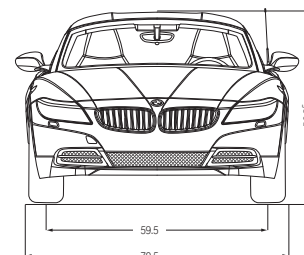
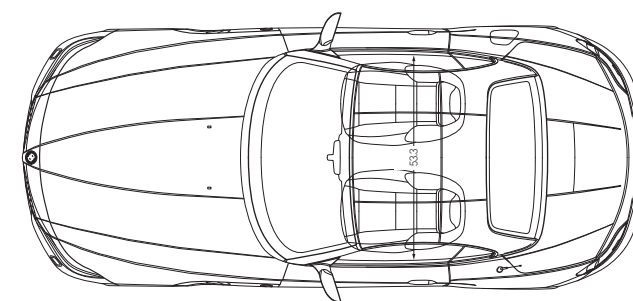
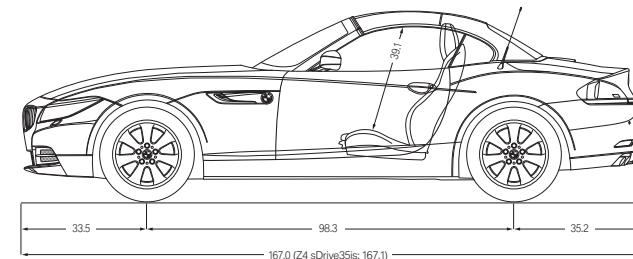

All dimensions in the technical drawings are given in inches for Z4 sDrive28i and Z4 sDrive 35i.

U.S. Importer: BMW of North America, LLC, Woodcliff Lake, NJ 07677. All illustrations and specifications contained in this brochure are based on the latest product information available at the time of printing. BMW reserves the right to make changes at any time, without notice, in colors, materials, equipment, specifications, design and models. BMW may, subject to legal requirements, determine the Model Year designation of its vehicles. The Model Year designation on any particular model may be longer or shorter than 12 months. Some vehicles pictured may contain non-U.S. equipment. Some models may be shown with optional equipment. While BMW NA makes all reasonable efforts to provide accurate information in this brochure, there is no guarantee or warranty of accuracy. Furthermore, we do not assume any liability for the accuracy or completeness of information presented. This brochure shall not be used or relied upon as a substitute for information that is available from your authorized BMW center. Further information can be obtained from your authorized BMW center or bmwusa.com.

©2013 BMW of North America, LLC. Not to be reproduced wholly or in part without written permission of BMW NA. The BMW name, model names and logo are registered trademarks.

The Bluetooth word mark and logos are owned by the Bluetooth SIG, Inc. and any use of such marks by BMW is under license. iPhone and iPod are registered trademarks of Apple Inc. Other trademarks and trade names are the property of their respective owners.

We believe that a premium ownership experience should feature performance and luxury, as well as safety and convenience. We believe you should be able to drive a BMW to its potential, while enjoying peace of mind and reduced cost of ownership. That's the idea behind **BMW Ultimate Service**[®]: a suite of comprehensive programs and services that are included in every new BMW vehicle.

BMW Ultimate Service starts with the **New Vehicle/SAV Limited Warranty**,¹ providing you with coverage for the first four years or 50,000 miles, whichever comes first. Additionally, you have 12-year, unlimited-mileage warranty protection against corrosion and rust perforation.¹ The **BMW Maintenance Program**,² **BMW Assist eCall**^{™3} and **BMW Roadside Assistance** also come standard.

GOING BEYOND ENGINEERING: THE HIGH-PERFORMANCE BMW OWNERSHIP EXPERIENCE.

BMW Maintenance Program

is one of the most comprehensive maintenance programs in its class. We cover all factory-recommended maintenance during the New Vehicle/SAV Limited Warranty coverage period. This includes scheduled oil services and inspections. Also covered is the replacement of items that are subject to normal wear and tear, such as brake pads, wiper blade inserts and engine drive belts.² And, thanks to BMW's advanced engineering, most owners enjoy a well-balanced maintenance schedule, with flexible routine service intervals that can save you time. When your vehicle requires attention, your authorized BMW center ensures that it receives only genuine BMW parts – your assurance of exacting quality standards.

For more details on BMW Ultimate Service and the BMW Maintenance Program, visit your authorized BMW center or log on to bmwusa.com/ultimateservice.

BMW Assist eCall,³ a safety feature

of BMW ConnectedDrive, lets you enjoy peace of mind knowing that a friendly response specialist is there to help you, 24/7, at just the push of a button. (This includes Emergency Request (SOS button), Automatic Collision Notification, and Customer Relations. **BMW TeleService**³ continually monitors specific vehicle parts that are subject to wear and tear, as well as services that require attention at regular intervals, such as vehicle service inspections. This data is automatically transmitted to your authorized BMW center, which informs a BMW Service Advisor to call and schedule a convenient service appointment. You don't have to keep track of when your vehicle requires routine maintenance. An added benefit: any needed maintenance service parts will already be on hand, so your BMW is serviced and returned to you as quickly as possible. And because they use only Original BMW Parts, you can rely on expert fit and long-lasting BMW quality.

BMW Roadside Assistance

is provided free of charge for the first four years – with no mileage limit. Call **1-800-332-4BMW (4269)** for friendly on-the-road help, 24/7, anywhere in the United States, Canada and Puerto Rico. This includes everything from flat-tire changes, emergency gasoline and lock-out service, to towing, alternative transportation and even trip-interruption benefits. This service also provides valuable trip-routing advice.

BMW Online⁴ provides up-to-date web information: business and stock reports, as well as weather updates. BMW Online also includes **MyInfo**, which allows you to send business locations and street addresses with their associated phone numbers from the Google Maps[™] website directly to your BMW. The destination can be sent to your Navigation system for turn-by-turn directions.

Enhanced USB and Bluetooth[®] with Smartphone Integration offers an array of Mobile Office⁵ functions. With the BMW Navigation system and your mobile phone linked via Bluetooth technology, Mobile

Office transfers text messages and emails to your iDrive Display screen and then reads them aloud to you. While en route, a calendar and to-do list can also appear on your Display screen. Running late? Click on the phone number in the calendar to call your appointment. For a list of tested mobile phones, visit bmwusa.com/bluetooth.

Remote Services² include Remote Door Unlock, Stolen Vehicle Recovery, and access to the My BMW Remote app, which allows you to control your BMW from your mobile device.

For the ultimate in coverage, add the optional **Concierge Services**.⁶ You'll enjoy unlimited access to personalized Directions and services for restaurant and hotel recommendations, with the destination address and phone number not only sent right to your BMW, but also transferred to your Navigation system for route guidance. Another useful Concierge feature: **Critical Calling**. This lets you make up to four operator-assisted calls per year, up to five minutes per call, if your mobile phone is not available, or if its battery is discharged.



BMW Virtual Center. If you get the sudden urge to shop for a BMW but your authorized BMW center is closed, there's good news – the BMW Virtual Center is open 24 hours a day! Log on to bmwusa.com/byo, and choose the model that interests you. Configure the BMW of your dreams, and see what the monthly payments would be. You can even send the specifications to your authorized BMW center, apply for financing, or request a test drive – all online!

BMW Financial Services. Arranging to buy or lease a BMW is easier than you may think. Your authorized BMW center offers leasing and financing to suit your personal needs through BMW Financial Services.⁷ Start the process at our website, where you can build your "dream vehicle," get an estimate on a monthly lease or financing payment, submit a credit application to BMW Financial Services – and get approval – all online!⁷ To find out how BMW Financial Services can help put you behind the wheel of your favorite BMW model, log on to bmwusa.com/fs or call, toll-free, **1-800-578-5000**.

BMW Magazine. A fascinating view of the latest events and products in the world of BMW, including travel reviews, personality profiles, and the latest BMW technologies. Sent to new owners and lessees twice a year, you can also read articles from **BMW Magazine** on the BMW website at bmwusa.com under the "Explore BMW" heading, found in the "News" section under "Magazines."

The **BMW Welt** ("BMW World") delivery and brand-experience center in Munich is bold proof of BMW's passion for design. When you take advantage of the BMW European Delivery Program,⁸ this is where you will meet your new BMW – in a personalized process that is highly dramatic and totally unforgettable. (You might also realize substantial savings that just may pay for your trip.) While you're there, marvel at the historic BMWs in the Museum; learn about our engineers' recent innovations in the Technology and Design Atelier; and take a tour of the plant to experience firsthand the state-of-the-art methods used to create a BMW. Then comes the unique experience of driving your new BMW on the roads it was designed for. To learn more, visit bmwusa.com/europeandelivery.

¹ See your authorized BMW center for details on these limited warranties.

² The BMW Maintenance Program covers factory-recommended maintenance services as determined by the Service Interval Indicator for all new eligible MY 2004 and later BMW vehicles. Specific additional items that need replacement due to normal wear and tear are also covered. The maintenance coverage period is for the first 4 years or 50,000 miles, whichever comes first. Exclusions from coverage include: gasoline, gasoline additives, windshield washer fluid and additives, battery, tires, wheels, wheel alignment and tire balancing. All work must be performed by an authorized BMW center. See the Service and Warranty Information booklet for specific terms, conditions and limitations. Further information can also be obtained from your authorized BMW center.

³ On 2014 and later BMW Z4 Roadster models, BMW Assist eCall and BMW TeleService are standard and include 10 years of service. Remote Services (included in Technology Package) includes 10 years of service. In order to receive these services, a subscriber agreement must be completed and transferred to the BMW Assist Response Center. GPS and underlying wireless services must be available and functioning, vehicle ignition must be turned on (except for Remote Services), battery must be charged and connected, and vehicle's electrical system operational. Due to wireless carrier coverage, services may be limited in certain geographic areas. Call toll-free **1-888-333-6118**, go to bmwassist.com, or visit your authorized BMW center for additional program details. Services are subject to the terms and conditions of your subscriber agreement.

⁴ BMW Online comes with a 3-year subscription and is included in Technology Package. Subject to the terms and conditions of your subscriber agreement. Please go to bmwusa.com/connecteddrive for additional details on BMW Online.

⁵ Not all mobile phones are compatible with Mobile Office, and some compatible phones support a limited number of Mobile Office functions. For the complete list of compatible mobile phones and the details regarding which Mobile Office functions are supported by each phone, please visit bmwusa.com/bluetooth.

⁶ Concierge Services (optional and requires Technology Package) comes with a 3-year subscription. Subject to the terms and conditions of your subscriber agreement. Please go to bmwusa.com/connecteddrive for additional details on Concierge Services.

⁷ Subject to credit approval and other terms and conditions.

⁸ Not all models available for BMW European Delivery Program. Please go to bmwusa.com/europeandelivery or visit your authorized BMW center for details.



THE MOST EXCITING PLACE IN AMERICA TO DRIVE A BMW.

The BMW Performance Center in Spartanburg, SC.

Just beyond the foothills of the Carolinas' Blue Ridge Mountains lies the \$12 million BMW Performance Center. This sprawling, modern complex houses the world-famous BMW Performance Driving school, as well as the Zentrum Museum, BMW Boutique, BMW Delivery Center, and a Corporate Conference Center. Nearby is BMW's only manufacturing facility in the U.S., where models, such as the SAV,[®] are built for export worldwide. It's a unique place where BMW enthusiasts can spend days – or, in the surrounding area, an entire vacation.

BMW Performance Driving School.

Take your driving skills to the next level. Behind the wheel of new BMWs and under the guidance of professional instructors, you'll hone your driving skills on a 1.7-mile driving course that can be configured in a multitude of ways. In One- and Two-Day Schools you can tackle the skid pad, slalom course and water walls. The BMW Performance Driving School is about control and pushing a BMW to its limits – and yours. Visit bmwusa.com/pds.

BMW Performance Center Delivery.

You'll always remember the fun of taking delivery of your new BMW – especially with BMW Performance Center Delivery in Spartanburg, SC. After enjoying dinner and an overnight stay at a first-class hotel, we'll take you and your companion to the Performance Center where a Product Specialist will give you an in-depth introduction to your new BMW. Then at the Performance Driving School, you'll get tips from a professional driving instructor as you explore the dynamic capabilities of a similar model. It's exciting, it's enlightening – and it's all compliments of BMW with your new vehicle. To learn more about the BMW Performance Center, call **1-888-345-4269** or visit bmwusa.com/pdsdelivery.

More about BMW



The Ultimate
Driving Machine®

bmwusa.com
1-800-334-4BMW



BMW and the environment.

BMW is a strong proponent of the environment and social responsibility. We launched BMW EfficientDynamics back in 2000 – the philosophy of providing greater power with increased efficiency and fewer emissions. This has resulted in significant benefits today – for our customers, the climate and the environment.

That year, ecological sustainability was also declared one of BMW's core strategic principles; it is now firmly anchored in our entire production chain. It starts with the development of fuel-saving and alternative vehicle concepts, continues with environmentally friendly production processes, and ends with innovative recycling methods. This effort has been recognized worldwide; in 1999, BMW AG – the parent company of BMW of North America and BMW Manufacturing Co. in Spartanburg, SC – was the first automotive company to be represented on the Dow Jones Sustainability Group Index. It has remained on the Index ever since; moreover, since 2005, BMW has been voted the world's most sustainable automobile manufacturer. At BMW, we strive for and achieve high performance in all we do.



BMW recommends **EDGE**