



2013  
ALL-NEW CADILLAC XTS



XTS

EXTERIOR

LIGHTING

INTERIOR

CUE

SAFETY TECHNOLOGY

PERFORMANCE

COLLECTIONS

COLOR

WHEELS & SPECS



*INDIVIDUALLY,  
ITS INNOVATIONS ARE INGENIOUS.  
TOGETHER, THEY'RE UNPRECEDENTED.*



**AVAILABLE LED SIGNATURE  
LIGHTING**



**CUE**





The XTS redefines the principles of what's possible, beginning with the groundbreaking CUE<sup>1</sup> driver interface. Employing first-of-its-kind technology, CUE brings the intuitive control of smartphones and tablets conveniently to the road. The inspired thinking also extends to available XTS safety technologies like its perimeter warning that helps alert you to obstacles and hazards in your path. Under the artfully sculpted hood, the 3.6L direct-injection V6 delivers a refined 304 HP, while available advanced All-Wheel Drive and the rear electronic Limited-Slip Differential (eLSD) responsively put power where you need it, when you need it.



A detailed view of the Cadillac XTS interior, showing the leather-upholstered dashboard, the CUE infotainment system with a large touchscreen, and the instrument cluster. The steering wheel is partially visible on the left. The background shows a blurred view of a car in a showroom.

## GET THE LATEST FROM CADILLAC

Get news, events, info and updates—  
all in a monthly e-mail.

[SIGN UP >>](#)

The XTS redefines the principles of what's possible, beginning with the groundbreaking CUE<sup>1</sup> driver interface. Employing first-of-its-kind technology, CUE brings the intuitive control of smartphones and tablets conveniently to the road. The inspired thinking also extends to available XTS safety technologies like its perimeter warning that helps alert you to obstacles and hazards in your path. Under the artfully sculpted hood, the 3.6L direct-injection V6 delivers a refined 304 HP, while available advanced All-Wheel Drive and the rear electronic Limited-Slip Differential (eLSD) responsively put power where you need it, when you need it.









XTS

EXTERIOR

LIGHTING

INTERIOR

CUE

SAFETY TECHNOLOGY

PERFORMANCE

COLLECTIONS

COLOR

WHEELS & SPECS

XTS PLATINUM COLLECTION / Graphite Metallic

Where is it written that head-turning presence and formidable performance be restricted only to two-door coupes? The chiseled, angular skin of the XTS was designed not only to turn heads, but to slice through the wind, helping improve performance and mitigate noise. Its distinctive, sloping grille is integrated into the overall design so seamlessly, the final effect is both subtly detailed and yet convincingly stated. Of course, its assertive stance and striking vertical rear taillamps make a bold statement, but when you spot the massive front Brembo® brakes lurking behind the spoked alloys, it becomes clear this is a Cadillac to be reckoned with.





INSPIRING

DESCRIBES MORE THAN THE DRIVE.



XTS PLATINUM COLLECTION / Graphite Metallic

*WHEN IT COMES TO THE DETAILS,  
WHERE DO YOU STOP?  
YOU DON'T.*







### ***DIRECTIONAL HID HEADLAMPS***

The brilliant High-Intensity Discharge (HID) headlamps are available with Adaptive Forward Lighting. This technology directs the headlamps to cast light precisely into your path of travel.



### ***DYNAMIC 20" WHEELS***

Featuring a brilliant, polished finish and chrome inserts, these 20" Platinum Collection wheels are the ideal complement to the XTS.

A PERFORMANCE THIS IMPRESSIVE

DESERVES LIGHTING TO MATCH.







### **ILLUMINATED DOOR HANDLES**

Refined details are everywhere, right down to the available illuminated door handles. More than an accent, their soft glow makes them easier to locate. Once you are in the vehicle, they return to their non-illuminated state.



### **PUDDLE LAMPS**

Subtle lamps located under the outside mirrors cast a light near the entrance of the car as part of the carefully choreographed lighting sequence, so your path is well lit.



### **ILLUMINATED SILL PLATES**

In the XTS, every detail was considered. For example, upon opening either front door in the Platinum Collection, backlit sill plates are an inviting touch.

With the XTS setting the perfect stage for an exhilarating performance, it's fitting the lighting was designed as if it were a contemporary theater. Every piece of illumination was choreographed with a specific task in mind, whether it is to draw your eye to the meticulous details or to add illumination to key areas. Taken individually, each light is impressive in its own right, like the signature Cadillac light pipe technology integrated into the headlamps and taillamps. They form a razor-thin blade that is clearly evident at night—making your vehicle visible and distinctive from any angle. When backing up, there's a lower-mounted reverse lamp to improve your view. Even the available illuminated exterior door handles add a purposeful touch on a dark night.





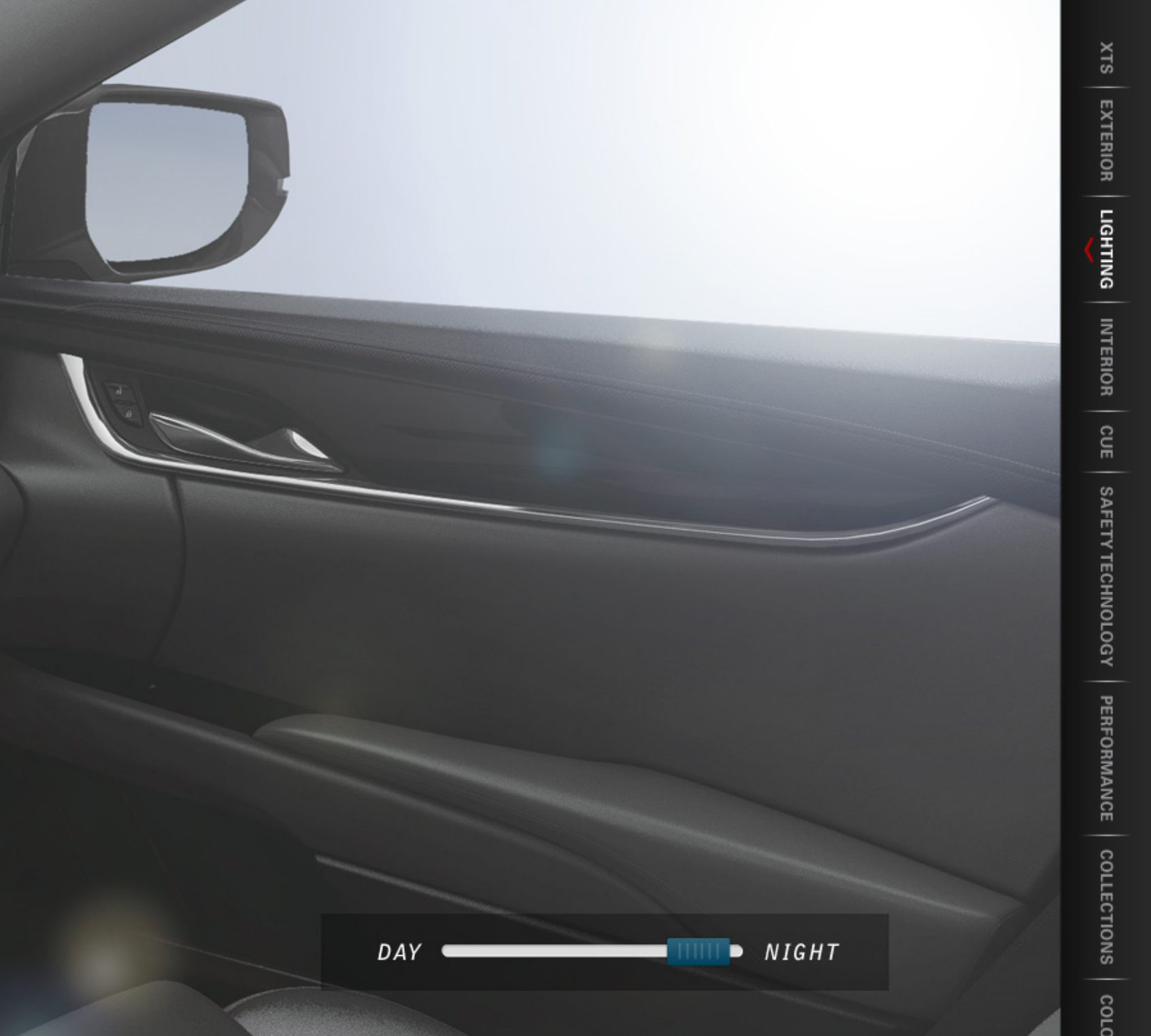

DAY

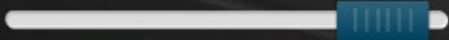

NIGHT

### ***AMBIENT INTERIOR LIGHTING***

Experience how the available ambient interior lighting adds drama and illumination to the ingenious cabin details inside the XTS.



*EVEN THE FINE POINTS HAVE  
FINER POINTS.*

The first moments behind the wheel are, in many ways, the most inspiring. It is why we designed the XTS to feel more like a perfectly tailored garment. You wear it, feel it, think it. There's the wraparound instrument panel that blends seamlessly into the upper doors, creating an uninterrupted sense of spaciousness. To that, add fine leather seating surfaces, exotic woods and brushed metal that work in concert to further accentuate the cabin. Even the spacious backseat with best-in-class rear legroom is slightly elevated so every passenger is afforded a seat with a view. It may feel as if every interior detail was designed to meet your personal specifications. Perhaps that's because it was.





- XTS
- EXTERIOR
- LIGHTING
- INTERIOR**
- CUE
- SAFETY TECHNOLOGY
- PERFORMANCE
- COLLECTIONS
- COLOR
- WHEELS & SPECS

*XTS PLATINUM COLLECTION / Jet Black with Light Wheat accents*

A close-up photograph of black leather car seats. The leather has a fine, pebbled texture. Two prominent diagonal lines of stitching run across the frame, one in the upper right and one in the lower left. The stitching is a vibrant purple color, creating a sharp contrast with the dark leather. The lighting is dramatic, highlighting the texture and the sheen of the leather.

***OPUS FULL-LEATHER SEATS***

Opus full-leather seating is exclusive to Platinum Collection models. This unique, luxurious leather is renowned for its ultra-soft feel and refined appearance.



*THE LINING OF A SUIT.*

*THE MOVEMENT OF A WATCH.*

# *TRUE LUXURY CAN OFTEN BE FOUND ON THE INSIDE.*

The meticulous attention to detail continues into the striking cabin. Intuitive controls are complemented with impeccably detailed materials like lustrous exotic wood that trims the steering wheel and is carefully laid throughout the center console. Laminated front side glass and triple door seals work in tandem to help deflect noise before it enters the cabin. And to optimize seat comfort, pressure-mapping technology was used extensively to design the contoured front seats. Proof that in the XTS, technology definitely comes with a sophisticated side.



## ***THE ART OF DETAIL***

The closer you look, the better it gets. Leather surfaces, contrasting stitching, beautifully grained woods and brushed metal all come to life in the XTS.



## ***INTELLIGENTLY DESIGNED STORAGE***

From the smartly placed mobile device holder to the center control panel that opens, every millimeter of the XTS reveals yet another brilliantly engineered space.

The image shows the rear passenger area of a car. Two black leather seats with white stitching are visible. The seats have a modern, angular design. The car's interior is dark, with wood trim on the door panels. The view is from the passenger side looking towards the driver's side.

**XTS**

**AUDI A6**

**MERCEDES E350 SEDAN**

***REAR LEGROOM***

In the all-new XTS, every seat is one to be preferred. Compare its best-in-class rear legroom against our competitors to see how the XTS sets another new standard.





40.0"

*THE SOUND DOESN'T SURROUND YOU.*

*IT IMMERSSES YOU.*







**BOSE® PERSONAL® SURROUND SPEAKERS**



**14-SPEAKER BOSE STUDIO SURROUND® SOUND SYSTEM**

Your choice seats to a remarkable musical event are ready. Deep, powerful lows. A wide, spacious soundstage. All the emotion and dynamics of a live performance now rendered in a remarkable surround sound experience. And it's all brought to you by the 14-speaker Bose Studio Surround sound system in the Premium and Platinum Collections. Customized for the unique acoustic environment of the XTS, it uses two Personal surround speakers on the top of each front seat to provide an immersive and individual sound experience. Of course, no matter where you are sitting, you'll enjoy rich, detailed sound that seems to extend well beyond the space. With its proprietary speakers, powerful amplifier and AudioPilot® noise compensation technology, this system puts you in the middle of the music.

INTELLIGENCE,

IN ITS SIMPLEST FORM.



72°

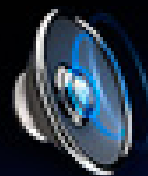

AUDIO



NAV



PANDORA



WEATHER



1. Full functionality requires compatible Bluetooth and smartphone. Some devices require USB connectivity.  
2. Map coverage available in the United States, U.S. Virgin Islands, Puerto Rico and Canada. 3. Requires active SiriusXM subscription. 4. Data plan rates apply.





Introducing CUE<sup>1</sup>, which blends innovative technology with highly intelligent design to create an experience that's as effortless as it is advanced. It easily accesses every contact and song on up to ten Bluetooth<sup>®</sup>-enabled smartphones. The available 3-D GPS navigation system<sup>2</sup> has

map-integrated Doppler weather<sup>3</sup> reports. CUE also streams Pandora Radio<sup>4</sup> and lets you preset up to 60 favorites, including points of interest, addresses, phone numbers, and more. With CUE, the customization and content possibilities are not only endless, but right at your fingertips.

ONE PART DRIVER INTERFACE, ONE PART ENTERTAINMENT SYSTEM, CUE REIMAGINES THE CONNECTION BETWEEN CAR AND DRIVER.



1. Requires active SiriusXM subscription. 2. Data plan rates apply. 3. Go to [gm.com/bluetooth](http://gm.com/bluetooth) to find out which phones are compatible with the vehicle. 4. Map coverage available in the United States, U.S. Virgin Islands, Puerto Rico and Canada.



**CONVENIENCE**

A clean, uncluttered design pairs with Natural Voice Recognition for effortless interaction. CUE is as easy and intuitive to use as your smartphone or tablet.

**CONTROL**

Seemingly instinctive, CUE uses proximity-sensing technology to detect your hand as it nears the LCD touch screen. Once there, press an icon, and the screen pulses to acknowledge your prompt, helping you to stay focused on the road.

**CONNECTIVITY**

Doppler-radar weather,<sup>1</sup> Pandora Radio,<sup>2</sup> Bluetooth<sup>®</sup> connectivity,<sup>3</sup> available 3-D GPS navigation<sup>4</sup>, and more.





# VISION, IN EVERY SENSE OF THE WORD.

The best safety features are those that help you avoid a collision in the first place. That's why the XTS offers the latest innovations in driver awareness and assistance to help inform you of potential hazards you may not even see. Using radar technology and strategically placed cameras, the XTS is ever-vigilant with its available Forward Collision Alert, Lane Departure Warning, Side Blind Zone Alert<sup>1</sup>, Rear Cross-Traffic Alert, and Front and Rear Park Assist. Even the available Adaptive Cruise Control<sup>2,3</sup> uses radar to maintain a preset distance between you and other vehicles. And the available Front and Rear Automatic Braking<sup>3</sup> detects large objects you may not see to help prevent certain low-speed collisions by applying the brakes for you.

1. Before making a lane change, always check the SBZA display, check the side and inside mirrors, look over your shoulder for vehicles and hazards, and activate your turn signal. 2. Adaptive Cruise Control is no substitute for the driver's personal responsibility to operate the vehicle in a safe manner. The driver needs to remain attentive to traffic and road conditions and provide the steering, braking or other inputs necessary to retain control of the vehicle. 3. Late availability.





### **RADAR TECHNOLOGY**

To calibrate its available safety systems, Cadillac engineers pushed the radar sensors to their limits with rigorous test-runs across the vaunted Brooklyn Bridge. Known for its massive amounts of metal—which can cause interference—Cadillac developed an ultra-responsive safety system calibrated for the real world.

*A SAFETY SYSTEM SO ADVANCED,  
WE HAD TO INVENT A NEW SEAT  
TO TELL YOU ABOUT IT.*

With select models featuring eight ultrasonic motion detectors, six Doppler radar sensors and a high-definition Smart Camera taking twelve pictures every second, the XTS doesn't just watch the road. It analyzes it. Cross-references it. Writes a dissertation. And then leaves you with the condensed version. All through subtle pulses in your driver's seat.

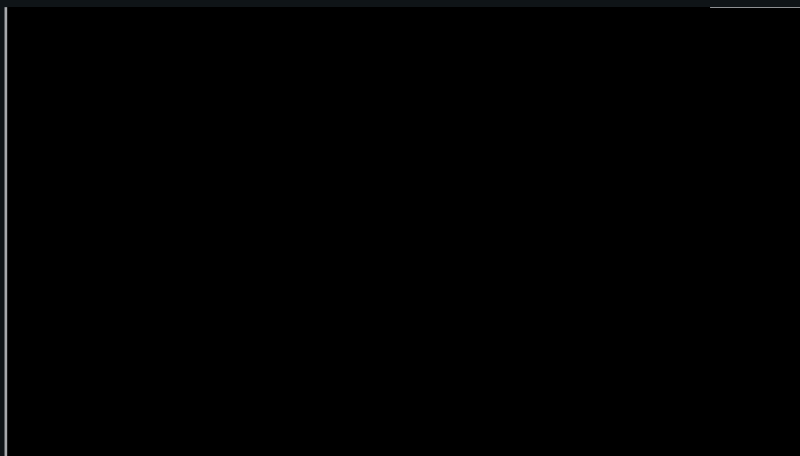

**BELLS & WHISTLES**

As an alternative to warning chimes, the XTS offers the patented Safety Alert Seat. It gives you a warning you can actually feel to alert you of select dangers on the road.

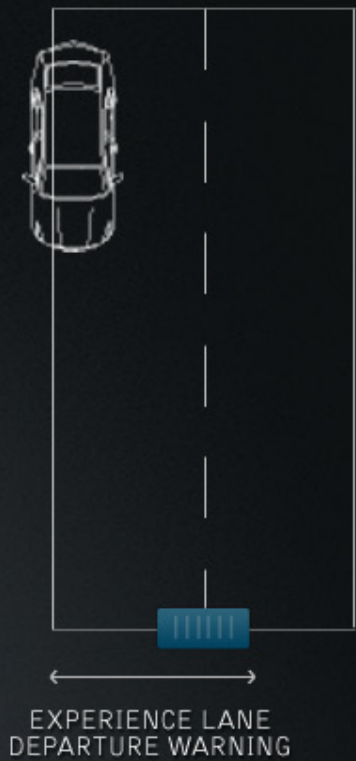



*IT'S AS DEFENSIVE*

*AS IT IS DYNAMIC.*

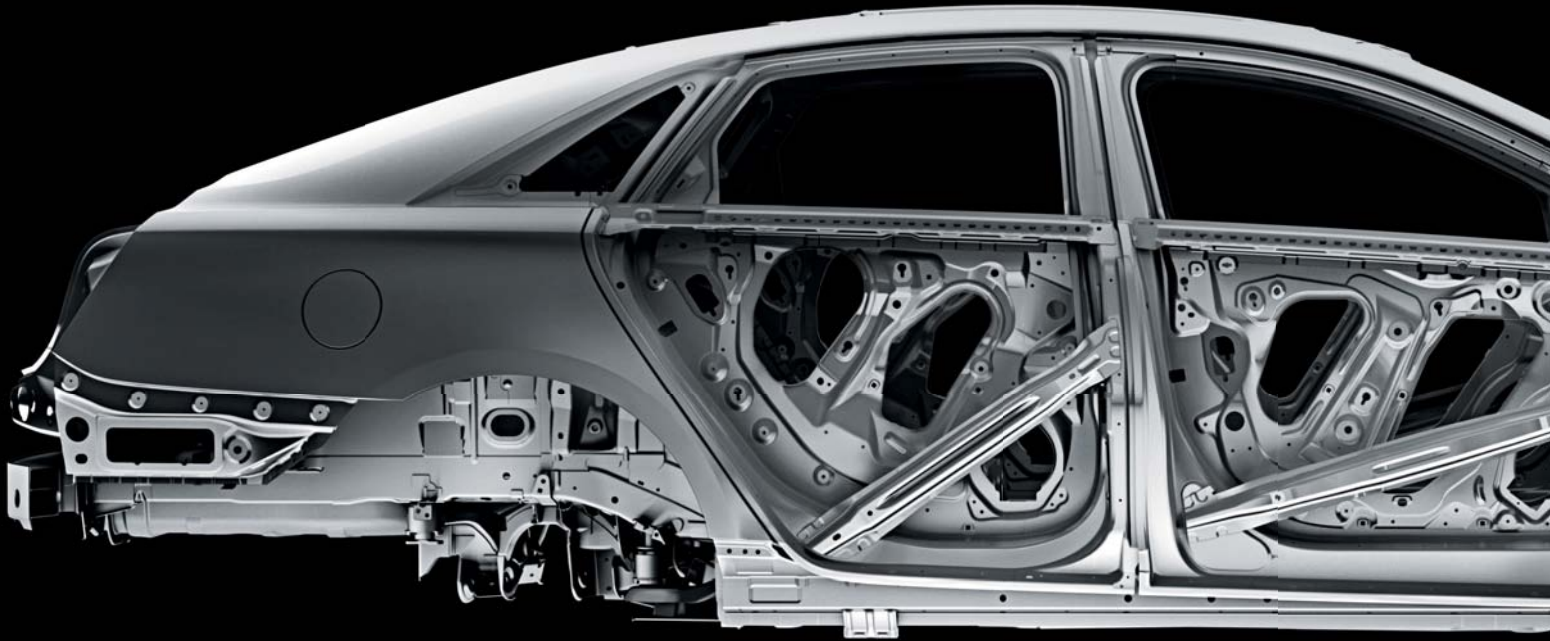

1. Late availability. 2. Always use safety belts and the correct restraint for your child's age and size. Even in vehicles equipped with the Passenger Sensing System, children are safer when properly secured in a rear seat in the appropriate infant, child or booster seat. Never place a rear-facing infant restraint in the front seat of any vehicle equipped with a passenger air bag. See the Owner's Manual and child safety seat instructions for more safety information. 3. Visit [onstar.com](http://onstar.com) for details and system limitations. OnStar acts as a link to existing emergency service providers.

### **SENSOR FUSION**

By seamlessly integrating available sensor and positioning technologies, Sensor Fusion<sup>1</sup> is an integral building block toward the development of fully autonomous vehicles. And it's being used today in the all-new XTS.

### **AUTOMATIC FRONT AND REAR BRAKING**

Most avoidable collisions happen at low speeds. That's why radar and ultrasonic sensors in the front and rear are always on the lookout. This available technology may even help you prevent a collision by activating the brakes automatically.

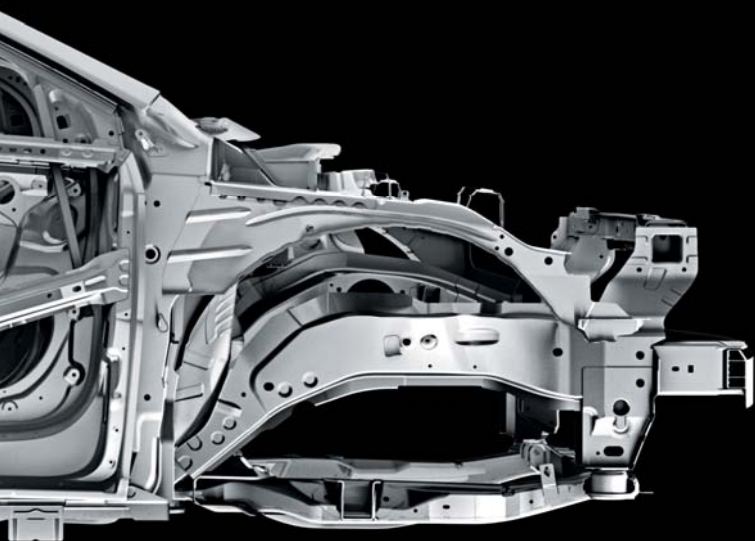

It starts with a protective safety cage constructed with high-strength steel alloys for exceptional rigidity and strategically placed crumple zones. Then we add preventive safety features like the StabiliTrak Electronic Stability Control System and a sophisticated antilock braking system (ABS) with Electronic Braking Force Distribution that helps balance stopping power between the front and rear brakes. There's also the confidence that comes with ten standard airbags<sup>2</sup> and a standard one-year subscription to OnStar<sup>3</sup> Automatic Crash Response. In a crash, built-in sensors in your vehicle can automatically send an alert to an OnStar Advisor, who can contact you in your car.



*XTS PLATINUM COLLECTION / Graphite Metallic*

Push the start button, and the V6 comes to life with a muscular rumble. But it's what goes on under the artfully sculpted hood that is truly impressive. Designed to complement the exceptional handling of the XTS, the 304 HP 3.6L V6 engine is an advanced study in technology. Spray-guided direct fuel injection delivers fuel precisely to the center

of the combustion chamber. Along with Variable Valve Timing, this maximizes the air/fuel ratio for optimal power and efficiency.<sup>1</sup> The engine is coupled with an advanced Gen-II automatic transmission that delivers crisp, smooth shifts in step with the V6 engine's impressive output. When you call for power, the XTS answers immediately.

1. EPA-estimated mpg 17 city / 28 highway, FWD. 17 city / 26 highway, AWD.



IT'S A RARE ENGINE THAT  
APPEALS TO YOUR LEFT BRAIN  
AND RIGHT FOOT  
IN EQUAL MEASURES.



#### **3.6L DIRECT-INJECTION V6 ENGINE**

Known for its smooth, seamless power delivery, this standard 3.6L direct-injection V6 engine is also remarkably fuel efficient.<sup>1</sup>



#### **DRIVER SHIFT CONTROL**

The electronically controlled 6-speed automatic transmission incorporates steering wheel-mounted paddle shifters that enable clutchless manual shifting. A quick tap is all that's required for a smooth, crisp upshift or downshift.

*THE ROAD MEANDERS.*

# *THE XTS DOES NOT.*

Any luxury sedan can hold its own on a long stretch of interstate. However, when the pavement twists, writhes and dips, the XTS quickly separates itself from everything else on the road. With its advanced suspension and precisely tuned steering, it delivers a perfectly connected and sophisticated ride. Torque-vectoring All-Wheel Drive is available and features advanced software that manages torque front-to-rear, while the rear electronic Limited-Slip Differential (eLSD) controls torque side-to-side along the rear axle, putting power where you need it most for a surefooted grip on the pavement. The XTS also features revolutionary dual-mode Magnetic Ride Control that reacts in the blink of an eye to changing demands, while its advanced HiPer Strut technology helps the tires remain keyed to the surface. Combined with rear auto load-leveling suspension and speed-sensitive steering, the XTS handling is nothing short of a revelation.

***SEE HOW THE POWER OF MAGNETS GIVES  
XTS A FLAWLESS RIDE.***

Watch Video [»](#)

**MAGNETS**  
Revolu  
Ride Co  
to 1,000  
seamles  
agile ha

*THE ROAD MEANDERS.*

# *THE XTS DOES NOT.*

Any luxury sedan can hold its own on a long stretch of interstate. However, when the pavement twists, writhes and dips, the XTS quickly separates itself from everything else on the road. With its advanced suspension and precisely tuned steering, it delivers a perfectly connected and sophisticated ride. Torque-vectoring All-Wheel Drive is available and features advanced software that manages torque front-to-rear, while the rear electronic Limited-Slip Differential (eLSD) controls torque side-to-side along the rear axle, putting power where you need it most for a surefooted grip on the pavement. The XTS also features revolutionary dual-mode Magnetic Ride Control that reacts in the blink of an eye to changing demands, while its advanced HiPer Strut technology helps the tires remain keyed to the surface. Combined with rear auto load-leveling suspension and speed-sensitive steering, the XTS handling is nothing short of a revelation.

***SEE HOW THE POWER OF MAGNETS GIVES  
XTS A FLAWLESS RIDE.***

**MAGNETIC**  
Revolu  
Ride Co  
to 1,000  
seamles  
agile ha



## *METIC RIDE CONTROL*

ionary dual-mode Magnetic  
ontrol reads the road up  
0 times per second and  
ssly adjusts damping for  
andling and a controlled ride.

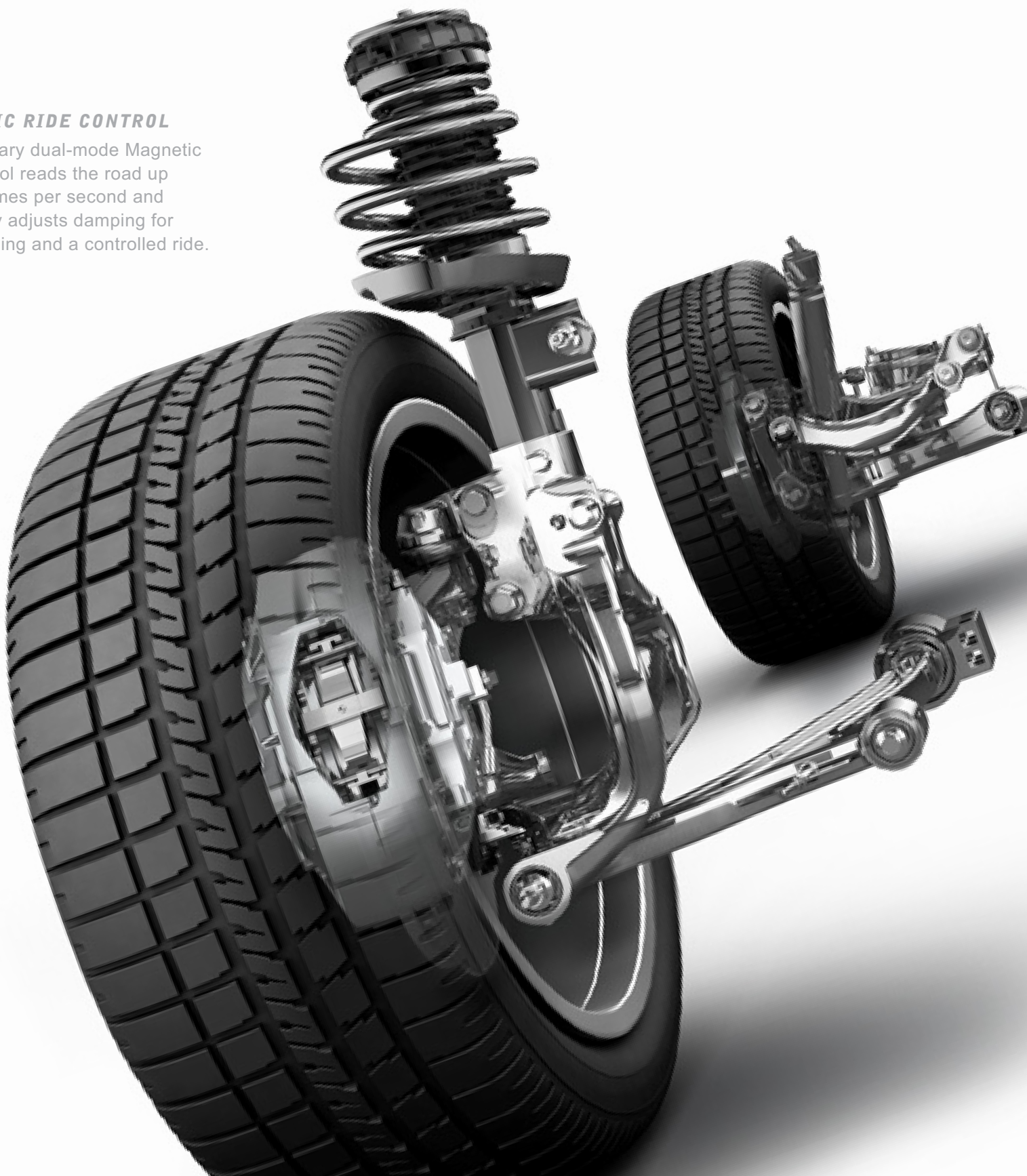

*THE PLATINUM COLLECTION*



*XTS PLATINUM COLLECTION / Graphite Metallic*





XTS

EXTERIOR

LIGHTING

INTERIOR

CUE

SAFETY TECHNOLOGY

PERFORMANCE

COLLECTIONS

COLOR

WHEELS & SPECS



THE PLATINUM COLLECTION



XTS PLATINUM COLLECTION / Jet Black with Light Wheat accents





XTS

EXTERIOR

LIGHTING

INTERIOR

CUE

SAFETY TECHNOLOGY

PERFORMANCE

COLLECTIONS

COLOR

WHEELS & SPECS

*THE PLATINUM COLLECTION:*

*WE DON'T PLAY GAMES*

*WHEN IT COMES TO LUXURY.*

*UNLESS, OF COURSE, IT'S LEAPFROG.*



**ULTRAVIEW SUNROOF**

The power-retractable sunroof spans both rows of seats, giving the XTS an even more spacious feel.



**LEATHER-WRAPPED INTERIOR**

Leather wraps virtually every surface you touch and feel in the XTS, enhancing the experience before you even start the engine.

1. Jet Black with Light Wheat accents interior only. 2. Adaptive Cruise Control is no substitute for the driver's personal responsibility to operate the vehicle in a safe manner. The driver needs to remain attentive to traffic and road conditions and provide the steering, braking or other inputs necessary to retain control of the vehicle. 3. Late availability.



The XTS Platinum Collection takes all the innovation, design and especially the luxury of the XTS to an even higher level. Leather envelops the instrument panel and floor console, and even flows onto the door. Opus full-leather seats are not only exceptionally supple, but so meticulously detailed that even the inside edges of their cooling perforations reveal a subtle hint of contrasting<sup>1</sup> color. The Lineate wood is exclusive to Platinum, and so richly grained, it takes on extra dimension. While overhead, a microfiber-sueded headliner surrounds an UltraView sunroof that opens to the heavens above.

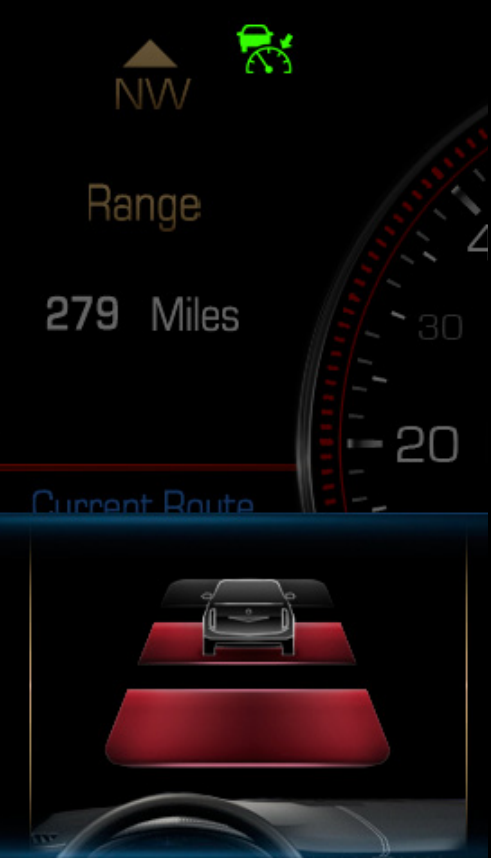

### **ADAPTIVE CRUISE CONTROL**

Progressive technology in the XTS affords an assured and comfortable journey with available Adaptive Cruise Control<sup>2,3</sup> as well as Automatic Front and Rear Braking.<sup>3</sup>



### **EXCLUSIVE GRILLE**

The strong lines and refined mesh combine to make a statement that is found only on the Platinum Collection.



*THE PREMIUM COLLECTION*

*XTS PREMIUM COLLECTION / Sapphire Blue Metallic*







THE PREMIUM COLLECTION



XTS PREMIUM COLLECTION / Caramel with Jet Black accents





XTS

EXTERIOR

LIGHTING

INTERIOR

CUE

SAFETY TECHNOLOGY

PERFORMANCE

COLLECTIONS

COLOR

WHEELS & SPECS

*THE PREMIUM COLLECTION:*

*PREDICTIONS SEEM FRIVOLOUS WHEN YOU'VE ALREADY  
SEEN THE FUTURE.*



### **HEAD-UP DISPLAY**

Using head-up display technology similar to that found in fighter jets, this feature helps keep your eyes on the road by projecting customizable key driving and entertainment information in full color at eye level.



### **ADAPTIVE FORWARD LIGHTING**

With Adaptive Forward Lighting, sensors read your speed and steering angle, swiveling the High-Intensity Discharge (HID) headlamps up to 15 degrees to illuminate the direction of travel.

1. Map coverage available in the United States, U.S. Virgin Islands, Puerto Rico and Canada.

2. Requires active SiriusXM subscription.



It's as close as you can get to a personalized fit. Tri-zone climate control means every inch of the car is perfectly heated or cooled. The reconfigurable gauge cluster allows you to find the layout of information that perfectly suits you. The richly designed interior comes complete with a 14-speaker Bose Studio Surround sound system. Even a navigation system<sup>1</sup> with map-integrated Doppler weather<sup>2</sup> reports is just another example of how we've pushed refinement to a whole new level.



### **BOSE STUDIO SURROUND SOUND SYSTEM**

Your XTS doubles as an intimate concert venue with the 14-speaker Bose Studio Surround sound system that includes two Personal surround speakers on the top of each front seat.



### **NAVIGATION SYSTEM**

Connectivity is within easy reach, thanks to the navigation system.<sup>1</sup> Featuring easy, intuitive voice guidance, 3-D GPS color imaging with integrated Doppler weather<sup>2</sup> and more, it's your on-the-road control center.

*THE LUXURY COLLECTION*



*XTS LUXURY COLLECTION / Silver Coast Metallic*





XTS

EXTERIOR

LIGHTING

INTERIOR

CUE

SAFETY TECHNOLOGY

PERFORMANCE

COLLECTIONS

COLOR

WHEELS & SPECS



THE LUXURY COLLECTION



XTS LUXURY COLLECTION / Shale with Cocoa accents





XTS

EXTERIOR

LIGHTING

INTERIOR

CUE

SAFETY TECHNOLOGY

PERFORMANCE

COLLECTIONS

COLOR

WHEELS & SPECS

*THE LUXURY COLLECTION:*

*HOW CLOSE DID WE COME TO THE ONE IN  
YOUR IMAGINATION?*



***PREMIUM WOOD TRIM***

Eye-catching wood sets the tone for the interior of the XTS with its deep, rich color. The beautiful grain appears to change with the lighting, adding an extra touch of allure.



***INTEGRATED EXHAUST***

The dual-exhaust outlets are integrated into the rear fascia to ensure the impeccable lines of the XTS remain unbroken.



Step inside, and you'll find premium wood accents highlighting the instrument panel, door and shifter. With a Memory Package for two drivers that recalls presets for the power driver seat, outside mirrors and the steering column, the XTS stands ready no matter who holds the key. Heated, ventilated front seats with cushion-length adjusters and heated outboard rear seats mean everybody in the cabin is comfortable, no matter how long the drive or the temperature outside. Of course, it's all complemented by dramatic ambient lighting. Even the dual-exhaust outlets are beautifully integrated into the fascia to complete the modern and refined look. Proof that luxury and advanced design can coexist in perfect harmony.



### ***VENTILATED FRONT SEATS***

Air-cooled front seats with cushion-length adjusters are a welcome rejuvenation on hot days and during extended journeys.



### ***HEATED STEERING WHEEL***

The perfect antidote to a cold winter morning.

# CUSTOMIZE YOUR XTS EXTERIOR

[BUILD YOUR OWN >>](#)

[LOCATE A DEALER >>](#)



RADIANT SILVER  
METALLIC

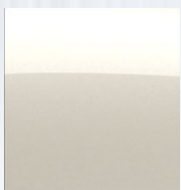

WHITE DIAMOND  
TRICOAT<sup>1</sup>

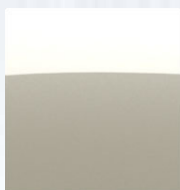

SILVER COAST  
METALLIC<sup>2</sup>



CRYSTAL RED  
TINTCOAT<sup>1</sup>

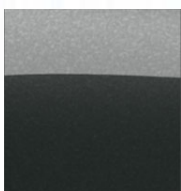

GRAPHITE  
METALLIC

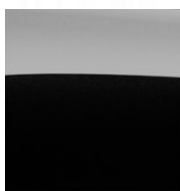

BLACK RAVEN

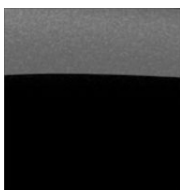

BLACK DIAMOND  
TRICOAT<sup>1</sup>

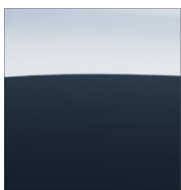

SAPPHIRE BLUE  
METALLIC



1. Available at extra cost. 2. Not available with Medium Titanium with Jet Black accents interior.





#### *P A I N T   F I N I S H E S*

##### ***T I N T C O A T***

A premium 2-layer paint application with the addition of a tinted clearcoat, lending the finish an extra depth and brightness.

##### ***T R I C O A T***

A meticulous 3-layer process that results in a dramatic hue-shifting color.

# XTS INTERIOR CHOICES

BUILD YOUR OWN »

LOCATE A DEALER »



*XTS in Jet Black<sup>1</sup>*



*XTS Luxury Collection in Shale*



*XTS Premium Collection in Medium Titanium  
with Jet Black accents.<sup>4</sup>*



*XTS Platinum Collection in  
Light Wheat accents*

1. Jet Black available on XTS, XTS Luxury and XTS Premium Collections.
2. Shale with Cocoa accents available on XTS, XTS Luxury and XTS Premium Collections.
3. Caramel with Jet Black accents available on XTS Luxury and XTS Premium Collections.
4. Medium Titanium with Jet Black accents available on XTS Luxury and XTS Premium Collections.
5. XTS Platinum Collection only.





*with Cocoa accents.<sup>2</sup>*



*XTS Premium Collection in Caramel with  
Jet Black accents.<sup>3</sup>*



*in Jet Black with  
Dark Urban and Cocoa accents.<sup>5</sup>*



*XTS Platinum Collection in Light Platinum with  
Dark Urban and Cocoa accents.<sup>5</sup>*





## ***THE STANDARD OF THE WORLD AT YOUR FINGERTIPS***

We set out to create our own uniquely American breed of extraordinary. Each built with tenacity, a refusal to leave well enough alone. From dramatic designs to world-class performance, we're setting the standard. To stay current, we invite you to sign up for our monthly eNewsletter. You'll receive invitations to exclusive events, the latest product news and information and launch updates.

**SIGN UP »**

# XTS WHEEL CHOICES

[BUILD YOUR OWN >>](#)

[LOCATE A DEALER >>](#)

**20" CAST ALUMINUM  
WITH POLISHED FINISH  
AND CHROME INSERTS**

Platinum Collection, includes  
P245/40R20 all-season tires







61.7"

72.9"

111.7"

202.0"

59.1"

62.0"



**19" CAST ALUMINUM  
WITH POLISHED FINISH**

XTS Luxury and Premium  
Collections, includes  
P245/45R19 all-season tires



**19" CAST ALUMINUM WITH  
PREMIUM MULTI-COAT  
PAINTED FINISH AND  
CHROME INSERTS**

XTS, includes P245/45R19  
all-season tires



**20" CAST ALUMINUM WITH  
PREMIUM MULTI-COAT  
PAINTED FINISH**

Premium Collection option, includes  
P245/40R20 all-season tires

#### ABOUT THIS DIGITAL CATALOG

We have tried to make the information presented comprehensive and factual. We reserve the right, however, to make changes at any time, without notice, in prices, colors, materials, equipment, specifications, models and availability. Specifications, dimensions, measurements, ratings and other numbers presented here and in printed materials provided at the dealership or affixed to vehicles are approximates, based upon design and engineering drawings and prototypes and laboratory tests. Your vehicle may differ due to variations in manufacture and equipment. Since some information may have been recently updated; please check with your Cadillac dealer for complete details. Cadillac reserves the right to lengthen or shorten the model year for any product for any reason, or to start and end model years at different times. Note: Some photographs show vehicles with optional equipment.

**ONSTAR** OnStar services require vehicle electrical system (including battery), wireless service and GPS satellite signals to be available and operating for features to function properly. OnStar acts as a link to existing emergency service providers. Subscription Service Agreement required. Call 1-888-4ONSTAR (466-7827) or visit [onstar.com](http://onstar.com) for OnStar's Terms and Conditions, Privacy Policy and details and system limitations.

**ENGINES** Cadillac products are equipped with engines produced by GM Powertrain or suppliers to GM worldwide. The engines in Cadillac products may also be used in other GM makes or models.

#### TIRE SEALANT AND COMPRESSOR KIT

Unless you option into a spare tire, there is no jack or spare tire in this vehicle. If you do not option into the spare tire, your vehicle has a tire sealant and compressor kit that uses a liquid tire sealant to temporarily seal up to a 1/4-inch puncture in the tread area of the tire. After using the inflator kit, it is recommended to take the tire to an authorized dealer for inspection and repair as soon as possible but at least within 100 miles of driving. The tire sealant cannot seal and inflate sidewall damage, punctures larger than 1/4 inch, or a tire that has unseated from the wheel. The sealant can only be used on one tire one time before its expiration date.

**ASSEMBLY** Cadillac vehicles and their components are assembled or produced by different operating units of General Motors, its subsidiaries or suppliers to GM worldwide. We sometimes find it necessary to produce Cadillac vehicles with different or differently sourced components than originally scheduled. Since some options may be unavailable when your vehicle is assembled, we suggest that you verify that your vehicle includes the equipment you ordered or, if there are changes, that they are acceptable to you.

#### UPDATED SERVICE INFORMATION

Cadillac dealers receive useful service bulletins about Cadillac products. You may purchase them from Helm Incorporated by calling 1-800-551-4123 or by visiting [www.helminc.com](http://www.helminc.com).



## NEW-VEHICLE LIMITED WARRANTY

World-class coverage comes standard on every 2013 Cadillac. This warranty is for Cadillac vehicles registered in the U.S.A. See your Cadillac dealer for terms and conditions.

### COVERED FOR 6 YEARS/70,000 MILES (WHICHEVER COMES FIRST)

Powertrain Limited Warranty with no deductible, Roadside Assistance Program,<sup>1</sup> Courtesy Transportation Program.<sup>1</sup>

### COVERED FOR 4 YEARS/50,000 MILES (WHICHEVER COMES FIRST)

Bumper-to-Bumper coverage; Tires – Defects in material and workmanship; Repairs made to correct any vehicle defect; Corrosion on body sheet metal panels.

**RUST THROUGH PROTECTION** Cadillac vehicles are designed and built to resist corrosion and rust-through corrosion. Any body sheet metal that rusts through (in the form of an actual hole in the sheet metal) is covered for six years unlimited mileage. Cosmetic or surface corrosion, resulting from stone chips or scratches in the paint, for example, is not included in the Rust Through coverage. Application of additional rust-inhibiting materials is not required under the Rust Through coverage and none is recommended. See your Cadillac dealer for terms of this limited warranty.

**FLEET ORDERS** Some standard content may be deleted with fleet orders. See dealer for details.

## AN IMPORTANT NOTE ABOUT ALTERATIONS AND WARRANTIES

Installations or alterations to the original equipment vehicle (or chassis) as distributed by General Motors are not covered by the General Motors New-Vehicle Limited Warranty. The special body company, assembler, equipment installer or upfitter is solely responsible for warranties on the body or equipment and any alterations (or any effect of the alterations) to any of the parts, components, systems or assemblies installed by GM. General Motors is not responsible for the safety or quality of design features, material or workmanship of any alterations by such suppliers.

1. Roadside Assistance Program and Courtesy Transportation Program are not a part of the New Vehicle Limited Warranty. A separate booklet entitled "Warranty and Owner Assistance Information" furnished with each new vehicle provides detailed warranty coverage information.

GM, the GM emblem, Cadillac, the Cadillac badge, OnStar, the OnStar emblem and the slogans, emblems, vehicle model names, vehicle body designs and other marks appearing in this catalog are the trademarks and/or service marks of General Motors, its subsidiaries, affiliates or licensors. iPod is a registered trademark of Apple, Inc.

©2012 General Motors. All rights reserved.