

F-TYPE







F-TYPE

It had to be powerful, agile and utterly distinctive. It had to look, feel and drive like a Jaguar. A true Jaguar sports car; the latest in a distinguished bloodline. We couldn't just call it F-TYPE; we had to make it F-TYPE.

The F-TYPE is engineered for high performance and instantaneously responsive handling: powerful, supercharged engines and a lightning-fast gearbox; lightweight aluminum body construction and an obsession with balance and proportion; a superb suspension and a host of advanced driving technologies; peerless design and a driver focused cockpit. Together they produce a uniquely connected driving experience, and a sports car that only Jaguar could create - ultra-precise, powerful, sensual and, most of all, alive.

VEHICLE SHOWN ON FRONT COVER AND LEFT: F-TYPE V8 S IN SALSA RED
VEHICLE SHOWN ON BACK COVER: F-TYPE IN STRATUS GREY



PURE DRIVING PLEASURE

The technical excellence of the F-TYPE delivers a breadth of capabilities to suit the road, the conditions and the demands of the driver.



VEHICLES SHOWN: F-TYPE IN STRATUS GREY



THREE DIFFERENT LIVES

There are three models, each equally at home on the switchback of a mountain pass, on the highway and in the city, while each offering its own distinctive flavor and characteristics.

F-TYPE is designed to deliver pure driving pleasure. It combines effortless, exhilarating performance, instant response and precise agile handling, with everyday refinement and usability.

F-TYPE S adds greater power and an increased range of sophisticated performance technologies.

F-TYPE V8 S offers towering performance and even greater levels of dynamic ability and control.



F-TYPE

- 3.0L V6 340 HP Supercharged
- Jaguar Performance Braking System
- Sport Suspension
- Sport Exhaust
- 18-inch alloy wheels

VEHICLE SHOWN: F-TYPE IN STRATUS GREY



F-TYPE S

- 3.0L V6 380 HP Supercharged
- Jaguar High Performance Braking System
- Sport Suspension with Adaptive Dynamics
- Active Sport Exhaust
- Limited Slip Differential
- Dynamic Mode
- 19-inch alloy wheels

VEHICLE SHOWN: F-TYPE S IN SATELLITE GREY

F-TYPE V8 S

- 5.0L V8 495 HP Supercharged
- Jaguar Super Performance Braking System
- Sport Suspension with Adaptive Dynamics
- Active Sport Exhaust
- Electronic Active Differential
- Quad Exhaust Pipes
- Dynamic Mode
- 20-inch alloy wheels

VEHICLE SHOWN: F-TYPE V8 S IN SALSA RED





SUPERCHARGED ENGINES

Power is delivered from a range of three highly advanced engines: a 3.0L V6 with 340 HP, a 3.0L V6 with 380 HP and a 5.0L V8 with 495 HP. Each features a Roots-type twin vortex supercharger mounted in the 'V' of the engine to maintain the powerplants' compact dimensions.

Jaguar is a leader in the field of **Supercharged induction technology**. The advantages of supercharging are clear and compelling: it provides a linear delivery of performance and instant access to high levels of torque at all engine speeds, minimizing the gap between the driver's demand for power and the engine's response.

The **F-TYPE Sport Exhaust** delivers a crisp note from start up with the promise of performance, building to a race-car inspired crescendo at high rpm and during overrun. An **Active Sport Exhaust** is standard on the **F-TYPE S** and **F-TYPE V8 S** and is also optional on the **F-TYPE**. The system features active bypass valves which open during performance driving to allow exhaust gases to exit more directly for a deep, dramatic sound. An optional **Switchable Active Exhaust** allows manual control of the system for even greater driver involvement.



V6

3.0 LITER 340 HP

3.0 LITER 380 HP

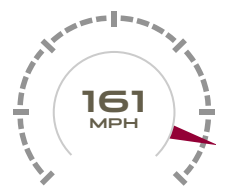

0-60 MPH¹

TOP SPEED MPH¹

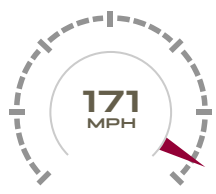

0-60 MPH¹

TOP SPEED MPH¹

Jaguar's new generation of supercharged 3.0 liter V6 engines are powerful and refined. Generating extremely high specific power outputs of up to 127 HP per liter, they deliver thrilling performance and a rewarding driving experience. The compact supercharger's sophisticated boost control and secondary throttle valve ensure that torque curves rise steeply over a broad range of engine speeds. A water-cooled intercooler reduces the temperature of the intake air for greater power and efficiency, while an innovative system of counter-rotating front and rear balancer weights aids smoothness and refinement. They also feature a fast-reacting **Intelligent Stop/Start** system that can improve fuel economy by up to 5 percent.





V8

5.0 LITER 495 HP



0-60 MPH¹

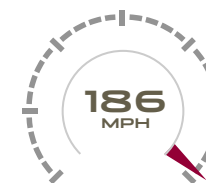

TOP SPEED MPH¹



The 495 HP 5.0 liter V8 is supremely powerful. A larger supercharger feeds the engine to deliver an astonishing peak torque of 460 lb.ft. from just 2,500 rpm. Acceleration is rapid and progressive, response is immediate and predictable. Advanced technologies deliver performance, refinement and efficiency. The lightweight die-cast aluminum block is supplemented by cross-bolted main bearing caps to increase rigidity. Valves are controlled by dual independent variable cam timing to optimize power at all engine speeds. Spray-guided direct injection delivers precisely measured quantities of fuel directly into the center of the combustion chambers at pressures of up to 2,175 psi for cleaner, more efficient combustion. In common with the V6 engines, it also features an **Intelligent Stop/Start** system that can improve fuel economy by up to 5 percent.

MODELS

STANDARD FEATURES

- QuickShift 8-speed automatic transmission with SportShift selector and steering wheel mounted one touch paddles
- Dynamic Stability Control (DSC) with TracDSC mode²
- Intelligent Stop/Start system
- Electric Parking Brake (EPB) – drive-away release
- Deployable rear spoiler
- Deployable door handles
- Bi-function HID xenon headlamps with washers and LED signature lights
- LED tail lamps
- Electronically operated convertible roof
- Jaguar Smart Key System™ with Keyless start
- Instrument cluster – Twin dials with 5-inch color TFT display
- 8-inch color Touch-screen display
- Navigation system³
- 380-Watt Meridian™ audio system with 10 speakers
- ISB/iPod® audio port and Auxiliary socket
- Roll Over Protection Bars²
- Bluetooth® phone and audio connectivity³



F-TYPE

ENGINE 3.0 Liter V6 340 HP Supercharged

ACCELERATION 0-60mph 5.1 seconds¹

TOP SPEED 161mph¹

- Jaguar Performance Braking System with Silver calipers
- Sport suspension
- Sport Exhaust
- Center mounted twin exhaust pipes
- 18-inch Vela alloy wheels
- Sport seats with leather and Suedecloth facings
- 3-spoke leather steering wheel with Black gear shift paddles
- Light Hex Aluminum console trim

 Configure your car at JAGUARUSA.COM/F-TYPE



F-TYPE S

ENGINE 3.0 Liter V6 380 HP Supercharged

ACCELERATION 0-60mph 4.8 seconds¹

TOP SPEED 171mph¹

- Jaguar High Performance Braking System with Black calipers
- Sport suspension with Adaptive Dynamics
- Active Sport Exhaust
- Center mounted twin exhaust pipes
- 19-inch Propeller alloy wheels
- Dynamic Mode
- Limited Slip Differential
- Sport seats with leather and Suedecloth facings
- 3-spoke leather steering wheel with Ignis gear shift paddles
- Dark Hex Aluminum console trim with 'S' graphic
- Configurable Ambient Interior Lighting with selectable palette
- Jaguar Smart Key System™ with keyless entry

F-TYPE V8 S

ENGINE 5.0 Liter V8 495 HP Supercharged

ACCELERATION 0-60mph 4.2 seconds¹

TOP SPEED 186mph¹

- Jaguar Super Performance Braking System with Black calipers
- Sport suspension with Adaptive Dynamics
- Active Sport Exhaust
- Quad exhaust pipes
- 20-inch Cyclone Silver alloy wheels
- Dynamic Mode
- Electronic Active Differential
- Sport seats with leather facings, 14-way electrically adjustable
- 3-spoke leather steering wheel with Ignis gear shift paddles
- Dark Hex Aluminum console trim with 'S' graphic
- Configurable Ambient Interior Lighting with selectable palette
- Jaguar Smart Key System™ with keyless entry
- Reverse Parking Sensors
- Dual Zone Climate Control



QUICKSHIFT TRANSMISSION



8-SPEED
RATIOS

ADAPTIVE
SOFTWARE

INSTANTANEOUS
RESPONSE

The F-TYPE QuickShift transmission is both exceptionally fast and superbly refined, offering the benefits of both a double clutch transmission and a conventional automatic without the limitations of either. Eight closely-spaced ratios keep the engine within its most effective rev range for longer, providing instantaneous response and outstanding driver feedback, while also optimizing the engine for both economy and outright performance.

The transmission control system is intelligent and adaptive. It monitors the driving situation together with the demands the driver is making on the car, and responds to provide a truly dynamic experience. Adaptive software automatically modifies the gear shift strategy, ensuring the right gear is selected for every situation. **Fast Throttle-Off** recognizes when the driver is making rapid throttle adjustments, for example during multiple maneuvers, and automatically holds the gear ratio in anticipation of the next move. **Corner Recognition** senses when the car is in a corner and holds the ratio ensuring the car is in the correct gear when exiting a bend. When decelerating and changing down, the **Speed Matching Management System** matches the engine speed to the gearbox speed, and automatically 'blips' the throttle during downshifts when in Sport mode, while **Spontaneous Vehicle Deceleration** enables the F-TYPE to rapidly downshift under very hard braking conditions.

Dynamic Launch Mode, standard on the **F-TYPE S**, applies maximum torque through the first two gear changes delivering optimum acceleration from rest to 60 mph.¹

The driver can, of course, take full manual control of the transmission using either gear shift paddles mounted behind the steering wheel, or the joystick-style SportShift gear selector. Once in manual mode, the Quickshift system delivers rapid and precisely timed engine torque interventions, creating shorter and crisper gear shifts.





LIGHTWEIGHT ALUMINUM CONSTRUCTION



STRONG AND RIGID

HIGH POWER-TO-WEIGHT AND TORQUE-TO-WEIGHT RATIOS

Jaguar has been at the forefront of aluminum car construction for more than a decade and continues to push the boundaries of the technology. The F-TYPE builds on this expertise and uses advanced techniques derived from the aerospace industry, such as epoxy bonding and riveting, to contribute towards the car's light, strong and rigid body structure.

A lightweight aluminum body structure with high torsional rigidity is the ideal platform for a convertible sports car, and is fundamental to the way the F-TYPE performs, handles and feels. A strong, stiff structure provides an inherently stable platform for precise, agile handling and allows the finely tuned suspension system to deliver connectivity and driver feedback. The body of the F-TYPE is the perfect complement to its high-performance engine range. Together they produce the exceptional power-to-weight and torque-to-weight ratios that deliver the real world measures of performance in a sports car.

All exterior panels are aluminum alloy with the exception of the trunk lid, which is made from composite materials, allowing hidden antennas to receive GPS and radio signals. The exterior panels are constructed from a new **AC600 alloy** that combines robustness and quality of finish with much greater formability for greater clarity and tightness of radiuses and feature lines. Jaguar has also developed a new **'warm forming'** technique for the inner door pressings which works like vacuum forming, using sheet metal rather than plastic. The use of advanced materials and innovative techniques allowed Jaguar's engineers to reproduce the beautifully crisp, crafted lines of the F-TYPE exactly as the designers had intended, as well as delivering a vehicle with extraordinary structural integrity.



ON BALANCE



OPTIMUM WEIGHT DISTRIBUTION

LOW CENTER OF GRAVITY

PERFECT PROPORTIONS

It is essential in the design of a great sports car that weight is kept to a minimum, is evenly distributed front to rear and that the center of gravity is kept as low as possible. This configuration in the F-TYPE means that the car has natural balance and is the result of meticulous attention to detail during the design and construction of the body structure. An uncompromising focus on weight distribution achieves the optimum balance between front and rear wheels, with items such as the battery, electronic systems and even the windshield washer fluid reservoir located at the rear of the car.

A shorter car is more agile; a wider car is more stable. The relationship between the length of 176 inches and width of 75.7 inches was precisely engineered to deliver inherent agility and means that the F-TYPE has outstanding driving dynamics. Its low center of gravity reduces body roll in corners, while short front and rear overhangs mean that the mass is concentrated within the wheelbase. These essential factors combine to ensure that the F-TYPE is naturally agile.

MOMENT OF MASS INERTIA

The closer the weight is to the center of the car, the easier it is to turn the car.

$$I = \sum_{i=1}^N m_i r_i^2$$

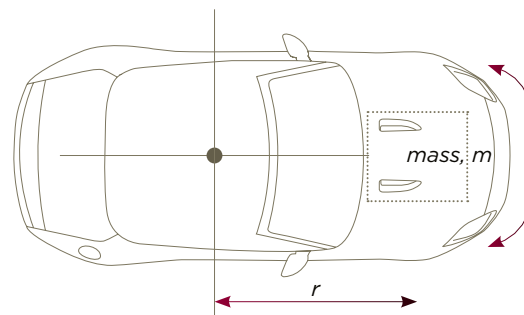

VEHICLE SHOWN: F-TYPE V8 S IN SALSA RED



NARDO RING TEST TRACK
ITALY

1729 acres of land with a 3.85 mile long handling circuit and a 7.8 mile long oval

HIGH-SPEED STABILITY TESTING



NÜRBURGRING NORDSCHLEIFE
GERMANY

Asphalt and concrete mixed surface. 12.93 miles long with 73 turns

HANDLING TESTING



PUT TO THE TEST

The F-TYPE first took to the road in the virtual world of Jaguar's Computer Aided Engineering (CAE) systems ensuring that all components underwent extensive development and testing before being committed to the physical testing process. Engineers produced a series of virtual prototypes to realistically simulate the behavior of complex mechanical systems allowing them to analyze multiple variations until the optimal design was achieved. For example, using a technique first used in the aerospace industry, aerodynamic testing took place in a virtual wind tunnel with Computational Fluid Dynamics running on high speed supercomputers. During its virtual life, the F-TYPE completed half a million tests, requiring 10 million computer processor hours and creating 300TB of data. The CAE development process was one of the key contributing factors in delivering the exhilarating performance and responsiveness of the F-TYPE.



DEATH VALLEY CALIFORNIA

Temperature up to 116.42°F

HOT CLIMATE
TESTING



COMPUTER AIDED
ENGINEERING

COMPUTATIONAL
FLUID DYNAMICS

10 MILLION
PROCESSOR HOURS

The real world testing to prove the car and fine tune the set-up took place in specialist facilities and the harshest environments across the globe in temperatures ranging from -40°F to 122°F, and at altitudes of up to 13,123ft. High-speed stability tests, for example, were conducted at the Nardo Ring in southern Italy. The Nordschleife circuit at the Nürburgring in Germany was the perfect location to prove out handling, braking, cooling and durability. Known as the “Green Hell”, and featuring 12.93 miles of track with 73 turns, it is renowned as the most demanding circuit in the world and the ultimate test of both car and driver.



STELVIO PASS, ITALY



BROUGHT TO LIFE

The essential ingredients in place, the F-TYPE is ready to take on the world's most thrilling roads. You'll discover an intuitive and instinctive driving experience like no other. An experience that surpasses high performance and pin sharp handling to deliver pure entertainment. The most awe-inspiring and exhilarating twists and turns on the road belong to the F-TYPE.





ACTIVE AERODYNAMICS

60MPH INITIATES AUTO DEPLOY | REDUCES LIFT BY UP TO **264LBS** | **40MPH** INITIATES AUTO RETRACT

Aerodynamic performance is the essence of the F-TYPE design and is seamlessly integrated into the body for low levels of lift and excellent stability at high speed. A front splitter beneath the grille and a rear venturi manage airflow along the vehicle's underside with the sharply defined tail helping air to separate cleanly at lower speeds. A deployable rear spoiler rises at speeds in excess of 60mph to **reduce lift by up to 264lbs**. Even the door handles retract when not required, with their flush design creating uninterrupted air flow along the flanks.





THE FASTEST CONNECTION BETWEEN DRIVER AND ROAD

The F-TYPE's quick, responsive steering is designed to provide the most direct connection between the driver's hands on the wheel and the contact point of the tires on the road. The car's quick steering rack delivers a precise reaction to driver input. The feeling of connection is also maximized by the use of aluminum alloy for the front subframe. This not only helps to reduce weight, but, in conjunction with the F-TYPE's forged alloy suspension, also creates an immensely strong structure for the most precise feedback and control.

VEHICLES SHOWN: F-TYPE V8 S IN SALSA RED





PERFORMANCE BRAKING SYSTEMS

Three braking systems are available, each engineered to deliver confident, progressive feel and sustained, consistent high performance. The front calipers make extensive use of aluminum to reduce the unsprung mass of the car, benefiting both handling and ride refinement. Each system features large, ventilated brake discs – up to 380mm (15 inches) in diameter on the High Performance and Super Performance systems. This large swept area improves braking force as well as providing greater capacity for the discs to absorb and dissipate the heat energy generated during braking.

Brake cooling is also enhanced with additional suspension scoops and ducts developed with the assistance of advanced Computational Fluid Dynamics systems. This channels cooling air directly to the brakes, reducing fade, and helping sustain their performance during extended periods of dynamic driving.

F-TYPE JAGUAR PERFORMANCE

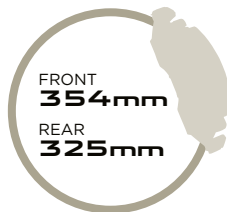

CALIPERS: SILVER (STANDARD)

F-TYPE S JAGUAR HIGH PERFORMANCE

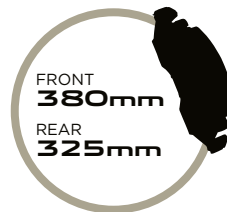

CALIPERS: BLACK (STANDARD)

F-TYPE V8 S JAGUAR SUPER PERFORMANCE*

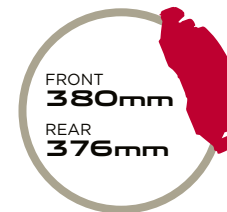

CALIPERS: BLACK (STANDARD)
RED (OPTIONAL)

*Jaguar Super Performance brakes with Red brake calipers are available as part of the Performance Pack on F-TYPE S and F-TYPE V8 S models





VEHICLES SHOWN: F-TYPE V8 S IN SALSA RED



CHASSIS AND SUSPENSION

The aluminum body of the F-TYPE creates an immensely stable platform from which the all-round forged aluminum double wishbone suspension can control the car. With the damping set-up optimized for the best partnership between dynamics and refinement, it gives the perfect combination of control, agility and feedback.

On the **F-TYPE S** and **F-TYPE V8 S** models, Adaptive Damping assesses body motion and pitch rates 100 times per second, and adjusts the settings for each damper accordingly. The system improves control, handling and agility as well as the ability to rapidly detect and react to critical driving conditions and driver demands. It achieves this with a series of sensors that are placed around the car to monitor the body's vertical movement, pitch and roll rates. The steering wheel position is measured 500 times per second enabling the system to predict the body's roll rate. The stiffness of each individual damper is then adjusted to help maintain body control, stability and agility.

MONITORS ROAD-INDUCED BODY MOTION **100 TIMES** PER SECOND

MONITORS STEERING WHEEL INPUT **500 TIMES** PER SECOND

PREDICTS PITCH FROM THROTTLE AND BRAKE INPUTS

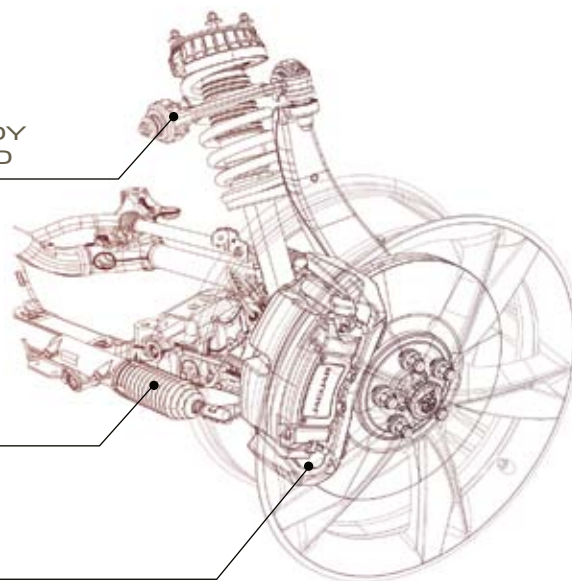

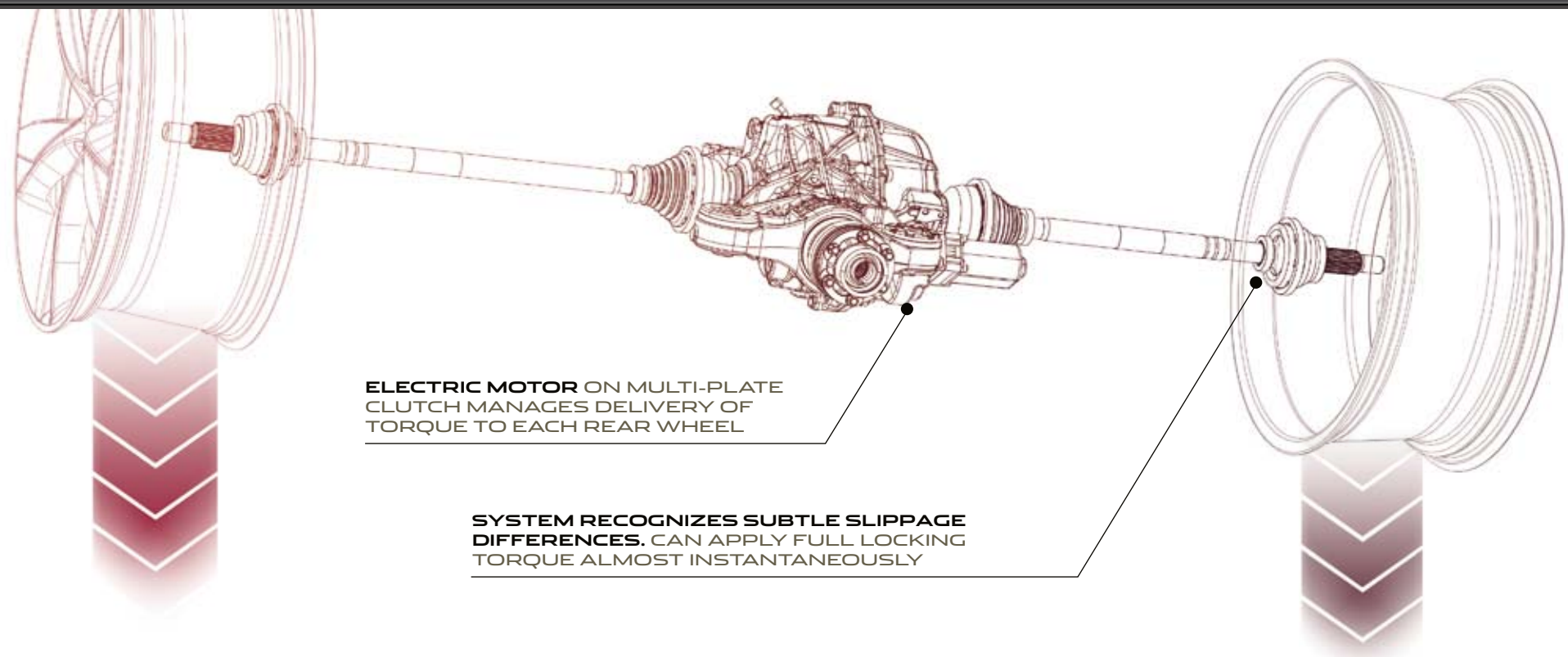

ELECTRIC MOTOR ON MULTI-PLATE CLUTCH MANAGES DELIVERY OF TORQUE TO EACH REAR WHEEL

SYSTEM RECOGNIZES SUBTLE SLIPPAGE DIFFERENCES. CAN APPLY FULL LOCKING TORQUE ALMOST INSTANTANEOUSLY

DIFFERENTIALS

The mechanical **Limited Slip Differential** featured in the **F-TYPE S** was chosen because of its innate suitability for the rear-wheel drive sports car experience. It offers the perfect opportunity to leverage the car's superb handling and the upper limits of its grip. The Limited Slip Differential improves traction and agility during acceleration out of corners and on slippery surfaces. The car can also make better use of the available traction before the DSC system needs to intervene and results in more refined stability control during dynamic driving.

An **Electronic Active Differential** provides the **F-TYPE V8 S** with the ultimate in agility and control. Working in conjunction with the stability, traction and ABS systems, the Electronic Active Differential uses an electric motor acting on a multi-plate clutch to manage the delivery of torque to each of the rear wheels. Full electronic control of the rear differential lock enables the system to apply full locking torque almost instantaneously. The Electronic Active Differential allows for very fine control of the power delivery to limit wheelspin, maximize traction and offers even greater levels of control.







ADVANCED CONTROL

The sophisticated transmission control system instinctively modifies the car's response to road conditions and driver input, enhancing the driving experience. It analyzes how the car is being driven by measuring acceleration and braking, cornering, as well as road load and kick down activation. It then uses sophisticated adaptive software to ensure that the most appropriate gear shift strategy is automatically selected. For even more responsive performance, the selection of Sport Mode alters the gear shift program to deliver shorter shifts and hold ratios at higher revs for longer.

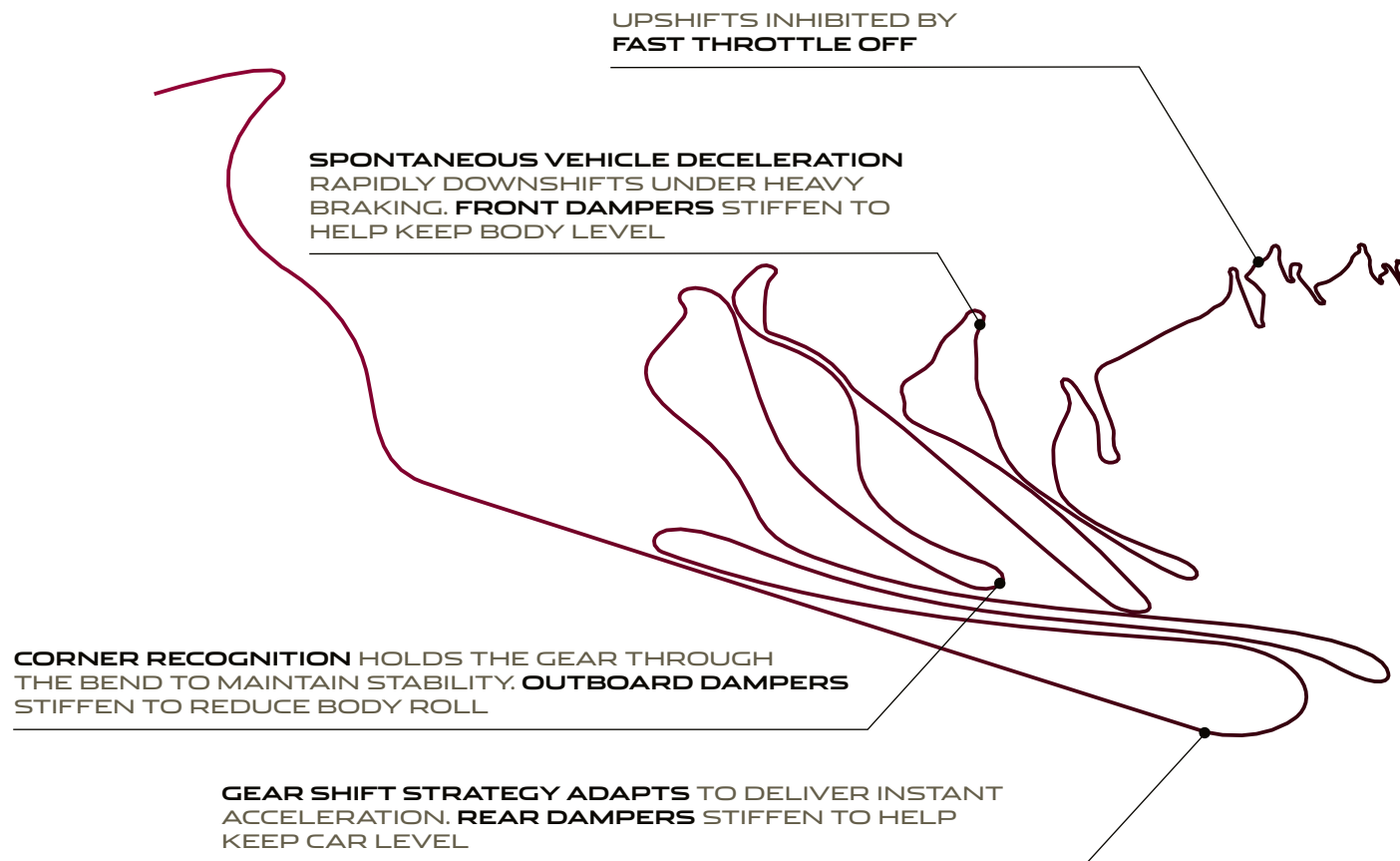



DYNAMIC MODE

SHARPENED THROTTLE RESPONSE | **QUICKER GEAR SHIFTS**

Dynamic Mode remaps the car's software to further emphasize its sporting character. It sharpens the throttle response, increases steering weighting and performs gear shifts more quickly and at higher engine speeds. Selecting Dynamic Mode also prevents automatic upshifts when the gearbox is used in manual mode. Dynamic Mode is standard on the **F-TYPE S** and **F-TYPE V8 S**.

On the **F-TYPE S** and **F-TYPE V8 S** models, the **Configurable Dynamics** part of the **Performance Pack** allows the driver to define which characteristics are altered when Dynamic Mode is selected. This option also features the **Dynamic-i** display system, which can show performance indices such as G-Force meter and lap time, plus throttle, steering and brake inputs on the 8-inch Touch-screen.



FOR MORE DEMANDING CONDITIONS, THE DRIVER CAN SELECT DYNAMIC MODE OR RAIN/ICE/SNOW MODE



ASSISTANCE AND REASSURANCE

BLIND SPOT MONITOR | **REVERSE TRAFFIC DETECTION** | **INTELLIGENT HIGH BEAM**

Sophisticated driver assistance systems are available as part of the optional Vision Pack to provide reassurance, information and control, and allow the driver to focus on the pleasure of the drive.² These include **Blind Spot Monitoring**, which is designed to help alert the driver to the presence of a vehicle in an adjacent lane. **Reverse Traffic Detection** can provide warnings of other vehicles in the reversing path of the F-TYPE, for example when backing out of a parking space. **Front and Rear Parking Aids** and a **Reverse Park Camera** also provide valuable assistance during parking maneuvers.

Standard **Bi-function HID xenon headlamps** provide an intense white light for both high and low beam in a single unit. The optional **Adaptive Front Lighting** system measures the speed of the car and angle of the steering wheel, swivelling the lamps by up to 14 degrees out, and up to 7 degrees in, for improved visibility during cornering. The optional **Intelligent High Beam** system automatically switches between low and high beam when necessary, using a sensor mounted at the front of the rear view mirror. The rear lamps feature LED technology with light guides that not only create a distinctive design, but also have the ability to illuminate to full brightness more quickly than conventional bulbs, potentially giving a following driver more time to react.

Every F-TYPE also features a complement of advanced active and passive safety systems, including **Emergency Brake Assist (EBA)**, **Electronic Brake-Force Distribution (EBD)**, driver and passenger front airbags, seat mounted side airbags with head protection, seat belt pre-tensioners and roll over protection bars.²

VEHICLE SHOWN: F-TYPE S IN SATELLITE GREY







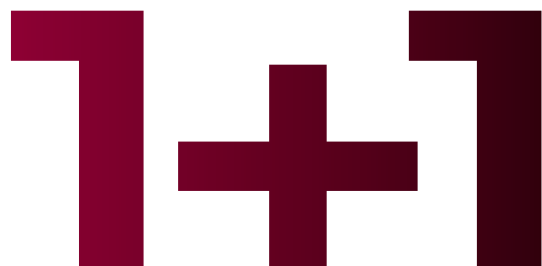

The F-TYPE immediately connects with the driver, so that he or she becomes almost an extension of the car. Its 1+1 configuration is designed to wrap around the driver. The cockpit's design provides visibility, minimal distractions and close-to-the-center-of-gravity seating with rigid seat frames and structure. The dash has been intentionally kept as low as possible and free from clutter to increase the forward view. The **Intelligent Venting System**, part of the advanced climate control system, hides the twin central air vents which automatically deploy when required, rising from the dashboard and retracting after use. Two seat styles are available, the standard **Sport Seat**, and an optional **Performance Seat**, offering enhanced lateral support during rapid cornering and upholstered in Premium leather. For an even more luxurious finish, all models can also be specified with the optional **Extended Leather Pack**, which adds leather to the upper dash, center console, door casings, windshield pillars, sunvisors and header rail. The Extended Leather Pack also makes available additional striking interior combinations, including contrast stitching and duo-tone interiors.



DRIVER ORIENTATED CONTROLS

The F-TYPE presents information to the driver only as necessary or when requested. Instruments are simple, clear and easy to read featuring two large analog dials – essential in a sports car. The three spoke design of the steering wheel incorporates key functions, with gearshift paddles mounted behind the spokes for manual control without the need for the driver's hands to be taken from the wheel.

The **Jaguar SportShift Selector** is simple and intuitive to use, inviting greater driver involvement: it offers full Auto mode plus, in Sport Mode, manual operation. This allows the driver to select gears sequentially by tipping the lever forward to shift down a ratio and shift up a gear by pulling the lever back.

Dual Mode Rotary Switches are used as part of the controls for the advanced climate control system. Right and left dials control cockpit temperature on the respective sides of the car when dual zone climate control is specified. When pressed, the dials change mode to control the optional seat heating functions, with the screen at the center of the dial changing to display the corresponding use.

The F-TYPE's **8-inch color Touch-screen** provides simple control of a number of the car's features, including Navigation, Infotainment and, when fitted with the Performance Pack, the F-TYPE's Dynamic-i display system.³



INTERIORS SHOWN: F-TYPE S WITH SPORT SEATS IN JET PREMIUM LEATHER WITH EXTENDED LEATHER PACK

THE FEELING INSIDE



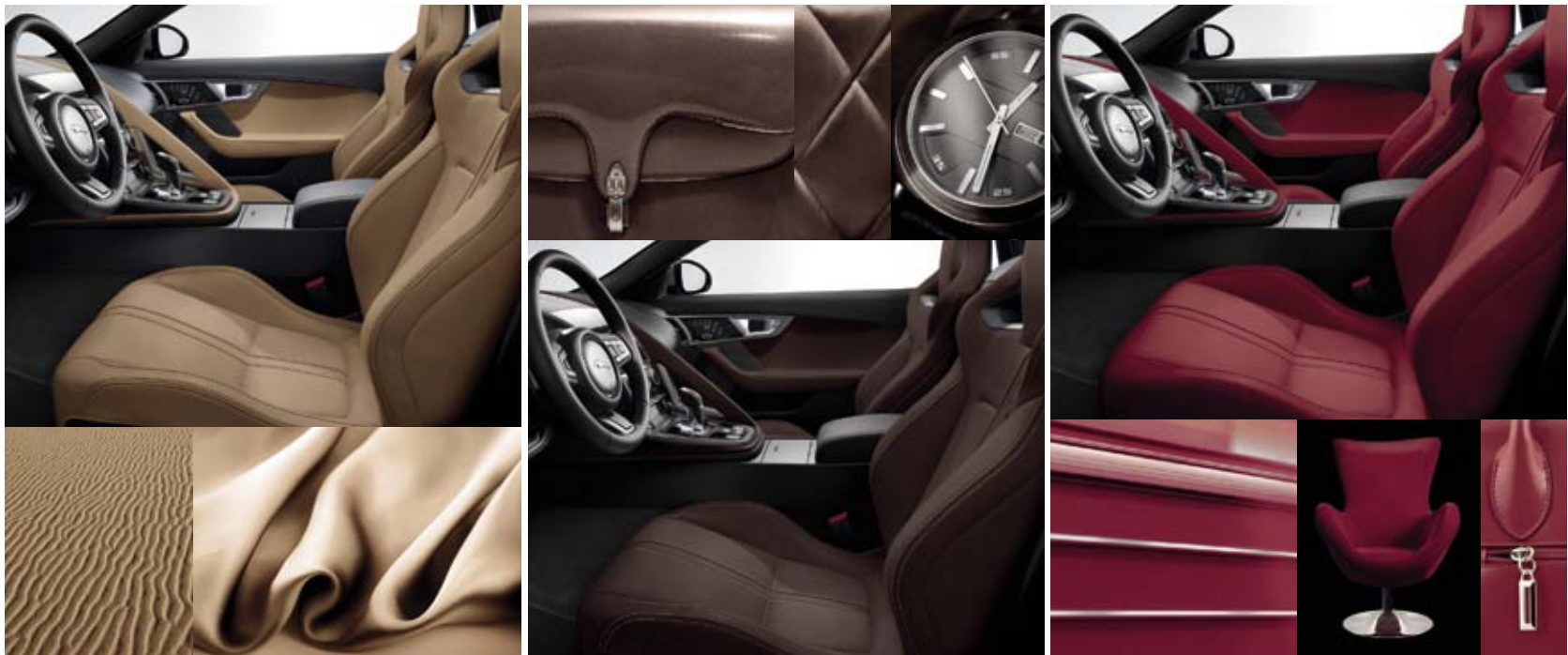

The F-TYPE interior conveys a combination of functional ergonomics with sporting style through its meticulously considered cockpit architecture, its simple controls and its clear instrumentation. It is designed to put the driver first and to be an opportunity for individual expression. Everything offers a rewarding, highly tactile experience with extensive ranges of fine leathers, colors and materials making it more personal. Push the Start button and the car comes alive with a cascade of light from the switchgear. **Configurable Lighting**, standard on the **F-TYPE S** and **F-TYPE V8 S**, adds even greater personalization with choices of Phosphor Blue, Pale Blue, White, Coral or Red to suit the driver's mood. Activate Dynamic Mode and the lighting switches to Red on the door grab handles, center console and instrument cluster.





IN-CAR ENTERTAINMENT



**MERIDIAN™ SOUND
SYSTEM 380W**

**MERIDIAN™ SURROUND
SOUND SYSTEM 770W**

Two superb audio systems bring the cockpit to life with incredible, rich sound.

Two high specification systems were designed in conjunction with British audio experts Meridian™ specifically for the F-TYPE. They feature advanced technology such as Digital Signal Processor (DSP) software to optimize every element of the system and use Meridian™ Cabin Correction's advanced algorithm to redefine the operating parameters and ensure that the audio experience is superbly consistent - roof up and roof down. The standard **Meridian™ Sound System** offers superb audio reproduction through 10 speakers - including 2 sub woofers, 380W and 12 channels. The ultimate **Meridian™ Surround Sound System** features 12 speakers and 770W. This advanced system uses Meridian Trifield™ technology to ensure a perfect sound for both driver and passenger.

VEHICLE SHOWN: F-TYPE S IN SATELLITE GREY





CUSTOMIZATION

It becomes your F-TYPE. The choices you make create the car you'll love. Select the body and roof colors that suit you and choose the ideal wheels to complement them. Tailor your personal interior styling, specifying your ideal seats and choosing the textures and color combinations that will make your F-TYPE unique. With Jaguar's exceptional collection of colors, accessories and options your F-TYPE becomes truly bespoke - your ideal sports car - your ideal F-TYPE.





EXPRESS YOURSELF IN COLOR

SOLID

Ebony



Salsa Red



Polaris White



METALLIC

Indigo*



Ultimate Black*



Stratus Grey*



RACE INSPIRED

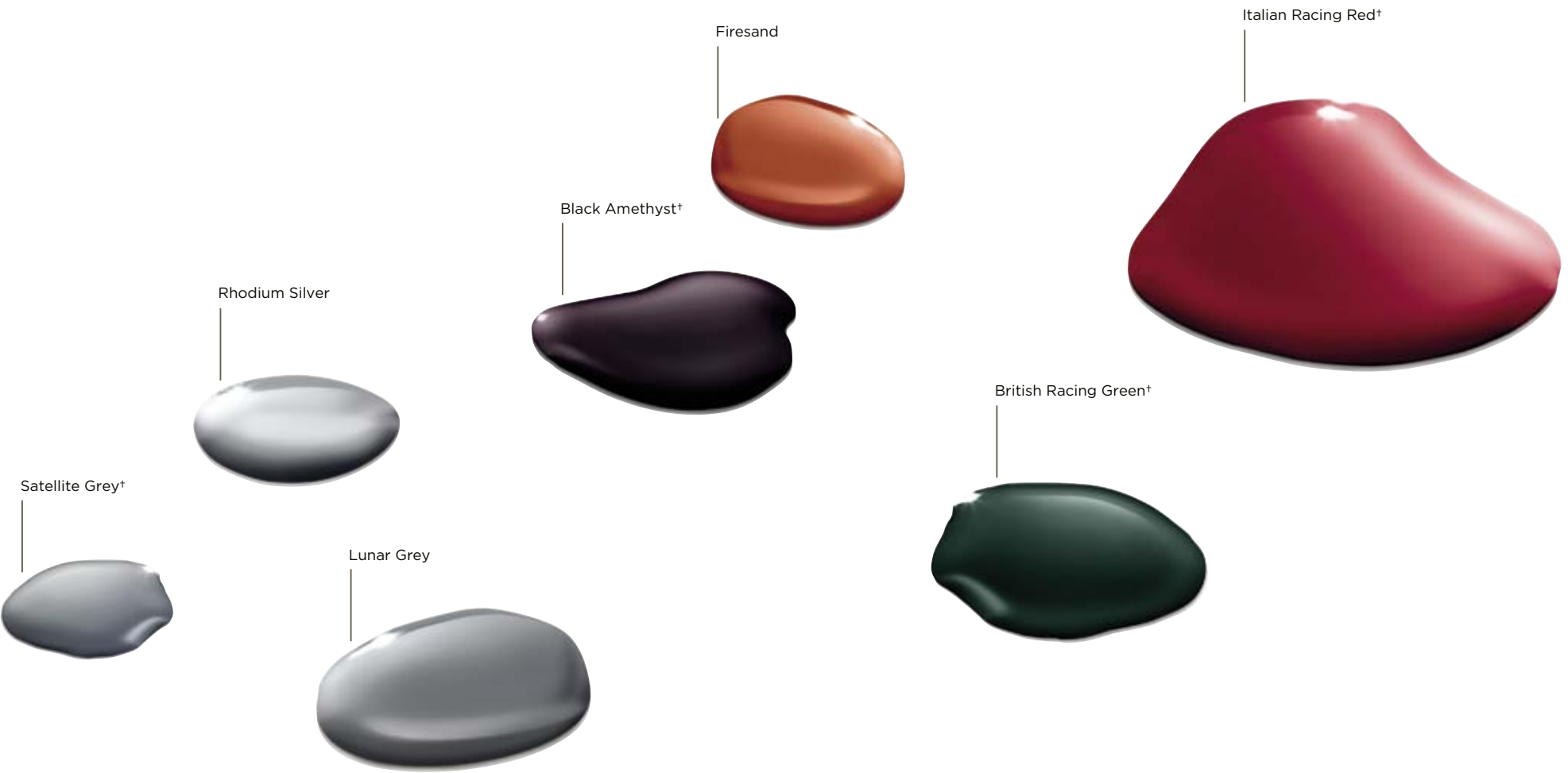

*Xirallic paint

Black Pack, Design Pack and Design Pack with Black Pack available as an option in Ultimate Black, Polaris White, Italian Racing Red, Rhodium Silver, Firesand and Satellite Grey. Also available in other colors as a Retailer Fit Accessory, please contact your local Jaguar retailer for details.

ALLOY WHEELS

Complete the stunning appearance of your F-TYPE with the perfect wheels. Your choice of size, alloy or lightweight forged alloy, spoke patterns and finish - Silver, Gloss Black or Carbon Fiber.

18" ALLOY WHEEL



18" VELA
Standard on F-TYPE

19" ALLOY WHEELS



19" PROPELLER
Standard on F-TYPE S



19" CENTRIFUGE SILVER
Option on F-TYPE and F-TYPE S



19" CENTRIFUGE GLOSS BLACK
Option on F-TYPE and F-TYPE S

 Configure your car at JAGUARUSA.COM/F-TYPE

> 20" ALLOY WHEELS



20" CYCLONE SILVER
Standard on F-TYPE V8 S



20" CYCLONE GLOSS BLACK
Option on F-TYPE V8 S



20" TURBINE
Option on F-TYPE, F-TYPE S and F-TYPE V8 S



20" TORNADO SILVER
Option on F-TYPE, F-TYPE S and F-TYPE V8 S



20" TORNADO GLOSS BLACK
Option on F-TYPE, F-TYPE S and F-TYPE V8 S



20" BLADE FORGED ALLOY
TECHNICAL GREY/CARBON FIBER
Option on F-TYPE, F-TYPE S and F-TYPE V8 S

EVEN THE ROOF IS FAST

The F-TYPE fabric roof offers both light weight and refinement with the outer canopy acoustically enhanced with composite fabric and flush fitting heated rear window glass. The roof can be raised or lowered in just **12 seconds** and operated fully automatically at speeds of **up to 30mph**. Its neat, compact size when folded keeps the rear of the car low and sleek and avoids the need for a tonneau cover - another weight saving. An optional removable wind deflector can also be fitted between the roll over protection bars.²



VEHICLES SHOWN: F-TYPE V8 S IN SALSA RED WITH PERFORMANCE PACK AND OPTIONAL EXTERIOR BLACK PACK



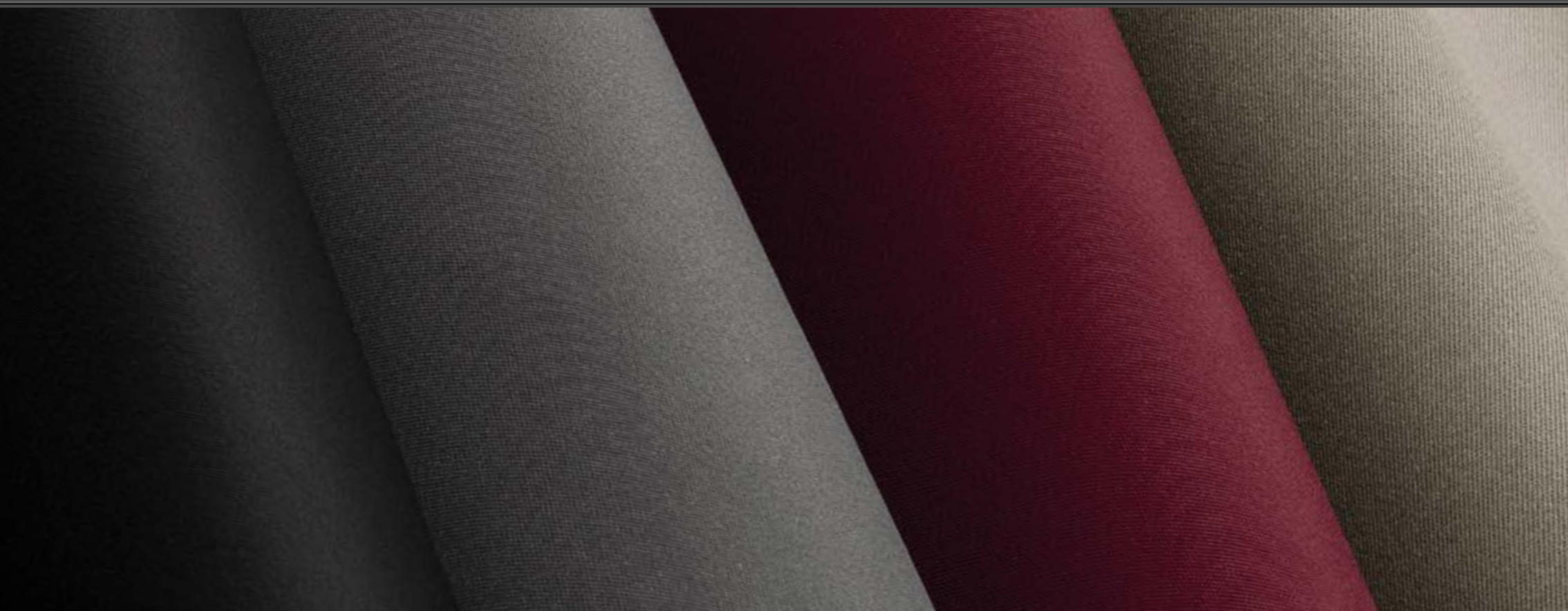

CONVERTIBLE TOP COLORS

Jet

Grey

Red

Beige



SEATS

Two seat styles are available in all models, each offering superb comfort and support. On the **F-TYPE** and **F-TYPE S** the **Sport Seat** with leather and Suedecloth facings and 6-way power and manual adjustment is standard. The **F-TYPE V8 S** models gain the added luxury of full leather facings and 14-way fully-electric adjustment with memory. All models can also be specified with the optional **Performance Seat** which offers enhanced lateral support during rapid cornering, and is upholstered in Premium Leather; it is available as an option on the **F-TYPE** and is part of the Performance Pack on the **F-TYPE S** and **F-TYPE V8 S**. Both Sport and Performance Seats can also be specified with a heated function as part of the Premium or Climate Packs. When combined with the Extended Leather Pack, the Performance Seat can be trimmed in duo-tone leather or contrast stitching. For the finishing touch, it is also possible to choose from Jet, Red or Camel seatbelts.

Now you're ready to choose just the right interior color combination from Jaguar's exclusive collection.



SPORT SEAT



PERFORMANCE SEAT



SEAT TRIM

Jet leather
(Also available in Suedecloth, and Premium leather)

Mineral leather
(Also available in Suedecloth, and Premium leather)

Cirrus leather
(Also available in Suedecloth, and Premium leather)

Red Premium leather

Brogue Premium leather

Camel Premium leather

Ivory Premium leather



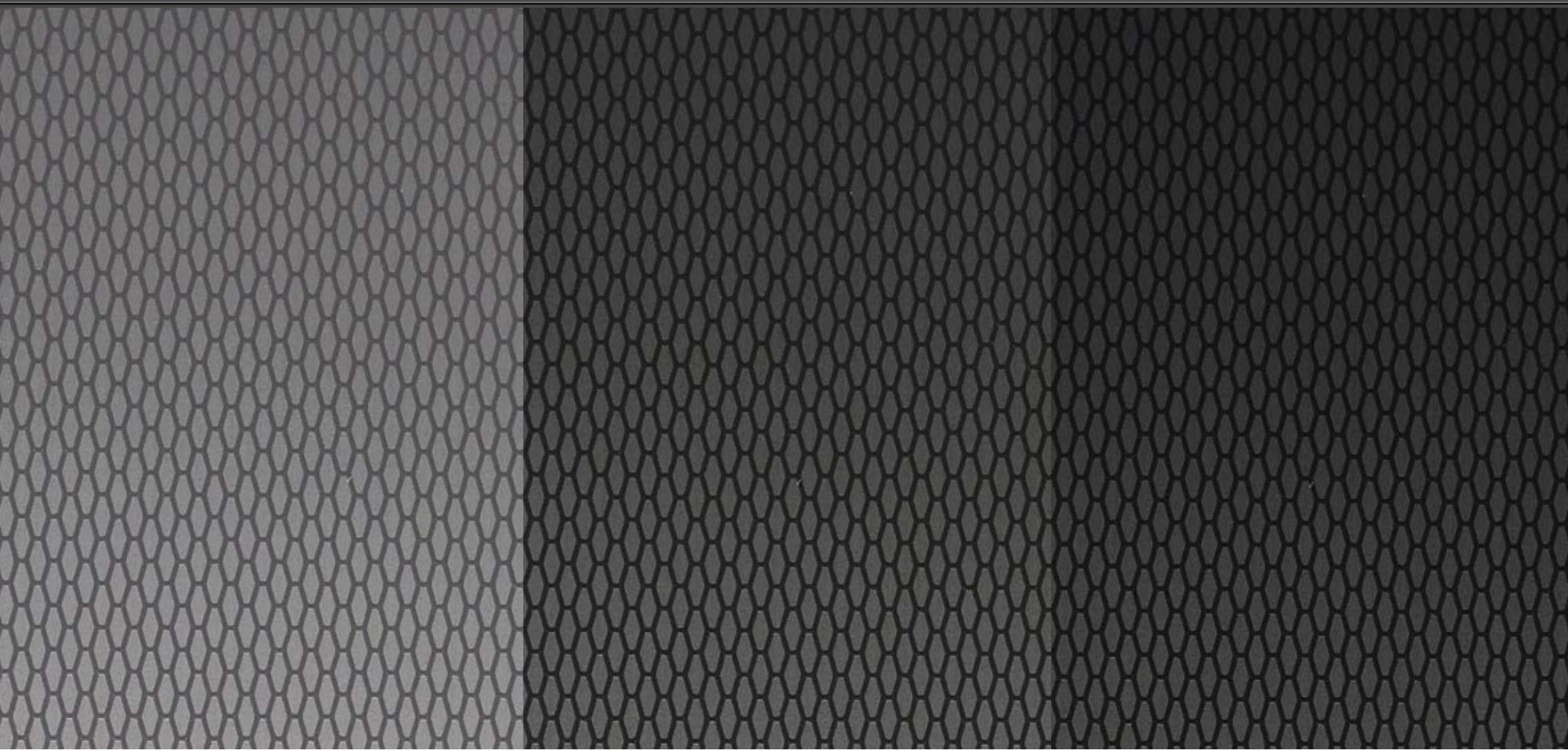

CONSOLE TRIM

Light Hex Aluminum

Dark Hex Aluminum

Black Hex Aluminum



INTERIOR COLOR COMBINATIONS

SPORT SEATS WITH LEATHER AND SUEDECLOTH FACINGS STANDARD ON F-TYPE AND F-TYPE S MODELS



SEAT WITH STITCH

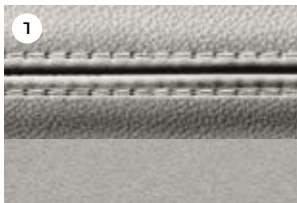

Cirrus with Cirrus

UPPER FASCIA WITH STITCH



Jet with Jet

CONSOLE TRIM



Light Hex

HEADLINING

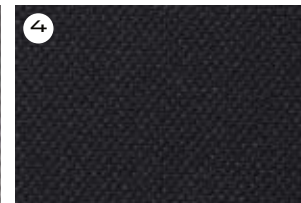

Jet

CARPETS

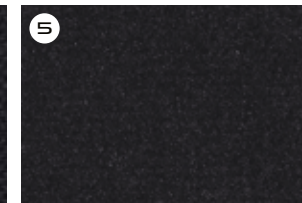

Jet

F-TYPE with Cirrus leather and Suedecloth Sport seats with Jet upper fascia and stitch, Jet Morzine headlining with Light Hex Aluminum console trim and Jet carpets.

1. Seat with stitch - color applies to seats, door trim inserts and door grab handles.
2. Upper fascia with stitch - color applies to dashboard, center console armrest and upper door trims.



SEAT WITH STITCH

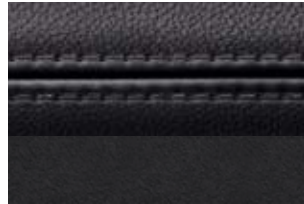

Jet with Jet

UPPER FASCIA WITH STITCH



Jet with Jet

CONSOLE TRIM

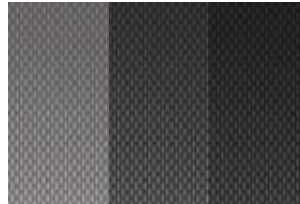

Light, Dark or Black Hex¹

HEADLINING



Jet or Stone

CARPETS

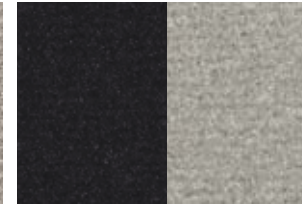

Jet or Cirrus

SEATBELTS



Jet



Mineral with Mineral



Mineral with Mineral



Light, Dark or Black Hex¹



Jet or Stone

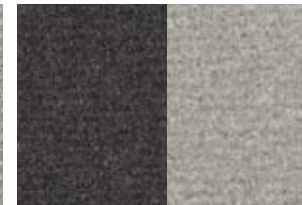

Mineral or Cirrus



Jet

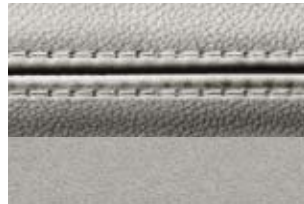

Cirrus with Cirrus

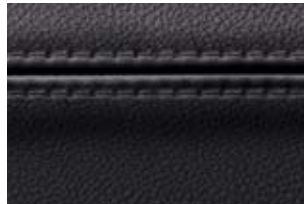

Jet with Jet

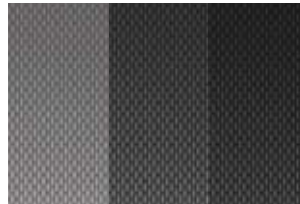

Light, Dark or Black Hex¹



Jet or Stone

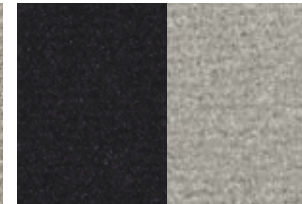

Jet or Cirrus



Jet

¹Black Hex Aluminum console trim only available with Interior Black Pack.

SPORT SEATS WITH LEATHER FACINGS STANDARD ON F-TYPE V8 S, OPTIONAL ON F-TYPE AND F-TYPE S MODELS



SEAT WITH STITCH



Mineral with Mineral

UPPER FASCIA WITH STITCH



Mineral with Mineral

CONSOLE TRIM



Dark Hex

HEADLINING

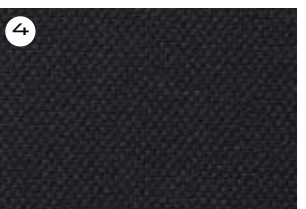

Jet

CARPETS



Jet

F-TYPE S with Mineral leather Sport seats with Mineral upper fascia and stitch, Jet Morzine headlining with Dark Hex Aluminum console trim and Jet carpets.

1. Seat with stitch - color applies to seats, door trim inserts and door grab handles.
2. Upper fascia with stitch - color applies to dashboard, center console armrest and upper door trims.



SEAT WITH STITCH



Jet with Jet

UPPER FASCIA WITH STITCH



Jet with Jet

CONSOLE TRIM

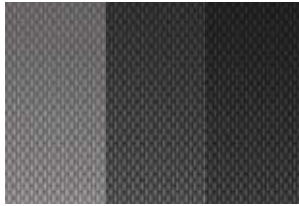

Light, Dark or Black Hex¹

HEADLINING

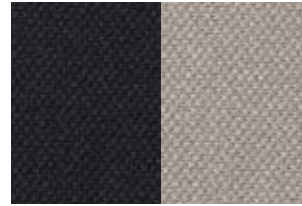

Jet or Stone

CARPETS

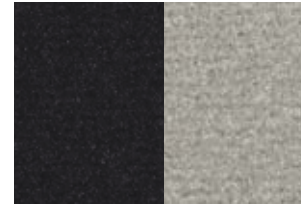

Jet or Cirrus

SEATBELTS



Jet



Mineral with Mineral



Mineral with Mineral

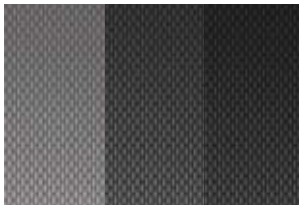

Light, Dark or Black Hex¹

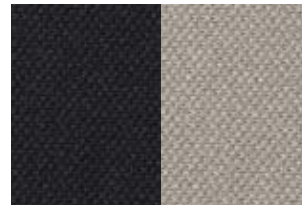

Jet or Stone

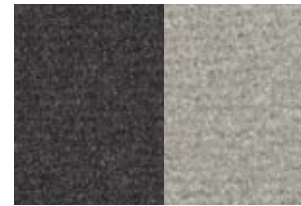

Mineral or Cirrus



Jet

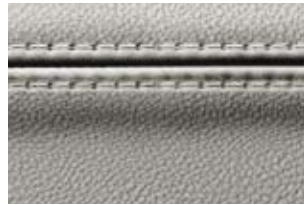

Cirrus with Cirrus



Jet with Jet

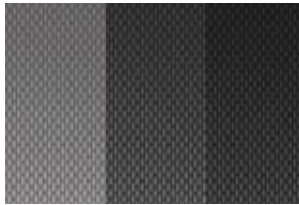

Light, Dark or Black Hex¹

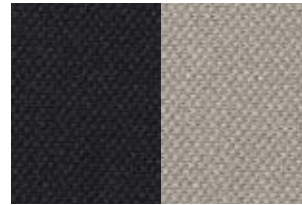

Jet or Stone

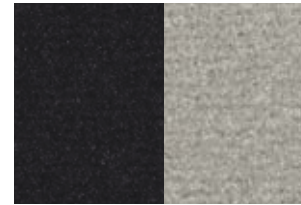

Jet or Cirrus



Jet

¹Black Hex Aluminum console trim only available with Interior Black Pack and Performance Pack.

PERFORMANCE SEATS IN PREMIUM LEATHER

OPTIONAL ON F-TYPE, INCLUDED IN PERFORMANCE PACK ON F-TYPE S AND F-TYPE V8 S



SEAT WITH STITCH

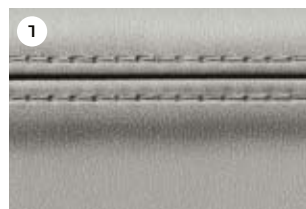

Cirrus with Cirrus

UPPER FASCIA WITH STITCH



Jet with Jet

CONSOLE TRIM



Dark Hex

HEADLINING



Jet

CARPETS



Jet

F-TYPE with Cirrus Premium leather Performance seats with Jet upper fascia and stitch, Jet Morzine headlining with Dark Hex Aluminum console trim and Jet carpets.

1. Seat with stitch - color applies to seats, door trim inserts and door grab handles.
2. Upper fascia with stitch - color applies to dashboard, center console armrest and upper door trims.

SEAT WITH STITCH



Jet with Jet

UPPER FASCIA WITH STITCH



Jet with Jet

CONSOLE TRIM



Light, Dark or Black Hex¹

HEADLINING



Jet or Stone

CARPETS

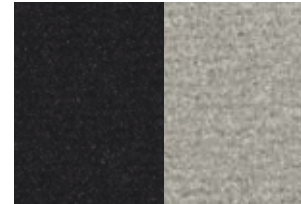

Jet or Cirrus

SEATBELTS



Jet



Mineral with Mineral



Mineral with Mineral



Light, Dark or Black Hex¹



Jet or Stone

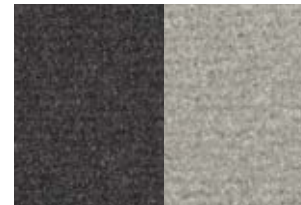

Mineral or Cirrus



Jet

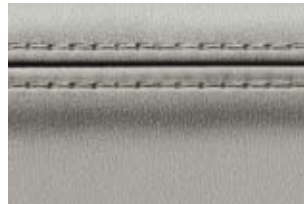

Cirrus with Cirrus



Jet with Jet



Light, Dark or Black Hex¹



Jet or Stone

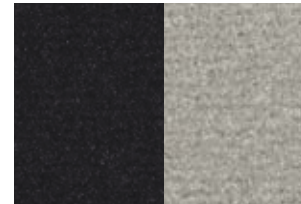

Jet or Cirrus



Jet



Red with Jet



Jet with Jet



Light, Dark or Black Hex¹



Jet or Stone

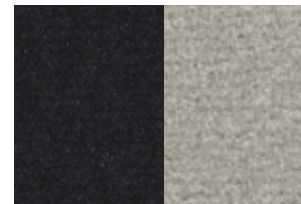

Jet or Cirrus



Jet

¹Black Hex Aluminum console trim only available with Interior Black Pack and Performance Pack.

PERFORMANCE SEATS IN PREMIUM LEATHER WITH EXTENDED LEATHER PACK OPTIONAL ON ALL MODELS WHEN EQUIPPED WITH PERFORMANCE SEATS



SEAT WITH STITCH



Red with Jet

UPPER FASCIA WITH STITCH



Jet with Jet

CONSOLE TRIM

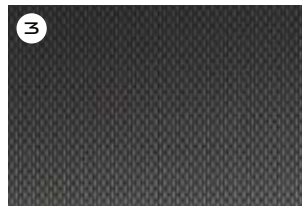

Dark Hex

HEADLINING

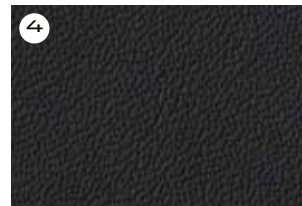

Jet

CARPETS

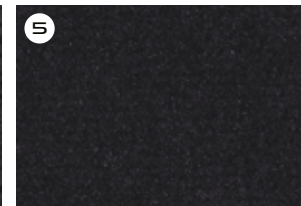

Jet

F-TYPE with Red Premium leather Performance seats with Premium leather interior, Jet leather headlining with Dark Hex Aluminum console trim and Jet carpets.

1. Seat with stitch - color applies to seats, door trim inserts and door grab handles.

2. Upper fascia with stitch - color applies to dashboard, center console armrest and upper door trims.

SEAT WITH STITCH



Jet with Red

UPPER FASCIA WITH STITCH



Jet with Jet

CONSOLE TRIM

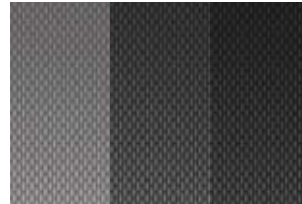

Light, Dark or Black Hex¹

HEADLINING



Jet, Stone or Red Leather

CARPETS

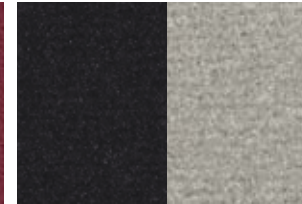

Jet or Cirrus

SEATBELTS



Jet or Red



Jet with Camel



Jet with Jet

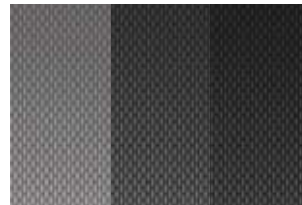

Light, Dark or Black Hex¹

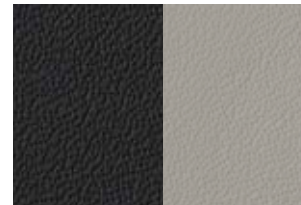

Jet or Stone Leather

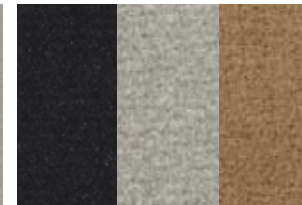

Jet, Cirrus or Camel



Jet or Camel



Jet with Firesand



Jet with Jet

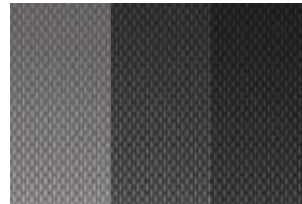

Light, Dark or Black Hex¹

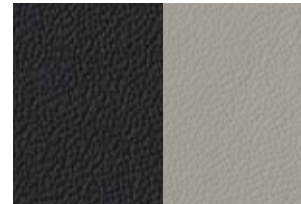

Jet or Stone Leather

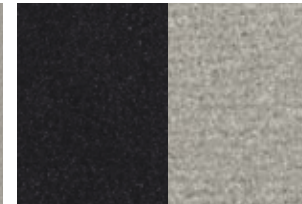

Jet or Cirrus



Jet



Mineral with Cirrus



Mineral with Mineral

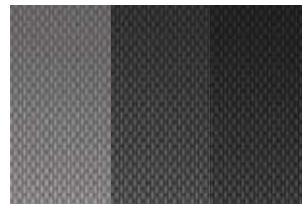

Light, Dark or Black Hex¹

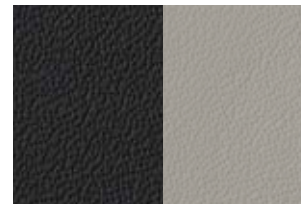

Jet or Stone Leather

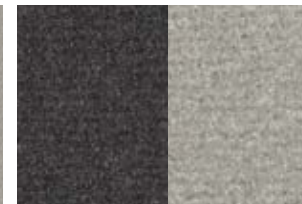

Mineral or Cirrus



Jet

¹Black Hex Aluminum console trim only available with Interior Black Pack and Performance Pack.



SEAT WITH STITCH

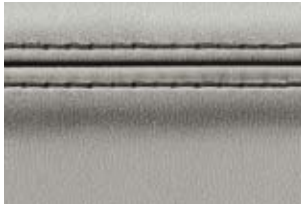

Cirrus with Mineral

UPPER FASCIA WITH STITCH



Jet with Jet

CONSOLE TRIM

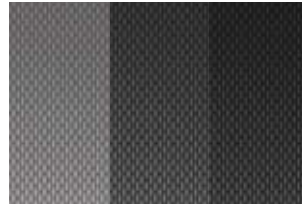

Light, Dark or Black Hex¹

HEADLINING

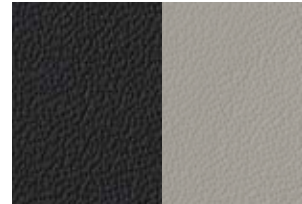

Jet or Stone Leather

CARPETS

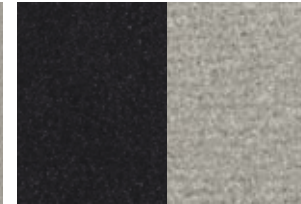

Jet or Cirrus

SEATBELTS



Jet

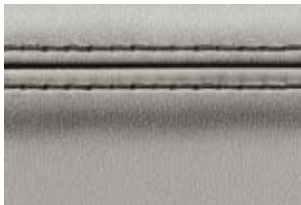

Cirrus with Mineral



Mineral with Mineral



Light, Dark or Black Hex¹

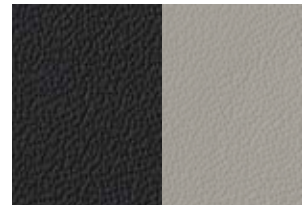

Jet or Stone Leather

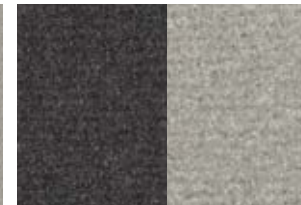

Mineral or Cirrus



Jet



Brogue with Ivory



Jet with Jet

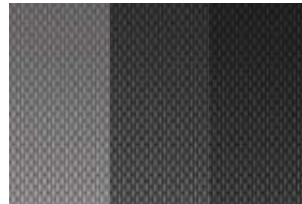

Light, Dark or Black Hex¹



Jet, Stone or Ivory Leather

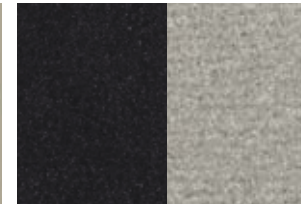

Jet or Cirrus



Jet

¹Black Hex Aluminum console trim only available with Interior Black Pack and Performance Pack.



SEAT WITH STITCH



Red with Jet

UPPER FASCIA WITH STITCH



Jet with Jet

CONSOLE TRIM



Light, Dark or Black Hex¹

HEADLINING



Jet, Stone or Red Leather

CARPETS

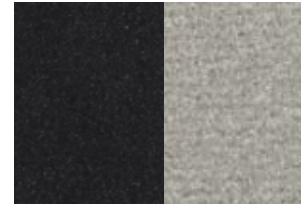

Jet or Cirrus

SEATBELTS



Jet or Red



Camel with Jet



Jet with Jet



Light, Dark or Black Hex¹

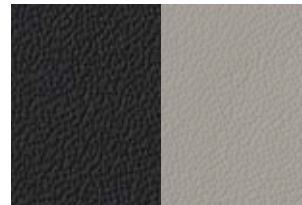

Jet or Stone Leather

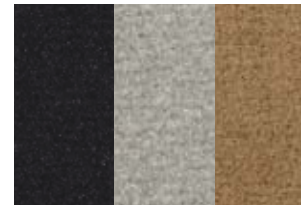

Jet, Cirrus or Camel



Jet or Camel

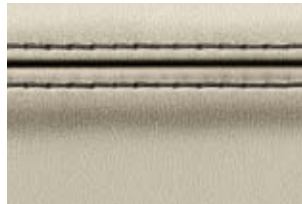

Ivory with Mineral



Mineral with Mineral



Light, Dark or Black Hex¹

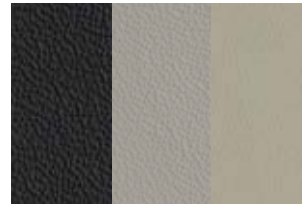

Jet, Stone or Ivory Leather

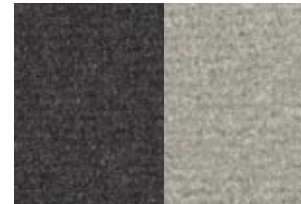

Mineral or Cirrus



Jet

¹Black Hex Aluminum console trim only available with Interior Black Pack and Performance Pack.

ADDED ATTITUDE, ADDED OPTIONS

DESIGN PACK AND BLACK PACK*

The F-TYPE's strong visual assertiveness can be further enhanced thanks to the availability of two exciting options - **Design Pack** and **Black Pack**. The Design Pack features body colored sill extensions, front aerodynamic splitters and a Gloss Black rear valance and, on **F-TYPE** and **F-TYPE S** models only, a color-keyed rear venturi. The Black Pack features a Gloss Black finish on the front grille and surround, as well as to the bumper beam, hood louvers and front splitter. The Gloss Black finish also extends to the front outer meshes, side power vents, rear valance and the roll over protection bars.²



DESIGN PACK

1. Body colored front bumper splitter **2.** Body colored aerodynamic splitters **3.** Body colored side sill extensions **4.** Gloss Black rear valance **5.** Body colored rear bumper venturi

*Pack content varies with model



INTERIOR BLACK PACK*

1. Gloss Black air vent surrounds and door switch pack surrounds 2. Flat-bottomed Sport steering wheel with Gloss Black trim finisher 3. Gloss Black Instrument Cluster Dial Rings 4. Black Hex Aluminum console trim



EXTERIOR BLACK PACK

1. Gloss Black finish to front grille and surround, bumper beam, front splitter and front outer meshes 2. Gloss Black hood louvers 3. Gloss Black side power vents 4. Gloss Black rear valance and Roll Over Protection Bars

*Part of the Performance Pack on F-TYPE S and F-TYPE V8 S

ACCESSORIES

A wide range of high quality accessories is available from your Jaguar retailer. They are all designed to complement your lifestyle, add further individuality or enhance practicality.



STAINLESS STEEL PEDAL COVERS

Made from stainless steel and rubber, the pedal kit fits securely over existing pedals for a contemporary, sporting appearance.



CARBON FIBER ENGINE COVER

Add a dynamic flair to your F-TYPE with this lightweight Carbon Fiber engine cover.



WIND DEFLECTOR

Reduce wind in the cabin with this easy to install, quick to remove, wind deflector.

CARBON FIBER ROLL OVER PROTECTION BARS

Accentuate your F-TYPE's contemporary sporting style with these Carbon Fiber Roll Over Protection Bars.²

For Accessory Options and availability please check with your Jaguar retailer.



**20" BLADE FORGED ALLOY
TECHNICAL GREY/CARBON FIBER**

Add your own style to your F-TYPE with these striking forged 20 inch wheels. Featuring high-grade Carbon Fiber inserts and Jaguar's dynamic 'Blade' design.



CARBON FIBER MIRROR COVERS

Accentuate the dynamic design of your F-TYPE exterior mirrors and add further individuality to its sporting character.



CARBON FIBER HOOD LOUVERS

Emphasize one of the most distinctive features of your F-TYPE with these high-grade Carbon Fiber Hood Louvers.



F-TYPE OWNERSHIP EXPERIENCE

Service, assurance, and peace of mind are all part of the pride of owning your new F-TYPE.

TOTAL CARE

Seamless support for your new Jaguar car, so you can relax and drive. A combination of vehicle warranty, paint and corrosion protection and Jaguar Assistance.

WARRANTY⁽¹⁾

Jaguar Cars offers a comprehensive, 4-year/50,000 miles New Vehicle Limited Warranty as well as a 6-year/unlimited mileage Corrosion Protection Limited Warranty.

JAGUAR ASSISTANCE⁽²⁾

Handled by Jaguar-trained specialists, this incident management program provides complimentary towing service, jump-starts, lockout assistance, gasoline delivery, tire changes and trip routing help, 24/7. Just call 1.800.4. JAGUAR (1.800.452.4827).

JAGUAR FINANCIAL GROUP

Available both for individuals and businesses, Jaguar Financial Group offers leasing and financing packages that can meet most needs. Ask your local authorized Jaguar retailer for details.

JAGUAR RETAILER EXPERIENCE

Jaguar ownership begins with a first class retailer experience. It continues with the outstanding support from retailer service teams dedicated to maintaining your vehicle's condition and performance. You will find only the best factory-trained technicians at authorized Jaguar retailers.

JAGUAR VEHICLE ACCESSORIES[†]

Jaguar vehicle accessories enable you to personalize your car, to create a driving experience that is even more individually rewarding. All Jaguar accessories are tested rigorously for safety and durability in the most arduous of climates and conditions. With a comprehensive range of styling options and interior and exterior accessories, you can tailor your Jaguar vehicle to suit your personal style. What's more, every accessory is covered for 12 months unlimited mileage or the balance of the New Vehicle Limited Warranty, whichever is greater. Genuine Jaguar vehicle accessories are covered by a warranty that begins on the date of purchase of the accessory and are covered for 12 months or unlimited mileage, or the balance of the new vehicle/emissions warranty, whichever is greater.

JAGUAR MAGAZINE

Jaguar Magazine is the official magazine of Jaguar Cars. It features stories about the full Jaguar line-up and the worlds of luxury, style, design and travel. Also available, a fully interactive iPad® app takes the very best of the print edition of the Magazine and adds extra images and exclusive information, allowing you to explore the world of Jaguar in a whole new way.

JAGUARUSA.COM

Visit the official web site to access the retailer locator, car configurator, price lists, model comparisons and more. Sign up for "Keep Me Informed" to receive all the latest news and special offers.

⁽¹⁾See your authorized Jaguar retailer for complete terms and conditions of limited warranty coverage.

⁽²⁾All elements of Jaguar Assistance are available only while your Jaguar New Vehicle Limited Warranty is in effect.

[†]All Jaguar approved accessories are rigorously tested to the same exacting standards as those applied to our vehicles. Performance in extreme hot and cold temperatures, corrosion resistance, impact and airbag deployment highlight some of the exhaustive product testing carried out so that Accessories are both durable and importantly, continue to comply with current laws.



VEHICLE SHOWN: F-TYPE S IN SATELLITE GREY WITH OPTIONAL PERFORMANCE PACK AND CARBON FIBER EXTERIOR ACCESSORIES





IMPORTANT NOTICE

Jaguar Land Rover Limited is constantly seeking ways to improve the specification, design and production of its vehicles and alterations take place continually. While every effort is made to produce up to date literature, this brochure should not be regarded as an infallible guide to current specification, nor does it constitute an offer for the sale of any particular vehicle. Distributors and dealers are not agents of Jaguar Land Rover Limited by any express or implied undertaking or representation.

ENVIRONMENTAL INNOVATION AT JAGUAR

Jaguar is proud to continue the company's tradition with its approach to Environmental Innovation. From the choice of lightweight materials and lean production methods to the efficiency of its engines and designs, Jaguar is committed to operating as a more sustainable business and reducing its overall environmental impact.

Jaguar's flagship XJ model was the first in the company to achieve ISO 14040, the international standard for vehicle 'whole life cycle' assessment. This certification measures the environmental impact of XJ from component material sourcing and manufacturing process, through its driven life time, to final disposal. But that's not all. Every new Jaguar vehicle is designed to be 85% recyclable and reusable, in addition 95% recoverable and reusable with 10% potentially for energy generation.

The XJ, F-TYPE and XK's innovative use of lightweight aluminum, which incorporates up to 50% recycled material from the manufacturing process in the body structure, provides considerable performance benefits. This includes improved fuel consumption, and less CO₂ emissions as well as the dynamic performance inherent in its weight saving design.

Jaguar is committed to reducing dependency on fossil fuels, using fewer resources and creating less waste. Already the manufacturing assembly CO₂ emissions of each Jaguar built in the UK since 2009 is offset. For every ton of CO₂ emitted in the assembly process, Jaguar invests in carbon reduction projects that reduce an equivalent ton of CO₂ elsewhere.

Offsetting allows Jaguar to take action now, to reduce its impact on the environment, as part of an integrated carbon management plan. The company plan includes targets to reduce operating CO₂ emissions and waste to landfill by 25% by March 2013 and European fleet average tailpipe CO₂ emissions by 25% by 2015. All targets are based on 2007 levels.

But it doesn't stop there. We have been awarded Platinum status in the Corporate Responsibility Index 2012 from the UK's Business in the Community, in recognition of our 360 degree approach to sustainable development.

That's Environmental Innovation at Jaguar.

VEHICLE SHOWN: F-TYPE S IN SATELLITE GREY

'Trifold'[™] and the 'three fields' device are trademarks of Trifold Productions Ltd. iPod, iPod touch and iPad are trademarks of Apple Inc., registered in the U.S. and other countries. The Bluetooth word mark and logos are owned by Bluetooth SIG, inc. and any use of such word marks by Jaguar Land Rover Limited is under license. Meridian[™] is a trademark of Meridian Audio Ltd.

¹ Always follow local speed limits.

² These features are not a substitute for driving safely with due care and attention and will not function under all circumstances, speeds, weather and road conditions, etc. Driver should not assume that these features will correct errors of judgment in driving. Please consult the owner's manual or your local authorized Jaguar Retailer for more details.

³ Driving while distracted can result in loss of vehicle control. Do not operate, adjust or view the navigation or multimedia systems under conditions that will affect your safety or the safety of others. Only use mobile phones and other devices, even with voice commands, when it is safe to do so.



