

1981



C J - 5 / C J - 7

JEEP®

Jeep CJ, The Legend Endures.

Jeep...the legend that has endured for 40 years. It all began with a tough quarter-ton military vehicle, predecessor of today's Jeep CJ. It carried America's colors proudly and reliably through the searing Sahara in North Africa...up the beaches at Normandy...over the sands of Iwo Jima. Wherever and whenever a dependable personnel and materials carrier was needed during World War II, that steady, spunky all purpose vehicle was there.

After a very distinguished tour of duty, that forerunner of the modern Jeep CJ moved on to other fertile fields in agriculture, land surveying, forestry and conservation service...wherever a scrappy, dependable, go-anywhere-anytime utility vehicle was needed.

Then came the incomparable CJ, the amazing Jeep vehicle that almost single-handedly

launched the Recreational Vehicle industry.

We put our first Jeep CJ-5 on the back trails of America in 1954. Now, several hundred thousand CJs later, it's difficult to tell where the city leaves off and Jeep Country begins, because today's Jeep CJs are built for off-roaders who also want the convenience of a sporty in-town runabout. If you need proof, count the Jeep vehicles in the parking lot the next time you go to the shopping center, or theater, or for that matter anywhere.

That brings us to 1981, and the newest edition Jeep CJ. One with all the off-road prowess you expect from the leader in 4-wheel drive technology...one every bit as rugged and dependable as its forebearers...yet one with surprising convenience, comfort and room...one with good measures of value, performance and long term quality so important for the '80s.

The legend lives on.



The legendary Military Model MB of World War II fame.



Jeep CJ

Durable Jeep CJ comes in two configurations. The CJ-5 has a tidy 83.5-inch wheelbase that lets it turn in where larger 4WDs turn back. And the versatile CJ-7 offers a 93.5-inch wheelbase for optimum driving satisfaction and riding comfort on road or off.

Both come bristling with popular standards. Free-wheeling front hubs let you select 2-wheel or 4-wheel driving mode as needed. A folding windshield, solid state ignition, fuel tank skid plate, roll bar, front disc brakes, steering damper and front sway bar are some of the other important standard features.

The gutsy, 151 CID (2.5 liter) 4-cylinder engine and a fully synchronized, 4-speed, manual transmission continue as the standard powerteam. They helped make last year's CJ the mileage champ among domestic 4WDs and we're even better for '81: 27 hwy est mpg, (22) EPA est mpg.

Use these figures for comparison. Your results may differ due to driving speed, weather conditions and trip length. Actual highway mileage will be less. California figures were not available at time of publication. Consult your Jeep Dealer.

The solid, 258 CID (4.2 liter) 6-cylinder engine, available on CJ, has shed 90 lbs to provide improved performance and practicality during the fuel conscious 80s. And when you order CJ-7 with the Six and automatic transmission, a new "lock-up" torque converter helps improve highway efficiency.†

A handy option not available last year is a wide-ratio automatic transmission for 4-cylinder CJ-7s.

† See EPA mileage statement on back cover.



CJ-5 Laredo



CJ-5 Renegade



CJ-7



CJ-7 Renegade

Appearance & Equipment Packages:

This year you can top Jeep CJ with vinyl or denim soft-top with either soft doors, or, on CJ-7, steel doors with roll up windows. You have a choice of four colors including new Nutmeg. A smart molded hardtop, in a choice of 3 colors is also available for CJ-7.

Just as it comes from the factory, Jeep CJ is a mighty exciting vehicle to look at. It often gathers an admiring crowd just parked on the street. However, many CJ owners prefer the distinctiveness and extra comfort provided in bold, attractive Jeep CJ special option packages.

Renegade.

"Renegade" fans will quickly note this year's prominent new graphic treatment. The basic package is available on either CJ-5 or CJ-7 and includes:

- Convenience Group: courtesy lights; 8" day/night mirror; underhood light.
- White 15 x 8 styled wheels.
- L78 x 15 Goodyear Tracker P/G OWL tires.
- Wheelip extensions.
- Spare wheel lock.
- Decor Group: rocker panel protection molding; instrument panel pad; Soft Feel sports steering wheel; front frame cover.
- Exterior graphics available in gradations of yellow, blue or red, depending on base exterior color.
- High back vinyl front bucket seats and rear bench seat trimmed in black, blue or nutmeg denim-look vinyl depending on base exterior color.
- "Renegade" can be ordered with all regular production exterior colors.

Jeep CJ

Laredo.

The dramatic high-styled CJ "Laredo" offers exciting color combinations and plenty of top-of-the-line distinction for CJ-5 with soft-top, or CJ-7 with soft-or hardtop. The package includes:

- Convenience Group: courtesy lights; 8" day/night mirror; underhood light.
- Chrome plated 15 x 8 styled steel wheels, and die-cast hub covers.
- Chrome front bumper, rear bumperettes, swing-away spare tire carrier latch and stop, grille panel (with pinstripe), mirror heads and arms, footman loops.
- 9R-15 Goodyear Wrangler radial tires.
- Wheelip extensions.
- Black rocker moldings.
- Heavy duty shocks.
- Hood insulation.
- Tachometer and clock.
- Instrument panel pad (black or nutmeg).
- Special exterior striping and "Laredo" lettering in silver and gray, or nutmeg and bronze, depending on base exterior color.
- Tinted-glass quarter windows on CJ-7 hardtop models (gray-tone with black top, bronze-tone with nutmeg top).
- Special interior trim: black or dark nutmeg indoor/outdoor carpeting; special high back front bucket seats in black with gray vinyl accent straps or nutmeg with honey accents, and matching rear bench seat; leather-wrapped steering wheel and passenger assist bar; specially trimmed console; special door trim panels; special pinstriping and "Laredo" nameplate on instrument panel.
- "Laredo" package is available with eight regular production exterior colors. Check your Jeep dealer for specific color availability.



Interiors



Off-roaders looking for a little style with their action have some tough (but beautiful!) decisions to make. The "Renegade" CJ features smartly contoured high back buckets dressed in sporty denim-look blue, black or new nutmeg vinyl with matching rear bench. The "Laredo" CJ is just about as posh as you can get with black or nutmeg indoor/outdoor carpeting front and rear, a smart center console, special door and instrument panel trim, black leather-wrapped sport steering wheel, black or nutmeg leather-wrapped passenger assist handle, and the form fitting high back buckets and rear bench seat are trimmed in elegant Cara Grain vinyl in black with gray strap design, or nutmeg and honey accent strap.

Even the four-wheeling purist will be pleasantly surprised by the handsome standard CJ buckets, neatly tailored in beige or black linen grain vinyl.



151 CID, 4-cylinder



Fold down windshield



Free-wheeling front hubs

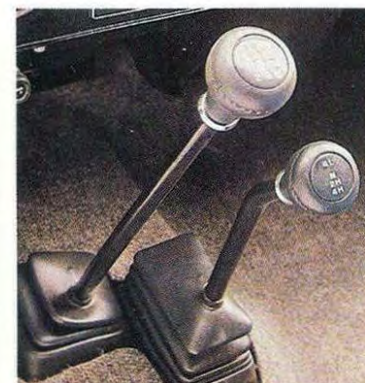

Part-time 4WD transfer case/ 4-speed transmission



Rear swingaway spare tire carrier and tailgate

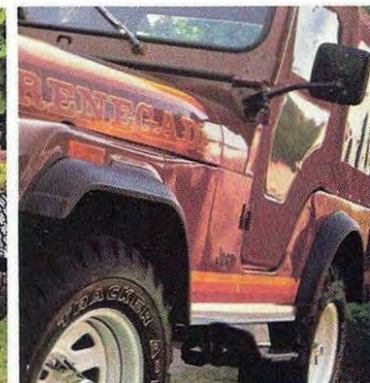

Wheelip extensions

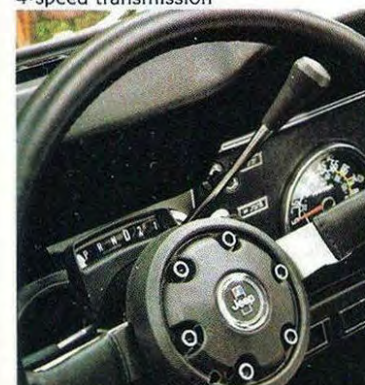

Automatic transmission



Soft top, steel doors

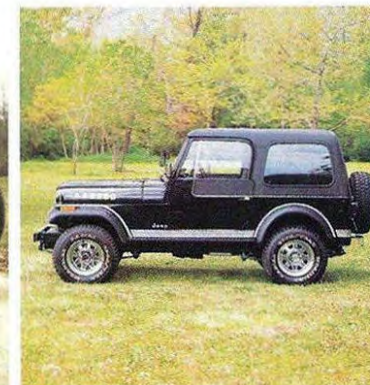

Hard top

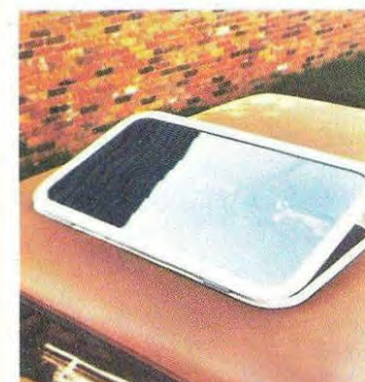

Sun roof

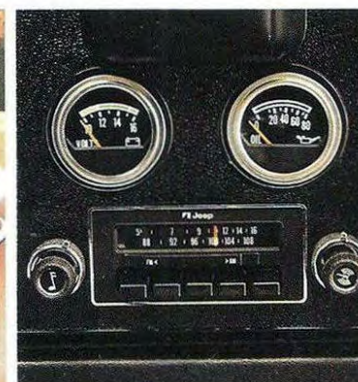

AM/FM/stereo radio

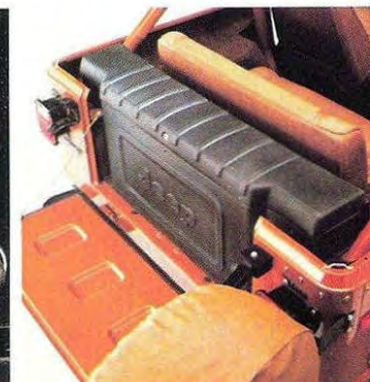

CJ lockable storage area

Standard Features & Options

Standard:

- Air Cleaner—cellulose fiber
- Alternator—12-volt, 42-amp
- Ash tray with cigar lighter
- Battery—12-volt, 55-380 cold cranking amps
- Brakes—self adjusting front disc/ rear drum
- Electronic High Energy Ignition
- Engine—151 CID (2.5 liter) 4-cylinder
- Engine coolant—Permanent type with hi-temp thermostat (50-50 mix)
- Exhaust system—single
- Free-wheeling front hubs
- Front stabilizer bar and steering damper
- Fuel filter—tank and in-line at carburetor
- Glove box
- Gauges—oil, ammeter, temp & fuel
- Heater & defroster
- Horn—single note
- Lights—head, parking, tail & stop, directional signal, side marker & 4-way hazard warning flashers
- Mirrors—inside, 8" rearview; outside, driver & passenger side rearview
- Padded sunvisors (2)
- Passenger safety rail
- Rear spare tire mount—fixed on CJ-5, swing-away on CJ-7
- Roll bar
- Seat belts (lap)
- Seats—Two front bucket seats
- Skid plate fuel tank, transfer case
- Steering wheel—3-spoke, black, molded polypropylene
- Tailgate—moveable (CJ-7 only)
- Tires—H78 x 15 Polyester Cruiser 78 black sidewall
- Transmission—4-speed manual, fully-synchronized with hydraulically actuated clutch
- Washer/Wiper system—2-speed, electric
- Wheels—5-bolt 15" x 5.5"
- Windshield—fold down

Options:

- Automatic transmission (CJ-7 only)
- Air conditioning (N/A 4-cyl)
- Alternator—heavy duty
- Battery—heavy duty
- Bodyside step

Options (cont'd.)

- Bumperettes (incl. in Laredo Pkg.)
- Carpeting—front and rear
- Center console
- Convenience Group: courtesy lights; underhood light; 8" day/night mirror (incl. in Renegade & Laredo pkgs.)
- Decor Group: rocker panel protection molding; instrument panel pad; instrument panel overlay; soft feel sports steering wheel; front frame cover
- Draw bar
- Engines: —258 CID Six
—304 CID V-8 (N/A Calif.)
- Heavy duty cooling
- Instrument panel pad
- Lights: —Fog lamps with clear lens
—Quartz Halogen Headlamps
- Sun roof (CJ-7 with hardtop)
- Power disc brakes (front)
- Power steering
- Radio: —AM with antenna
—AM/FM stereo with antenna
- Rear storage box—lockable
- Seat—rear bench
- Steering wheel: —soft feel sports (incl. in Renegade pkg.)
- Steering Wheel: —leather-wrapped (incl. in Laredo pkg.)
- Suspension: —extra duty
- Tailgate—moveable (std. on CJ-7)
- Tires
- Tops—soft top, soft top w/steel doors (CJ-7 only), molded hardtop (CJ-7 only)
- Trim Packages—Renegade & Laredo
- Utility group: bumper extensions; tow hooks, rear bumperettes
- Wheel covers—full
- Wheels—styled steel, painted; styled steel, chrome

See your dealer for a complete list of options and factory approved accessories.

Colors



Electric winch—dealer installed

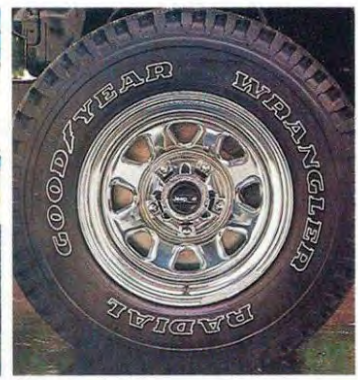

Wrangler tire



Sun bonnet top—dealer installed

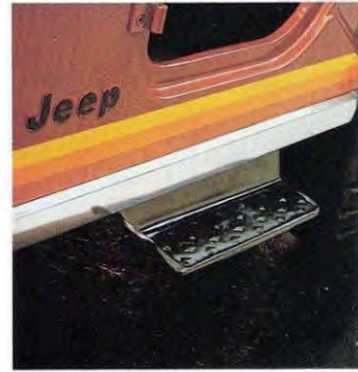

Bodyside step



CJ snowplow—dealer installed



Ski carrier—dealer installed



Roll bar padding/saddle bags



Radiator screen, brush guard and fog lamps

Jeep Store
GENUINE JEEP PARTS AND ACCESSORIES ARE AVAILABLE ONLY FROM THE JEEP STORE... YOUR LOCAL JEEP DEALER.

4WD Systems

40 years of design innovation in 4-wheel drive systems has taught us a lot. Nobody engineers 4-wheel drive systems like Jeep does, because nobody knows more about 4-wheel drive. The part time system that comes with every CJ is a superlative example. It's rugged, dependable, built to take all the off road demands you ask of it in stride. And its designed with light-weight componentry that doesn't sacrifice toughness. That's increasingly important as we move through the 80s, and as more 4-wheelers start using their vehicles for conventional driving needs.

In highway situations you simply slip the transfer case shift lever to the 2-wheel mode and unlock the front hubs. Now the front propeller shaft, front differential and front

driving axles are disengaged. Friction and noise are reduced, and peak on-road operation is obtained.

For off-road action, just lock the front hubs, shift the transfer case to the 4-wheel mode and CJ becomes the lively go-anywhere-anytime fun machine that has become the standard of the world for off-road recreational use.

The Jeep CJ part-time four-wheel drive system is teamed with a standard 4-speed, fully synchronized, manual transmission. CJ-7 offers an available automatic transmission teamed with part time 4WD system with 4-cylinder, Six cylinder or V8 engines. The automatic transmission on CJ-7s with optional Six or V8 engines features a lock-up torque converter for improved performance.

4WD Activities



Tires

Cruiser flexible polyester cord diagonal ply tires are strong, smartly styled and provide good traction. H78 x 15—B/W

Surbanite tires are designed for strength and super pulling power in mud and snow. H78 x 15—B/W L78 x 15—B/W

Wrangler steel radial tires bite deep in mud, sand and snow, are smooth and stable on the highway. 9R x 15—OWL

Tracker PG is a rugged polyglas belted tire that's smooth on the highway—and off! A great 4-WD tire! L78 x 15—OWL

Tracker A-T tires are a wide, all-terrain, all-weather tire designed for durability and rugged 4-WD use. 9 x 15—OWL

4WD Activities

Jeep CJ is the first choice of more professional and amateur four-wheelers than any other single vehicle. At sanctioned off-road races and organized club events around the globe you'll find CJs at the head of the pack.

We take an active role in 4-wheeling to learn how to keep our systems rugged and dependable while improving on design and efficiency, and to promote positive action on the part of off-roaders.

As an advisory member of the United Four Wheel Drive Associations we are committed to the promotion of off-roading as a safe, positive, responsible recreational pursuit.

Vehicles illustrated in this brochure may vary slightly from actual production models.
This folder does not constitute an offer or commitment to sell. In order that product improvements may be made at any time, specifications and other data are subject to change without notice. Jeep vehicles incorporate thousands of different components produced by Jeep Corporation, affiliated companies and various independent suppliers. From time to time during the manufacturing process, it may be necessary to produce Jeep vehicles with different components or differently sourced components than initially scheduled. All components must meet the standards of Jeep Corporation and will provide the performance expected from Jeep vehicles. Jeep vehicles meet or exceed all applicable Federal Motor Vehicle Safety Standards at time of manufacture. Some of the Jeep vehicles shown and described in this brochure have optional equipment. JEEP, CJ, QUADRA-TRAC, RENEGADE, JEEP STORE, LAREDO and the JEEP CJ Grille Design are trademarks of Jeep Corporation. In Canada, American Motors (Canada) Limited is a licensed user. Reg. TM.
Merchandising/Jeep Sales Promotion 8/80 FORM#: 1-5424-835-01



Jeep CJ Specifications

CJ Dimensions

(inches unless otherwise noted)

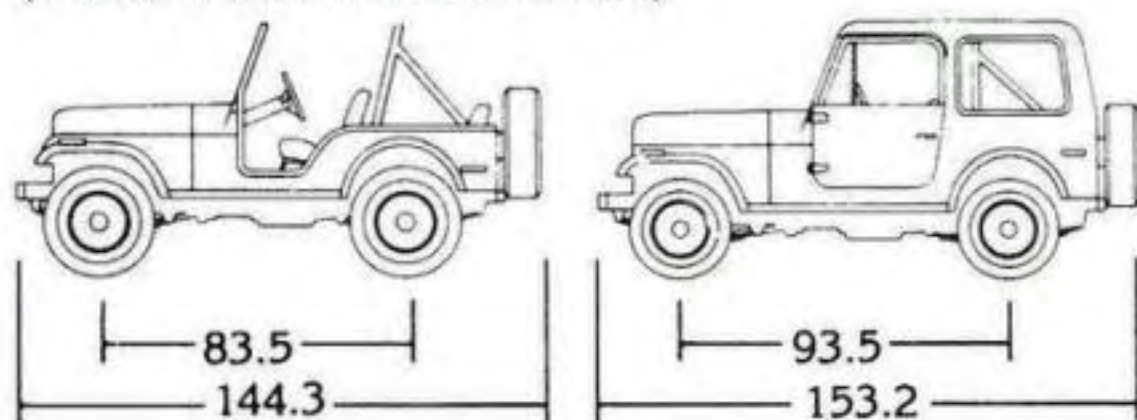

Exterior	CJ-5	CJ-7
Length	144.3	153.2
Wheelbase	83.5	93.5
Maximum Body Width	59.9	59.9
	68.6(1)	
Height	67.6	67.6/70.5(2)
Tread (front/rear)	51.5/50.0	51.5/50.0
Overhang (front/rear)	23.5/27.8	23.5/27.3
Min. ground clearance	6.9	6.9
Tailgate opening width	35.8	34.5
Turning diameter, Curb to curb (feet)	33.5	35.9
Interior		
Head room, soft top	39.8	40.6
hardtop (front/rear)	40.8/40.9	39.9/39.6
Leg room, front (max.)	37.9	39.1
rear (min.)	30.5	35.0
Hip room (front/rear)	55.4/36.0	53.8/36.0
Shoulder room (front/rear)	55.4/55.4	53.8/56.3
Cargo volume (cu. ft.)	10.2	13.6

(1) With side mounted spare tire (2) Hard top

Specifications

Axle, front	Full floating open end; GAWR: 2200 lbs.
Axle, rear	GAWR: 2700 lbs.
Brakes	Manual front disc/rear drum (Power assist optional)
Clutch, diameter	9.12 (4 cyl.) 10.5 (6 & 8 cyl)
Clutch, area	71.78 (4 cyl) 106.75 (6 & 8 cyl)
Fuel tank capacity	15 (approx.) gallons (w/skid plate) std.
4WD system	Part-time, with lockable manual free-wheeling front hubs. Available with automatic transmission (CJ-7)
Transfer case	2-speed Part-Time with 2.62 low range gear reduction
Glass area	768 sq. in. without top
Gross vehicle weight	3750 lbs. (4150 lbs. Max.)
Springs, front	4 leaf 170 lbs./in. rate std.
Springs, rear	4 leaf 185 lbs./in. rate std. 5 leaf 185 lbs./in. rate std. (hardtop)
Steering	Recirculating ball standard with 24:1 low ratio; constant ratio power optional 17.51:1 ratio

Transmission	Fully synchronized 4-speed manual floor shift standard; column mounted automatic transmission with lock-up torque converter available on CJ-7 with Six or V-8. New automatic transmission available with 4-cylinder engine on CJ-7.
Tires	Five H78-15 black side wall polyester highway (unbelted) standard (See tire options)
Wheels	Five 15 x 5.5-bolt, 5.5" circle standard; optional wheels include 15 x 8 spoked steel 5-bolt on a 5.5" circle

CJ Engine Availability

Engine	Carb.	Comp. Ratio	Bore & Stroke	Avail.
151 CID Four	2-bbl.	8.2:1	4.00" x 3.00"	std.
258 CID Six	2-bbl.	8.3:1	3.75" x 3.90"	opt.
304 CID V-8*	2-bbl.	8.4:1	3.75" x 3.44"	opt.

* Not available in California.

EPA Mileage

27 Hwy. Est. MPG, **22** EPA Est. MPG (4-CYL)

24 Hwy. Est. MPG, **17** EPA Est. MPG (6-CYL)

Use these figures for comparison. Your results may differ due to driving speed, weather conditions and trip length. Actual highway mileage will be less. California figures were not available at time of publication. Consult your Jeep Dealer.



Jeep CJ

Drive one of our legends.



Jeep Cherokee



Jeep Pickup



Jeep Wagoneer



Jeep Corporation is a subsidiary of American Motors Corporation