



the world's most versatile vehicle

**LAND-  
-ROVER**





**L**AND-ROVERS have now completed fifteen years uninterrupted operation on and off the roads of the world. During this time they have built up a record of unremitting service that can never be equalled, while their numberless activities in undeveloped territories have become legendary. Ruggedly built and powerful, Land-Rovers will outlast any similar type of vehicle, their strong box-section chassis and alloy bodywork being proof against the ravages of rough and tumble operation in all weathers and climates. There is no substitute for the four-wheel drive Land-Rover, the world's most versatile vehicle.



LAND-  
-ROVER

**THE GREATEST  
NAME IN  
4-WHEEL DRIVE  
VEHICLES**



The Regular Land-Rover is the go-anywhere "maid of all work" of the range. In standard trim it is provided with a completely weather-proof canvas hood and glass door windows, while among a variety of optional body extras are included a truck cab giving excellent all-round visibility, and a detachable hard-top. Side windows in hoods and hard-tops are supplied for export.



*Hard-top with side windows for export*



*Regular with truck cab and three-quarter length hood*



*The detachable hard-top*



*Regular with truck cab*

## THE REGULAR LAND-ROVER

In its open form with canvas hood removed the Regular is a compact all-purpose, go-anywhere vehicle.





## THE LAND-ROVER REGULAR STATION WAGON



As an alternative passenger or goods-carrying vehicle the seven-seater Land-Rover Regular Station Wagon has tremendous appeal in territories where tough and exacting conditions are likely to be met. As a personnel carrier it will accommodate three people in front and four on fold-away seats in the rear compartment. With the seats folded up, ample body space is available for the transport of goods and equipment of all kinds.

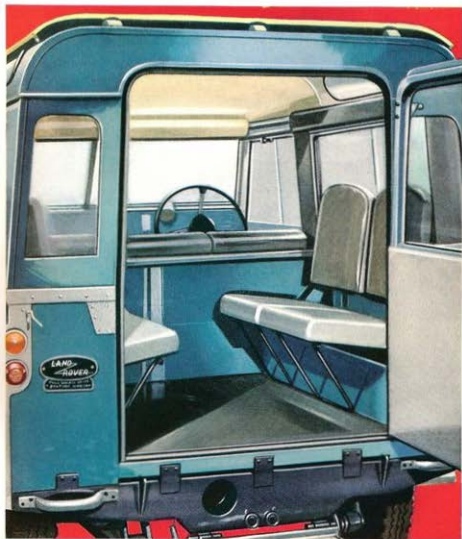

*The body is easily accessible from the rear of the vehicle*



*Nearside wing mirror optional extra*



*Three-quarter length hood with side windows  
for export*



*Full length canvas hood*

## THE LONG LAND-ROVER



*Three-quarter length hood*



Of greater carrying capacity than the Regular but having the same cross-country mobility and versatility is the Long Land-Rover. For off-the-road work a load of 1,800 lb. can be carried in the capacious body in addition to the driver and two passengers, while on journeys using more reasonable surfaces a payload of 2,000 lb. can be dealt with. All body covers are available with side windows for export.



*Long hard-top with side windows  
for export*



LAND-  
ROVER

The Long Land-Rover in standard open form is shown here. Various body covers are available as optional extras.





Based on the 109-inch wheelbase chassis the Long Station Wagon is a ten-seater, go-anywhere personnel carrier. The seating arrangement provides accommodation for three people in front, three on the back seat and four, facing inward, on additional seats fitted to the rear wheel boxes. If the wheel box seats are folded up and the back seat is lowered right forward the whole body is available for load carrying.



## **THE LAND-ROVER LONG STATION WAGON**



Like all Land-Rovers the Long Station Wagon has four-wheel drive, and affords an ideal means of carrying personnel or equipment over difficult country.





*Wide-opening doors at the side of the vehicle give excellent access to the interior.*

*Six-passenger accommodation at the back, accessible through the rear door or side doors.*



*Tip-up seats allow passengers to reach the rear compartment through the side doors when desired.*

## **12-SEATER LAND-ROVER**

The four-wheel drive Twelve-Seater Land-Rover is an immensely strong and powerful go-anywhere vehicle that completely solves the problem of transporting personnel to normally inaccessible places. It has seating for three people in front, three on individual tip-up seats behind, and six on inward-facing seats at the rear. Easy access to all the passenger accommodation is afforded by five doors, two on either side of the vehicle and one at the back.

As a personnel carrier, the Twelve-Seater Land-Rover is not subject to United Kingdom Purchase Tax and represents outstanding value for money.



## FORWARD CONTROL LAND-ROVER



*A very comfortable two-seater cab is provided.  
Heater and passenger-side windscreen wiper extra.*

The Forward Control Land-Rover has been designed to combine the accepted Land-Rover four-wheel drive mobility and toughness with a carrying capacity up to twice that of the Long model. It will deal easily with a 30-cwt. payload on roads and tracks and with 25-cwt. across rough country. Its high ground clearance and excellent weight distribution make it ideal for cross-country travel. It has the same speed range as the Long Land-Rover, can climb a 1 in 2 slope fully laden and has a side tipping angle of over 40 degrees.

Although unlike other Land-Rover models in appearance, the Forward Control vehicle uses a very high percentage of standard Land-Rover parts, a fact of great significance to fleet owners. Various body styles are available.



*Truck-cab with fixed-side body and  
three-quarter length hood.*



*Truck cab with flat platform body.*

LAND-  
ROVER

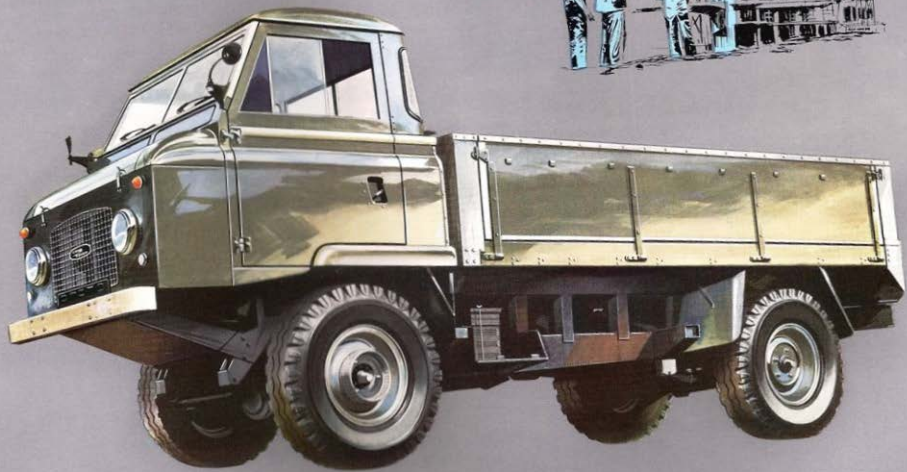

LAND  
-ROVER

## SENSIBLY DESIGNED BODY FEATURES

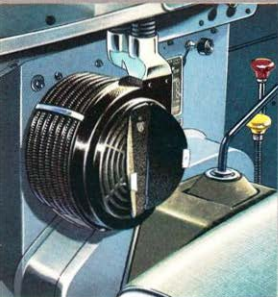

A heater of the recirculatory type can be supplied as an optional extra. Fitting neatly under the dash it will operate efficiently and give ample warmth in even the coldest weather. Attachments provide for windscreen defrosting.



The centrally mounted instruments may be read at a glance, while open compartments on either side of the panel offer very useful storage space for small items. Under the windscreen, two panels which can be opened or closed at will provide for controlled fresh-air ventilation.





Excellent accommodation for three people is provided in the driving compartment of all Land-Rovers. It is completely weather-proof, dust- and draught-free. Deep cushions give an exceptional degree of riding comfort, the driver's seat being adjustable fore and aft on Long models. A de-luxe cab, which is optionally available in Long Land-Rovers, has trimmed door casings and carpets as additional refinements.

The windscreen may be folded forward out of the way when not required.



Seating for four people can be fitted on the wheel boxes as an optional extra. The spare wheel is normally secured in the body but a special bonnet with spare wheel mounting can be supplied at extra cost if additional body space is required.

*This is the 109-inch Long chassis with 2½ litre petrol engine*

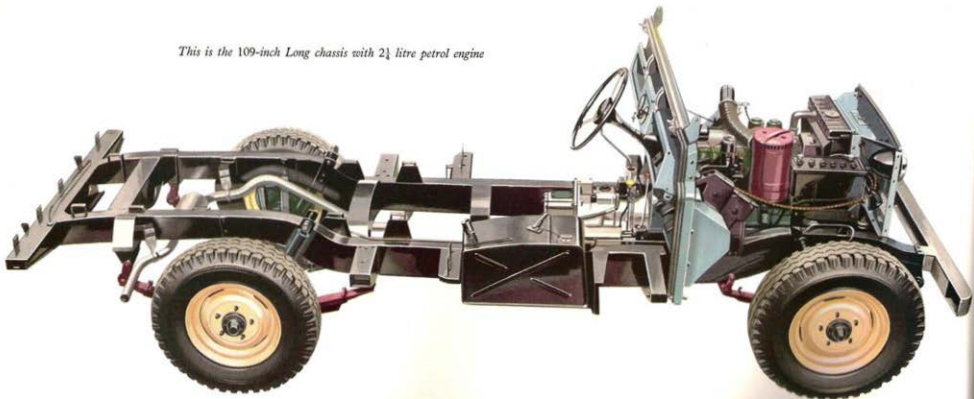

**LAND-  
-ROVER**

## **RUGGED CHASSIS CONSTRUCTION**

Of great strength and rigid box-section construction, the Land-Rover chassis will stand up to any strain or stress occasioned by the vehicle's go-anywhere, do-anything duties. During the dipping process, paint flows throughout the inside of the frame as well as over its outside surface to give maximum resistance to corrosion. The whole unit is of straightforward design affording exceptional ease of maintenance.

## SAFE STOPPING POWER

Land-Rovers are fitted with powerful hydraulic brakes, two leading shoes being used on Long models. The pendant pedal requires only light pressure, and a mechanically actuated handbrake operates on the transmission shaft to the rear axle.

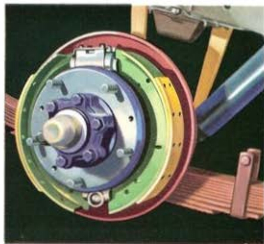

## STRENGTH AND STABILITY

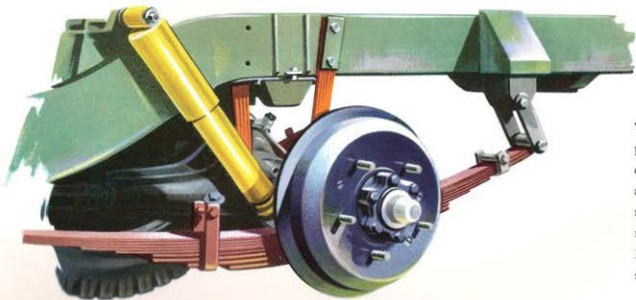

The suspension system gives immense stability and provides an extremely well-balanced ride for driver, passenger and load. Land-Rover springs are specially graded to combine the riding qualities required for normal road work with ample toughness for hard work over rough ground. On the Long Land-Rover rear springs are mounted on sturdy outtrigger brackets.

# DIESEL POWER FOR LONG RANGE ECONOMY

The 2½-litre diesel engine of Rover design and construction gives further versatility to the Land-Rover by increasing its efficiency and economy in conditions favouring diesel operation. A truly rugged, four-cylinder unit, the Rover diesel engine develops 62 h.p. at 4,000 r.p.m., while the maximum torque of 103 lb. ft. is developed at 1,800 r.p.m. Its speed range is sufficiently close to that of the Land-Rover petrol engine to enable the same transmission units to be used. Copper-lead main and big-end bearings are fitted for long-lasting reliability.

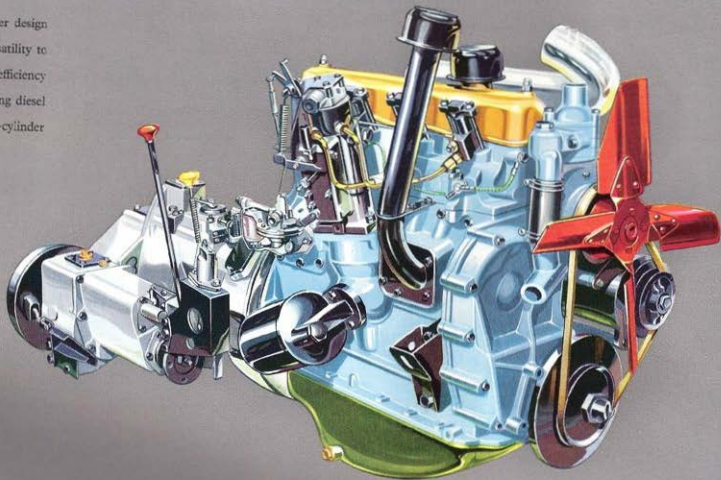

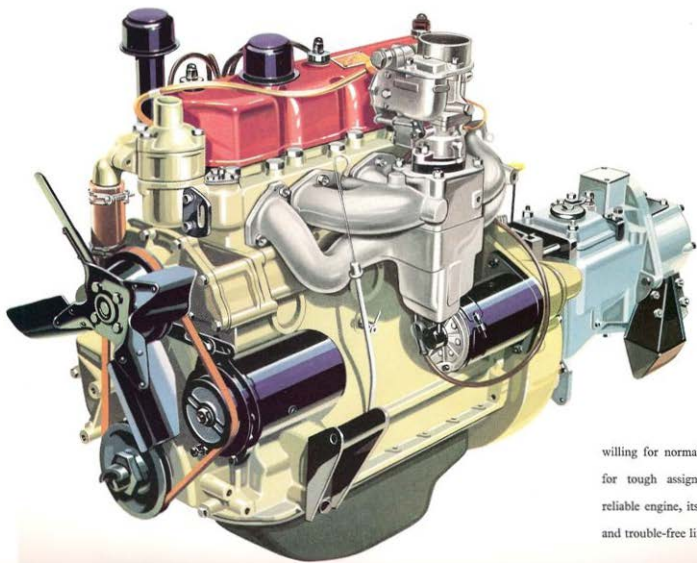

LAND  
-ROVER

The 2.1-litre overhead valve petrol engine develops 77 b.h.p. at 4,250 r.p.m. and has a torque of 124 lb. ft. at 2,500 r.p.m. Thus, there is abundant power available for vehicle operation, hauling trailers or driving machinery.

Power that is smooth and willing for normal work; slogging, determined power for tough assignments. This is an outstandingly reliable engine, its robust construction giving it a long and trouble-free life.

PETROL **POWER** TO GO ANYWHERE



## VERSATILE TRANSMISSION

This well-known, operationally-proved gearbox and transfer box unit is used in all Land-Rover models. The main gearbox has four forward speeds and one reverse, with synchromesh on third and top. Additional ratios are provided by the transfer box so that in all, eight forward and two reverse speeds are available. Selected as necessary with the two- or four-wheel drive they give to the Land-Rover its remarkable go-anywhere qualities.

In addition to the normal gear control, a yellow-knobbed, push-down lever selects two- or four-wheel drive in the high ratio range. The lever with red top engages low ratio with four-wheel drive.

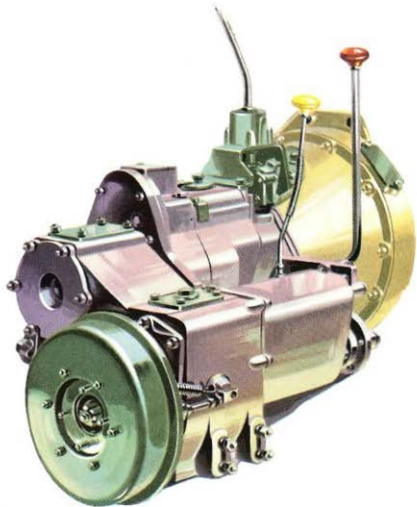

*Rear power take-off with splined shaft drive*



*Rear power take-off with pulley drive*



*Centre power take-off with vee pulley*



*Front-mounted hydraulic winch*

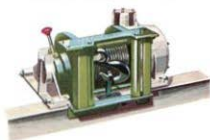

## **PRACTICAL POWER TAKE-OFF**

Land-Rover versatility is greatly enhanced by the provision of power take-off facilities. The equipment can be supplied at extra cost and enables various kinds of towed and standing machinery to be driven. There are four main types of power take-off unit: Rear, with splined shaft or pulley drive; centre, with pulley drive; front-mounted winch.



*Front-mounted capstan winch*



LAND  
-ROVER

# S P E C I F I C A T I O N

## Petrol Engine

**GENERAL.** Four cylinders. Overhead inlet and exhaust valves. Bore 90.49 mm. (3.526 in.), stroke 88.9 mm. (3.5 in.), capacity 2286 c.c. (139.5 cu. in.). Maximum b.h.p. 77 at 4,250 r.p.m. Maximum torque 124 lb. ft. (17 m.Kg.) at 2,500 r.p.m. Compression ratio 7 : 1.

**Cylinders :** Monobloc, cast integral with crankcase.

**Cylinder Head :** Detachable, cast iron and carrying all valve gear.

**Crankshaft :** Forged steel three bearing. Fully balanced and with counterweights.

**Main Bearings :** Three, thin shell, steel-backed copper-lead. Thrust taken at centre bearing.

**Camshaft :** Forged steel. Four bearings, steel-backed white metal lined. Drive by Duplex roller chain. Chain tension maintained by self-adjusting jockey sprocket, controlled by coil compression spring and oil pressure.

**Pistons :** Low expansion aluminium alloy, tin plated. Two compression rings and one scraper ring. Fully floating gudgeon pins.

**Valves :** Exhaust: En.54 steel, Stellite tipped and faced. Inlet: Silchrome No. 1 Steel.

**Connecting Rods :** Forged steel with thin shell steel-backed copper-lead big-end bearings.

**LUBRICATION SYSTEM.** By submerged gear type pump driven from camshaft. Oil delivered to main, big-end and camshaft bearings under a running pressure of 55-65 lb./sq. in. Oil is pressure fed to the camshaft bearings, exhaust and inlet valve gear in the head. Gauge pump intake filter in the sump: removable full-flow external oil filter.

**Oil Filler :** Incorporating oil-wetted gauze crankcase breather. Similar breather fitted to valve rocker cover.

**Sump Capacity :** 11 pints (6 litres). Level determined by dipstick.

**COOLING SYSTEM.** Pump operated and thermostat controlled. Water gallery cast in block directs flow to the points of highest temperature. Pressurised.

**Pump :** Centrifugal type, belt driven, mounted on front end of cylinder block.

**Radiator :** Fin and tube type.

**Fan :** Four bladed, mounted on water pump spindle. The Forward Control model has the fan mounted in a bearing housing on the sub-frame and is driven by an extension shaft from the water pump spindle. Belt tensioned by pivot mounted dynamo.

**Thermostat :** By-pass type.

**Capacity of System :** Regular and Long, 17½ pints (9.95 litres). Forward Control, 18 pints, (10.25 litres).

**FUEL SYSTEM :** Separate induction manifold.

**Carburettor :** Solex downdraught.

**Fuel Pump :** Mechanical.

**Air Cleaner and Silencer :** Large capacity oil bath type, with built-in centrifugal pre-cleaner.

**Petrol Tank :** Carried outside side-member under right-hand seat and fitted with protective underplate. On Long Station Wagon and Forward Control the petrol tank is located between the side-members behind the rear axle. Electric petrol gauge fitted.

**Filler :** Telescopic side filler tube and filter to facilitate filling from can.

**Tank Capacity :** 10 gallons (45 litres). 16 gallons (73 litres) on Long Station Wagon, 12-Seater and Forward Control.

**IGNITION SYSTEM :** Coil ignition. Lucas 12 volt, 57 amp. hr.

**Distributor :** Driven from camshaft. Automatic advance and vacuum control.

**Sparking Plugs :** Lodge long reach 14 mm.

**ENGINE UNIT MOUNTING.** Flexibly mounted on bonded rubber at four points, two at front of crankcase and two on transfer box.

## Diesel Engine

**GENERAL.** Four cylinders. Overhead inlet and exhaust valves. Bore and stroke: 3.562 in. x 3.5 in. (90.99 mm. x 88.9 mm.). Cubic capacity: 2286 c.c. (139.5 cu. in.). B.H.P. (max.): 62 at 4,000 r.p.m. Torque (max.): 103 lb. ft. at 1,800 r.p.m. Compression ratio: 23 : 1.

**Cylinders :** Monobloc, cast integral with crankcase.

**Cylinder Head :** Detachable, cast iron, carrying all valve gear.

**Valve Operation :** By rockers, solid push rods and roller cam followers.

**Crankshaft :** Forged steel. Fully balanced and with counterweights.

**Main Bearings :** Three, thin shell, steel-backed, copper-lead. Thrust taken at centre bearing.

**Camshaft :** Forged steel. Four bearings of wrap round white metal on steel backing. Drive by Duplex roller chain. Chain tension maintained by self-adjusting jockey sprocket, controlled by coil compression spring and oil pressure.

**Tappets :** Chilled cast iron rollers running in lead tin-plated bronze shoes.

**Pistons :** Low expansion aluminium alloy, tin plated. One parallel faced chrome compression ring. Two taper faced iron compression rings. One slotted scraper ring. Fully floating gudgeon pins.

**Valves :** Exhaust: En.54 steel, Stellite tipped. Inlet: Silchrome No. 1 Steel.

**Connecting Rods :** Forged steel with thin shell steel-backed copper-lead big-end bearings.

**LUBRICATION.** By submerged gear type pump driven from camshaft. Oil delivered to main, big-end and camshaft bearings and to tappet gallery under a running pressure of 50-60 lb./sq. in. Rocker shaft and rockers lubricated by pressure feed from the camshaft bearing oil gallery. Gauge pump intake filter in the sump: removable full-flow external oil filter.



**Oil Filler :** Tube from front camshaft housing side cover plate incorporating oil-wetted breather. Similar breather fitted to valve rocker cover.

**Sump Capacity :** 11 pints (6 litres). Level determined by dipstick.

**COOLING SYSTEM.** Pump operated and by-pass thermostat controlled. Water gallery cast on the side of the cylinder block directs water between the bores, it is then routed up to the head, where it passes round injector and combustion chamber bosses. From here the water flows through tube inserts which direct it between the valve portings. Pressurised.

**Pump :** Centrifugal type, belt driven, mounted on front end of cylinder block.

**Radiator :** Fin and tube type.

**Fan :** Four bladed, mounted on water pump spindle. Belt tensioned by pivot mounted dynamo.

**Thermostat :** By-pass type.

**Capacity of System :** 17 pints (9.75 litres).

**INDUCTION SYSTEM.** Separate induction manifold.

**AIR CLEANER and SILENCER.** Large capacity oil bath type and integral centrifugal pre-cleaner.

## FUEL SYSTEM.

**Fuel Lift Pump :** Mechanical, driven off eccentric on camshaft.

**Fuel Filter :** C.A.V. Bowl-less paper element type, mounted on dash.

**Injection Pump :** C.A.V. DPA type with mechanical governor.

**Injector Nozzles :** Pintaux type.

**Glow Plugs for Cold Starting :** Operated by starter key.

**ENGINE UNIT MOUNTING.** Flexibly mounted on bonded rubber four points, two at front of crankcase and two on transfer box.

## Transmission

**CLUTCH.** Regular and Long: Multiple spring type—9 in. (0.23 m.). Single dry plate. Spring cushion drive. Forward Control: Diaphragm spring type—9 in. (0.24 m.). Single dry plate. Spring cushion drive. Fitted in enclosed bell housing in which is mounted clutch operating shaft and levers. Light operating pressure.

**Clutch Operation :** Pendant clutch pedal mounted on dash and operating hydraulically.

**Clutch Withdrawal Thrust :** Ball thrust race enclosed in special housing and fully lubricated.

**MAIN GEARBOX.** Four forward speeds, one reverse.

**Synchromesh :** Top and third gears.

**Gear Change :** By direct central ball change lever on top of gearbox on Regular and Long models and by remote control linkage on the Forward Control.

**Oil Capacity :** 2½ pints (1.5 litres).

**TRANSFER GEARBOX.** Giving a two-speed reduction on the output from the main gearbox and providing overall ratios as follows:

### Regular and Long :

Main Gearbox	Transfer box	
	High ratio	Low ratio
First gear ... ..	16.2	40.6
Second gear ... ..	11.0	27.7
Third gear ... ..	7.4	18.7
Top gear ... ..	5.4	13.6
Reverse gear ... ..	13.7	34.6

### Forward Control :

Main Gearbox	Transfer box	
	High ratio	Low ratio
First gear ... ..	25.9	49.4
Second gear ... ..	15.96	30.5
Third gear ... ..	10.86	20.7
Top gear ... ..	7.19	13.72
Reverse gear ... ..	21.7	41.4

**Transfer Gear Change :** By independent lever, also giving intermediate neutral position.

**Speedometer Drive Gear :** Incorporated with output shaft of transfer gearbox.

**Oil Capacity :** 4½ pints (2.5 litres).

**FOUR-WHEEL DRIVE.** Automatically selected when transfer box low ratio is engaged. Drive to front axle optional with high ratio engaged. Selected by an independent control.

**POWER TAKE-OFF.** Centre and rear power take-off drives available as optional extras on Regular and Long, except Station Wagons. Forward Control can only be fitted with centre power take-off.

**MAXIMUM DRAW-BAR PULL.** (Dependent on surface conditions.)

Regular	{ Petrol ... ..	4,000 lb. (1800 kg.)
	{ Diesel ... ..	3,500 lb. (1497 kg.)
Long	{ Petrol ... ..	3,500 lb. (1600 kg.)
	{ Diesel ... ..	2,900 lb. (1315 kg.)
Forward Control	{ Petrol ... ..	3,920 lb. (1775 kg.)

**PROPELLER SHAFTS.** Hardy Spicer open propeller shafts to front and rear axles. Gaiter fitted to sliding coupling spline of front shaft.

**Lubrication :** By oil gun through nipples.

**REAR AXLE.** Fully-floating type. Spiral bevel drive in banjo type axle case.

**Ratio :** 4.7 : 1.

**Bevel Pinion Bearings :** Taper roller journal, pre-loaded.

**Hub Bearings :** Taper roller journal.

**Oil Capacity :** 3 pints (1.7 litres).

**FRONT AXLE.** Fully-floating type. Spiral bevel drive in banjo type axle case.

**Ratio :** 4.7 : 1.

**Bevel Pinion Bearings :** Taper roller journal, pre-loaded.

**Hub Bearings :** Taper roller journal.

**Angularity of Universal Joints at Full Lock :** 26°.

**Oil Capacity, Differential :** 3 pints (1.7 litres).

**Oil Capacity, Universal Joint Housing :** 1 pint (0.57 litres).

## Suspension

**Springs :** Semi-elliptic type, underslung. Rubber bushes all round. Second leaves wound round shackles pin eye to give extra strength.

**Shock-Absorbers :** Monromatic double-acting telescopic type front and rear.

LAND  
-ROVER

# S P E C I F I C A T I O N

## Steering

Burman worm and nut type with recirculating ball. Right- or left-hand steering as required.

**Ratio:** Regular and Long: 15.6 : 1 straight ahead, 23.8 : 1 on full lock. Forward Control: 19.6 : 1 straight ahead, 29.9 : 1 on full lock.

**Steering Wheel:** 17 in. (0.43 m.) diameter. Spring spokes.

**Relay Unit:** Consists of spring loaded Tufnol damping cones.

**Drag Link, Track Rod, and Longitudinal Tube:** Tubular, with non-adjustable ball joints requiring no lubrication.

**Turning Circle:** 88 in. wheelbase Regular with 6.00 x 16 tyres—38 ft. (11.6 m.) diameter, 109 in. wheelbase Long with 7.50 x 16 tyres—45 ft. (13.7 m.) diameter, Forward Control with 9.00 x 16 tyres—49 ft. (14.9 m.) diameter.

## Brakes

**Foot Brake:** Girling hydraulic. Servo assisted on Forward Control.

Regular—leading and trailing shoes all round. Size of brakes 10 in. x 1 1/2 in. (25.4 cm. x 3.8 cm.). Lining area 104.7 sq. in. (675.5 sq. cm.). Long—two leading shoes on front brakes, leading and trailing shoes on rear brakes. Size of brakes 11 in. x 2 1/2 in. (27.9 cm. x 5.7 cm.). Lining area 171.6 sq. in. (1111 sq. cm.). Forward Control—two leading shoes on front brakes, leading and trailing shoes on rear. Size of brakes 11 in. x 3 in. (27.9 cm. x 7.6 cm.) on front, 11 in. x 2 1/2 in. (27.9 cm. x 5.7 cm.) on rear. Lining area 200.6 sq. in. (1290 sq. cm.).

**Hand Brake:** Internal expanding transmission type on rear output shaft of transfer box. Girling mechanical, 9 in. x 1 1/2 in. (22.9 cm. x 4.4 cm.).

**Hand Brake Lever:** Extending forward from seat box and accessible to driver's hand.

**Stop Light Switch:** Operated hydraulically.

## Frame and Body

Welded fabricated box section side- and cross-members, providing great torsional and diagonal rigidity.

**Body Mounting:** Regular and Long, on outriggers welded to side-members. Forward Control, on body sub-frame.

**Bumper:** Bolted to front dumb irons. Channel section, heavily galvanized.

**Body:** All body panels are of non-corrodible light alloy, and all external steel fittings are heavily galvanized.

## Electrical Equipment

**Dynamo:** 12 volt Lucas. Fan ventilated. Compensated voltage control. Belt driven. Diesel models are fitted with current-voltage regulator.

**Battery:** Petrol Models—Lucas 12 v. 57 A.H. carried under bonnet on Regular and Long Models and located between the outrigger brackets on left-hand side member at rear of cab on Forward Control Models.

**Diesel Models—Lucas 6 v. 120 A.H.** One under bonnet and one under left-hand front seat, connected in series.

**Ignition Coil:** Lucas. Mounted on engine side of scuttle in Regular and Long, and on engine of Forward Control.

**Starter:** Petrol Models—Lucas M418G operated by a direct push switch situated below fascia on Regular and Long Models. The Forward Control starter is operated by a solenoid and the switch is located on the dash.

**Diesel Models—Lucas M45G.S.I.D.** with integral solenoid operated by combined heater/starter switch on dash.

## INSTRUMENTS AND CONTROLS.

**Speedometer:** Large diameter with total mileage recorder.

**Fuel Gauge and Ammeter:** Combined in one large dial which also includes the headlamp main beam warning light.

**Electric Horn:** Windtone. Horn push in centre of steering wheel.

**Electric Windscreen Wiper:** Mounted on lower edge of windscreen frame. Switch on motor.

**Panel Light:** Illuminating speedometer, ammeter and fuel gauge. Switch does not operate unless side and tail lamp switch is closed.

**Dip Switch:** Mounted on floor. Red warning lamp indicates main beam.

**Headlamps:** Mounted in radiator cowling. Twin filament light units for main and dipped beam.

**Side Lamps:** Mounted in front wings.

**Tail Lamps:** Twin units having double filament stop/tail bulbs and incorporating number plate illumination on Regular and Long Models. Forward Control has a separate number plate illumination lamp.

## Petrol Models:

**Ignition Switch:** Operated by key. Rotary switch for head, side and tail lamps.

**Ignition Warning Light:** Red.

**Choke Warning Light:** Amber.

**Oil Pressure Warning Light:** Green.

## Diesel Models:

**Electrical Services Switch:** Operated by key. Rotary switch for head, side and tail lamps.

**Heater/Starter Switch:** Operated by key.

**Engine Stop Control:** Fitted below dash.

**Charging Warning Light:** Red.

**Heater Plug Warning Light:** Amber.

**Oil Pressure Warning Light:** Green.

**Fuel Tank Level Warning Light:** Blue.

## Road Wheels

Detachable pressed steel disc easy-clean type with ventilation slots. Five wheel studs.

**Tyres:** Regular, basic equipment 6.00 x 16, dual purpose. Long, basic equipment 7.50 x 16, dual purpose. Forward Control, basic equipment 9.00 x 16, dual purpose.

## Tools

Full kit of hand tools in roll. Starting handle, wheelbrace, oil gun, jack.

LAND  
ROVER

# BODY SPECIFICATION

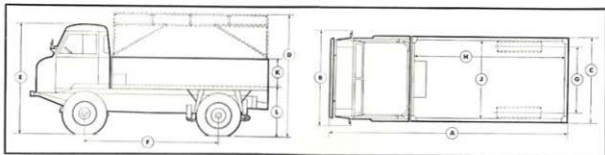

## FORWARD CONTROL

DIMENSIONS	English	Metric
Length overall ... (A)	193 in.	4.9 m.
Width overall (across mirrors) (B)	75½ in.	1.92 m.
Width of body ... (C)	68½ in.	1.74 m.
Height overall, with hood (unladen) ... (D)	102 in.	2.6 m.
Height of cab (unladen) ... (E)	80½ in.	2.25 m.
Wheelbase ... (F)	109 in.	2.77 m.
Track ... (G)	53 in.	1.36 m.
Body interior length ... (H)	123 in.	3.14 m.
Body interior width ... (I)	65 in.	1.61 m.
Height of body sides ... (K)	21 in.	540 mm.
Platform height (unladen) ... (L)	44 in.	1.12 m.
Ground clearance ... (M)	10 in.	254 mm.
Turning circle ... (N)	49 ft.	14.9 m.
Vehicle weight (standard vehicle with cab and body but without hood) in running trim with 5 gallons (22.5 litres) of petrol ...	4,305 lb.	1,948 kg.
Payload on road and track ...	3,380 lb.	1,532 kg.
Payload in the rough ...	2,800 lb.	1,270 kg.
Max. allowable gross weight on road	8,000 lb.	3,625 kg.
Max. allowable gross weight in the rough ...	7,440 lb.	3,374 kg.

## REGULAR and LONG

DIMENSIONS	English	Metric	English	Metric
Wheelbase ... (A)	88 in.	2.23 m.	109 in.	2.77 m.
Track ... (B)	51½ in.	1.31 m.	51 in.	1.31 m.
Ground Clearance ... (C)	8 in.	203 mm.	9½ in.	248 mm.
Turning Circle ... (D)	38 ft.	11.58 m.	45 ft.	13.72 m.
Overall Length ... (E)	142½ in.	3.62 m.	175 in.	4.44 m.
Overall Width ... (F)	64 in.	1.63 m.	64 in.	1.63 m.
Overall Height (max.) ... (G)	77½ in.	1.97 m.	81 in.	2.06 m.
Height of body sides ... (H)	19½ in.	495 mm.	19 in.	483 mm.
Body interior width between cuppings ... (I)	56½ in.	1.44 m.	56½ in.	1.44 m.
Floor width between wheel bolers ... (J)	36½ in.	921 mm.	36½ in.	921 mm.
Width of wheel bolers ... (K)	13½ in.	349 mm.	13½ in.	349 mm.
Body interior length between cuppings ... (L)	43 in.	1.09 m.	72½ in.	1.85 m.
Height of wheel bolers ... (M)	8½ in.	216 mm.	9 in.	229 mm.
Height, floor to roof (max.) (N)	48½ in.	1.23 m.	48 in.	1.22 m.
<b>PAYLOADS</b> (with standard tyres)				
On the road ...	3 persons + 1,000 lb. (450 kg.)		3 persons + 2,000 lb. (900 kg.)	
In the rough ...	3 persons + 800 lb. (365 kg.)		3 persons + 1,800 lb. (816 kg.)	
<b>WEIGHT</b>				
In running trim with 5 gall. (22.5 litres) of fuel:	lb.	kg.	lb.	kg.
Petrol Models ...	2,953	1,339	3,301	1,497
Diesel Models ...	3,097	1,404	3,471	1,574

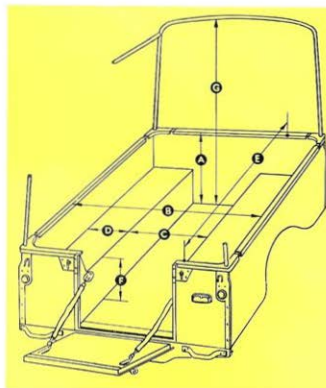

The Rover Company Limited reserves the right to alter specifications, colour, design or price without notice and without incurring any obligation. While every effort is made, in Rover literature, to provide information that is strictly up to date, no responsibility can be accepted for such alterations that occur after date of going to press. Persons dealing in the Company's goods are not the agents of the Company and have no authority whatsoever to bind the Company by any expressed or implied undertaking.

THE ROVER COMPANY LIMITED · SOLIHULL · WARWICKSHIRE · ENGLAND

Telephone: Sheldon 4242.

Telegrams: Rover, Solihull.

Service Depot: SOLIHULL.

Telegrams: Rovrepair, Solihull.

London Showrooms: DEVONSHIRE HOUSE, PICCADILLY, W.1.

Telephone: GROsvenor 3252.

London Service Depot: SEAGRAVE ROAD, FULHAM, S.W.6. Telephone: FULham 1221. Telegrams: Rovrepair Wespnone, London.



By appointment to Her Majesty Queen Elizabeth II  
Manufacturers of Motor Cars and Land-Rovers  
The Rover Company Limited

THE WORLD'S MOST VERSATILE VEHICLE

**LAND** →  
← **ROVER**