

# VOYAGER

## PLYMOUTH



PATTERSON - CHRYSLER - PLYMOUTH  
JEEP - EAGLE  
1965 N. Ellsworth Ave.  
Salem, Ohio 44460  
216-337-3475



# P L Y M O U T H

## Safety is Voyager's most important feature

Your car should help protect you wherever you go. Plymouths do. We've received numerous letters from owners across the country attesting to the fact that our safety features help save lives.

**Unibelt lap/shoulder restraints**, standard, protect all front and rear outboard passengers. A low-tension retractor keeps passengers comfortable while belted and a new design latch plate makes buckling up easier than ever.

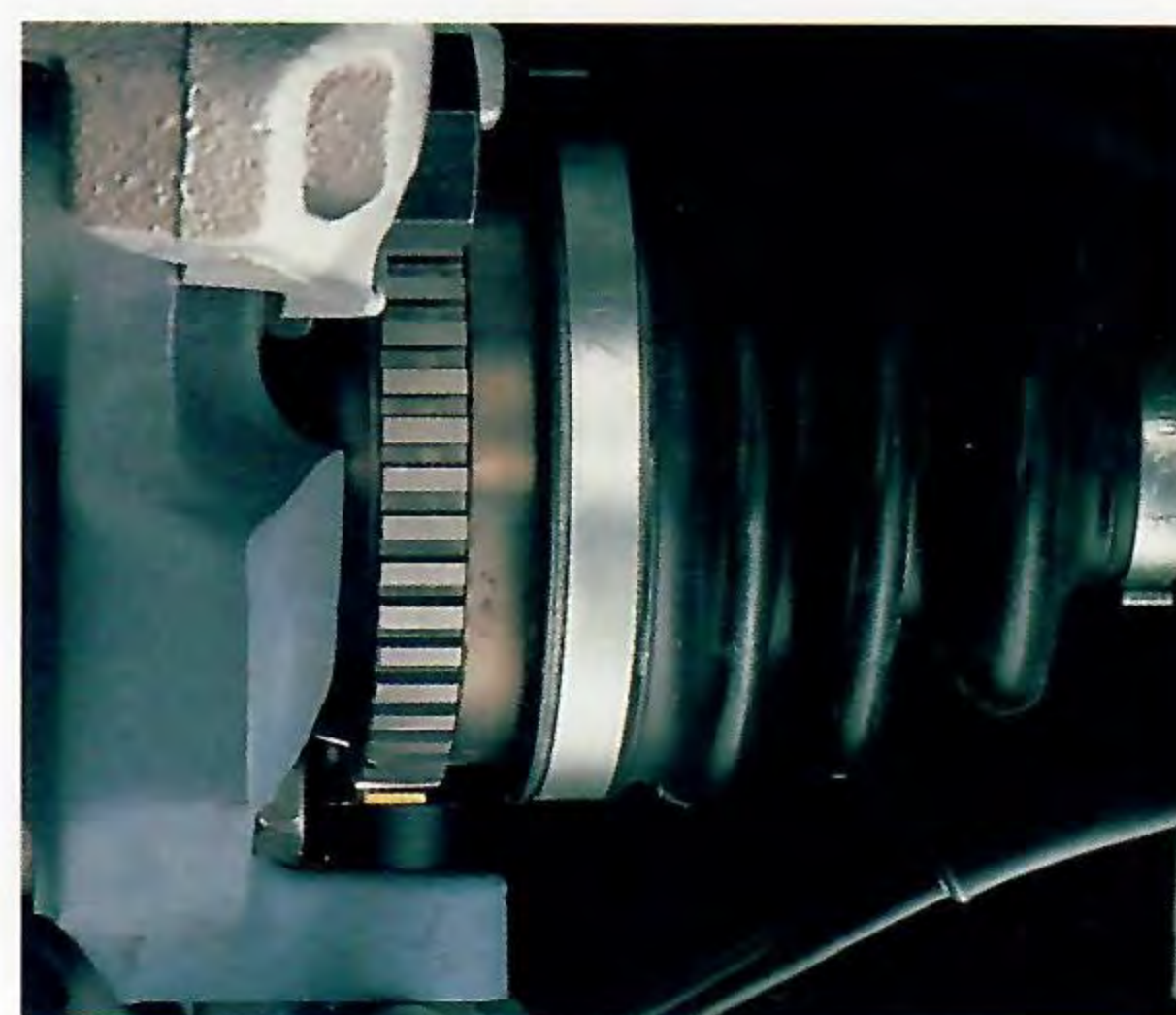

**Four-wheel antilock brakes\*** option improves driver steering and vehicle stability during hard braking.

**All-wheel drive** option offers the safety of full-time traction-sensing for sure-footed traction and handling on wet, slippery or snow-covered roads.



**Child Guard protective lock**, on Voyager's sliding side door, standard, keeps kids safe.



\*December availability on AWD models

**Power door locks** option allows secure locking of all vehicle doors from the driver's seat. (Standard on LE models.) (Automatic actuation as vehicle reaches 15 mph.)

**New center high-mounted stoplight**, standard, in base of rear window, improves brake light visibility.

**Mobile cellular phone** option offers call-from-your-car security. (Dealer-installed. See page 29 for additional information.)



**Advantage: Plymouth Safety.**



## The best just got better new Plymouth Voyager

**About this catalog.** We have tried to make this catalog as complete as possible. However, since the time of printing, some of the information you'll find here may have been updated. Your dealer has details, and you should ask him for current information before ordering.

Some of the equipment shown or described throughout this catalog is available at extra cost.

Voyager LE with LX Decor Package, shown right in Dark Quartz Gray Clear Coat.





**P**lymouth Voyager has been a leader ever since it created the mini van market. Now there's the new 1991 Voyager, with shapely aerostyling, a standard automatic transaxle, available V6 power, and a totally redesigned interior.

Voyager's new, optional four-wheel anti-lock brakes\* and all-wheel drive are not available on the 1991 Chevy Lumina APV. Advantage: Plymouth. We improved and refined the new Voyager to create a new definition of family transportation for the 90s.



# V O Y A G E R



# G R A N D V O Y A G E R L E

***Plymouth's largest  
Voyager is big on  
V6 power and comfort***

**T**he ultimate mini van. The top-of-the-line Plymouth Grand Voyager LE is fully loaded with standard amenities, including a 3.3-liter MPI V6, power-assisted steering and brakes, air conditioning, electronic speed control, tilt wheel, dual power remote control heated rearview mirrors, full tinted glass, power rear quarter

vent windows, seven-passenger seating, power door locks, AM/FM stereo radio with integral digital clock, and much more. Measure interior volume and you'll find Grand Voyager more spacious than the 1991 GM APVs. Advantage: Plymouth. Grand Voyager is shown below in Claret Red Pearl Coat.


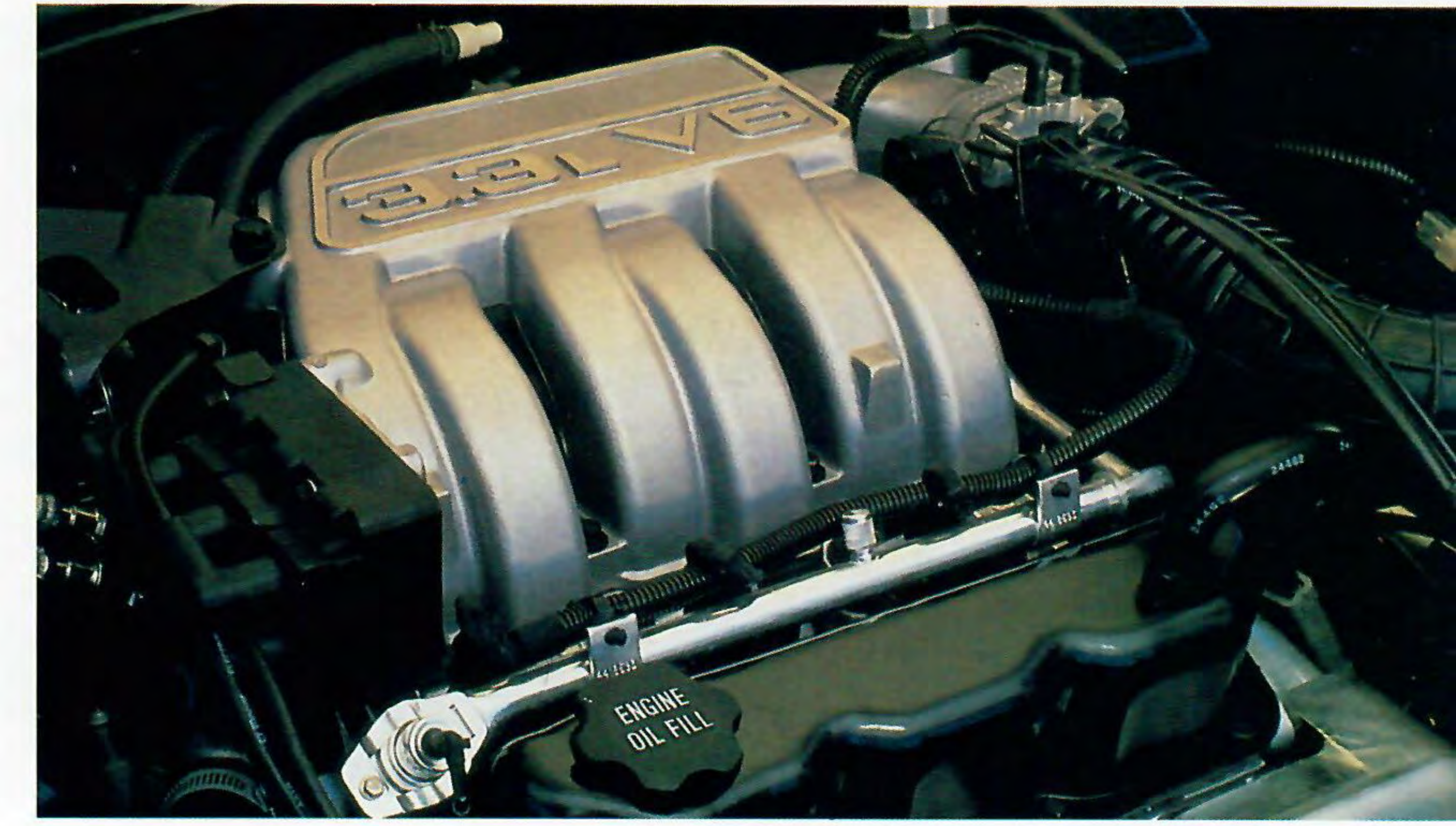



# Q U A D

***Voyager's bucket seats  
part of an all-new  
totally redesigned  
interior***

**T**otal comfort. The Voyager LE's new, optional Quad Command Seating Package offers contoured, space-efficient low-back reclining bucket seats in front and center positions, with a walk-through aisle to the three-passenger rear bench. All bucket seats, shown right and below



# C O M M A N D

in Champagne, feature adjustable lumbar supports and head restraints. Plymouth Voyager virtually invented the concept of seating flexibility, with movable and removable rear seating that can be easily reconfigured to your seating and cargo-hauling requirements (shown right).

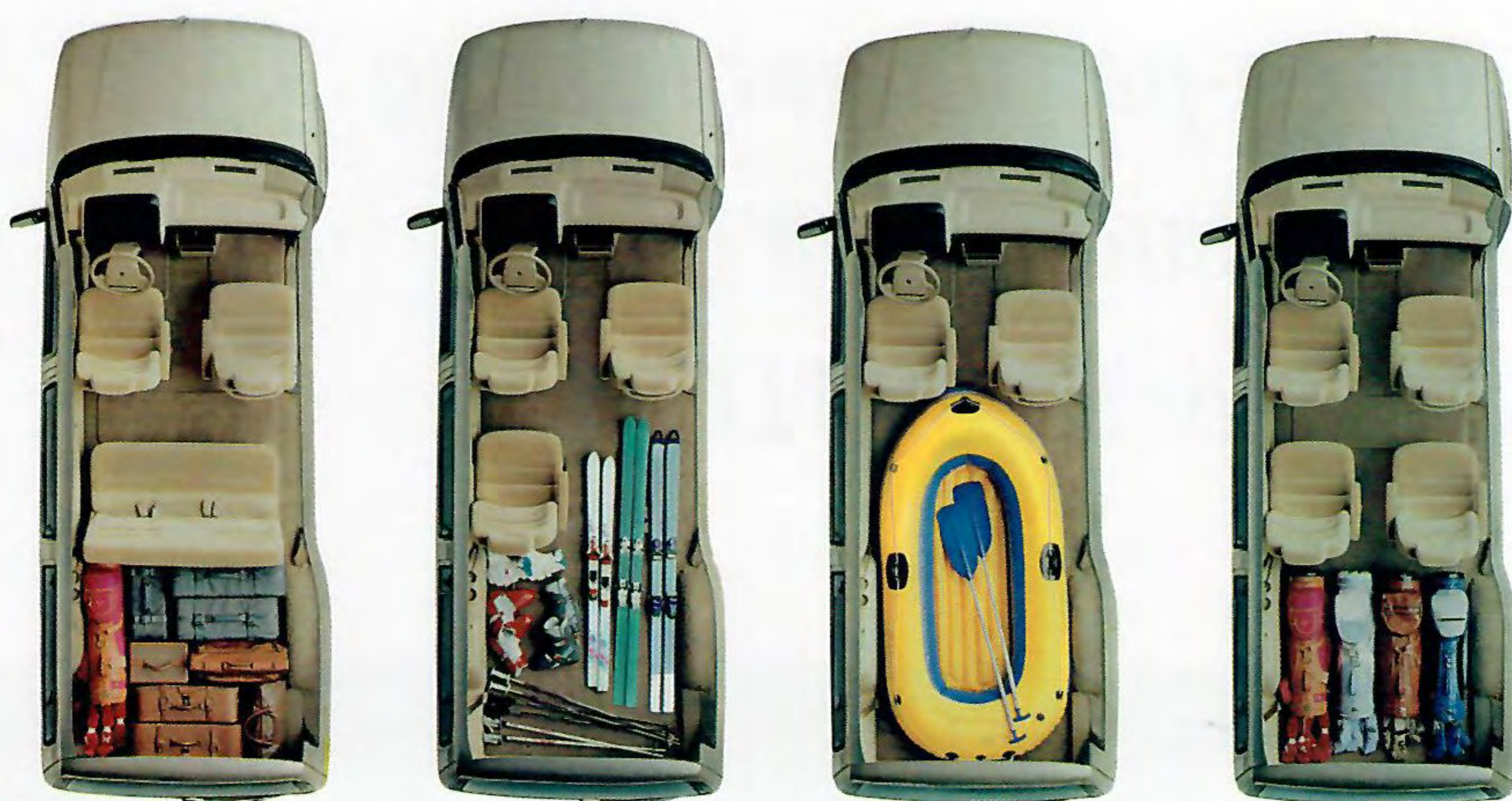



# V O Y A G E R

## ***Seven-passenger seating now standard on Voyager SE and LE***

**T**he spacious comfort of true, seven-passenger seating is standard equipment on Voyager SE and LE models. These rich chair-high, cloth with vinyl trim seats support you wonderfully during long

# S E A T I N G

drives. You can also choose the elegance and luxury of available leather-with-vinyl trimmed seats. (On LE models only.) Grand Voyager LE seven-passenger seating is shown below in Champagne.





# V O Y A G E R

*Voyager's new interior blends ergonomics and thoughtful conveniences*

Voyager's all-new interior includes a naturally contoured instrument panel that clusters gauges and switches for excellent readability and control. There's also a new standard glove box and an available console (shown right) with cubby box, large storage bin with cassette rack, cup holders and more.



Voyager LE instrument panel shown above.



# VOYAGER ALL-WHEEL-DRIVE LE

*Voyager offers new all-wheel drive to take on the world*

Plymouth Voyager's sophisticated new all-wheel drive delivers excellent cornering, plus full-time traction-sensing for sure-footed driving on wet, slippery or snow-covered roads. The Plymouth Voyager's innovative All-Wheel-Drive System features full-time traction sensing that directs 90 percent of the engine's torque to the front wheels during normal driving. When the front wheels



slip, a viscous coupling automatically sends torque to the rear wheels. The more slip, the more torque is transferred to those wheels with the best traction. It's a system that's not available on GM's APVs. Advantage: Plymouth. AWD Grand Voyager LE, shown below in Black Cherry Pearl Coat.





# V O Y A G E R

***Voyager SE is a value leader with standard automatic transaxle and seven-passenger seating***

**L**oaded with value and standard features, Voyager SE, shown below in optional Diamond Blue/Twilight Blue two-tone, has a 2.5-liter SOHC EFI engine and three-speed automatic transaxle; with front-wheel drive that's not available on the 1991 Aerostar or Astro. Power steering and brakes, front side window demisters, tinted glass, inside power liftgate release, dual

power remote control outside mirrors, AM/FM stereo, and liftgate wiper/washer are also standard. It's one low step up through Voyager's easy-sliding side door (shown right) with a new Child Guard door lock and new inside handles for easy operation. Voyager SE is also available with the comfort of four high-back bucket seats in the Quad Command Seating Package.

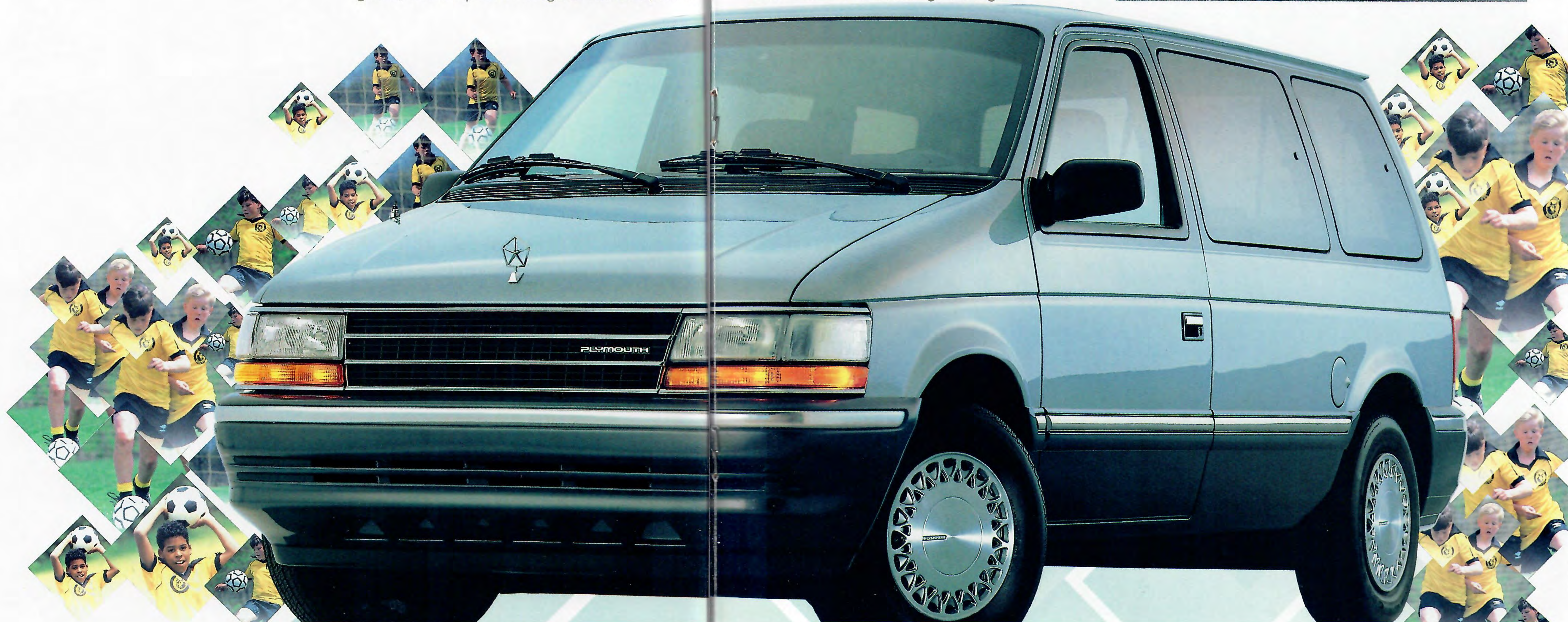



# F E A T U R E S



**Side storage bin** beside the left middle seat provides a handy place for loose items. **Handy cup holders** keep drinks upright and are located next to the left center seat and on the left rear wheelhousing on models with seven-passenger seating (not shown).



**The handy, new glove box** is standard on all Voyagers. A locking underseat storage drawer is now standard on LE models, available on SE.



**A handy side storage bin with armrest lid and cup holders** is located next to the rear seat on the left rear wheelhousing.



Standard **dual power sideview mirrors** are now hinged, folding either forward or back, to help avoid damage. Heated mirrors are standard on Voyager LE, available on SE.



**Child Guard door locks** on Voyager's sliding side door keep kids safe and new inside handles offer easier door operation.

**Liftgate wiper/washer** (shown below) is standard on all Voyagers and has fixed/intermittent movement with larger wiper pattern; new arm-mounted five-jet washer cleans new larger rear glass area more effectively. **Wide rear liftgate** has a new easy-to-use outside lift handle and new larger gas-charged props for ease of operation.



**Center and rear quarter panel windows** flip open for quiet, flow-through fresh air ventilation. The Plymouth Voyager is shown below in Platinum Silver Metallic Clear Coat.





# O P T I O N S



**Overhead console** (standard on Voyager LE, available on SE models) with mini trip computer that includes readouts for compass, outside temperature, trip odometer, miles per gallon, miles until empty in U.S. or Metric values, and trip elapsed time. Plus front and rear map/reading lights; separate sunglasses and garage door opener storage; and controls for the available **power-operated rear vent windows**.



**Four-wheel antilock brakes** improve braking stability by electronically modulating brake pressure for improved driver steering control during hard braking. (Available on SE and LE models. Late availability on AWD models.)

**Rear heater/air conditioner\*** provides additional comfort for rear passengers. Features controls on the instrument panel and on left side trim panel next to middle seat (not shown) (available for Grand Voyager SE and LE only).

**Roof luggage rack** holds your excess baggage atop the vehicle.† (Not available on All-Wheel-Drive models.)

**Sunscreen glass** is dark tinted to provide privacy and prevent solar heat buildup.



**Mobile cellular phone** features hands-free operation, super speed dialing, automatic radio mute, 100-number memory, auto power off timer, and much more. See page 29 for additional information.

**Front header map/reading lights** are mounted above the center of the windshield to illuminate the front seat area when needed (available as part of the Light Package).

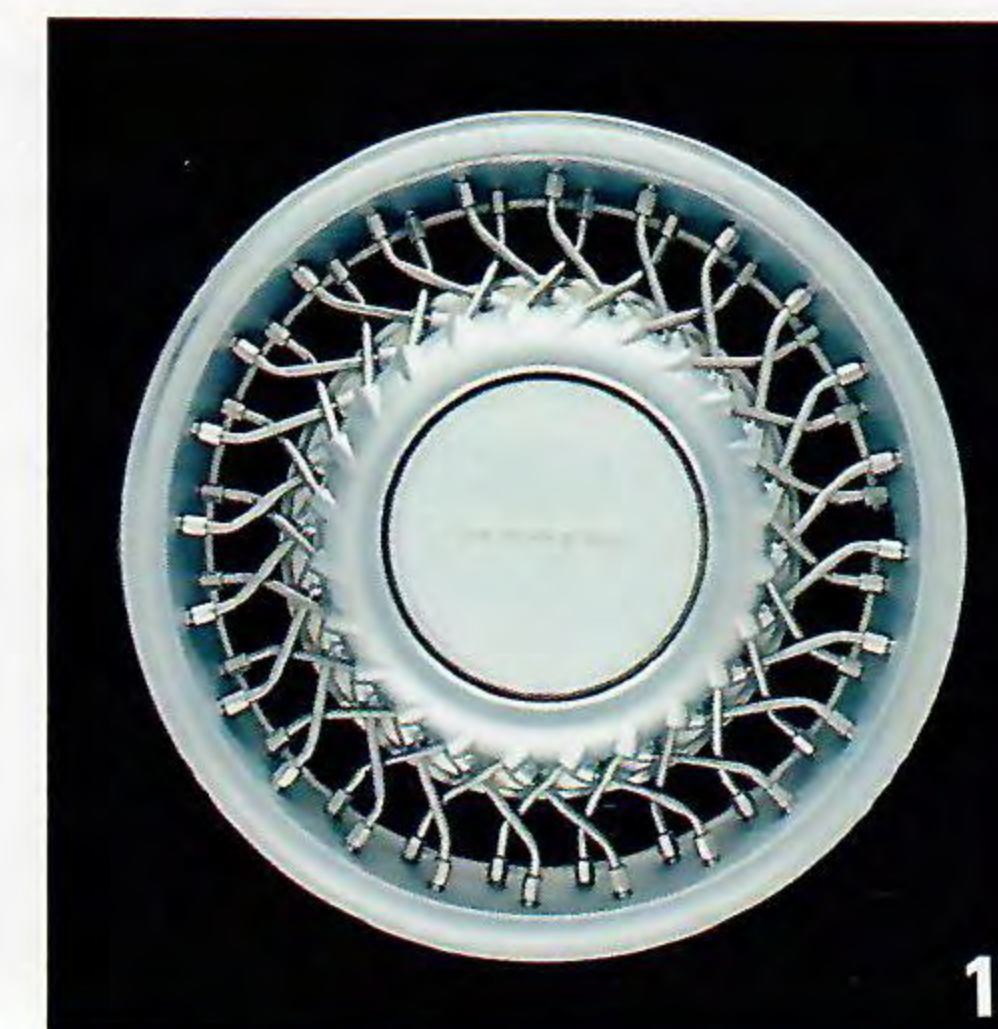

**Wheel covers and road wheels** enhance Voyager's appearance. Choices include: (1) 14-inch wire wheels with security locks; (2) Luxury wheel covers; (3) 15-inch cast aluminum road wheels.

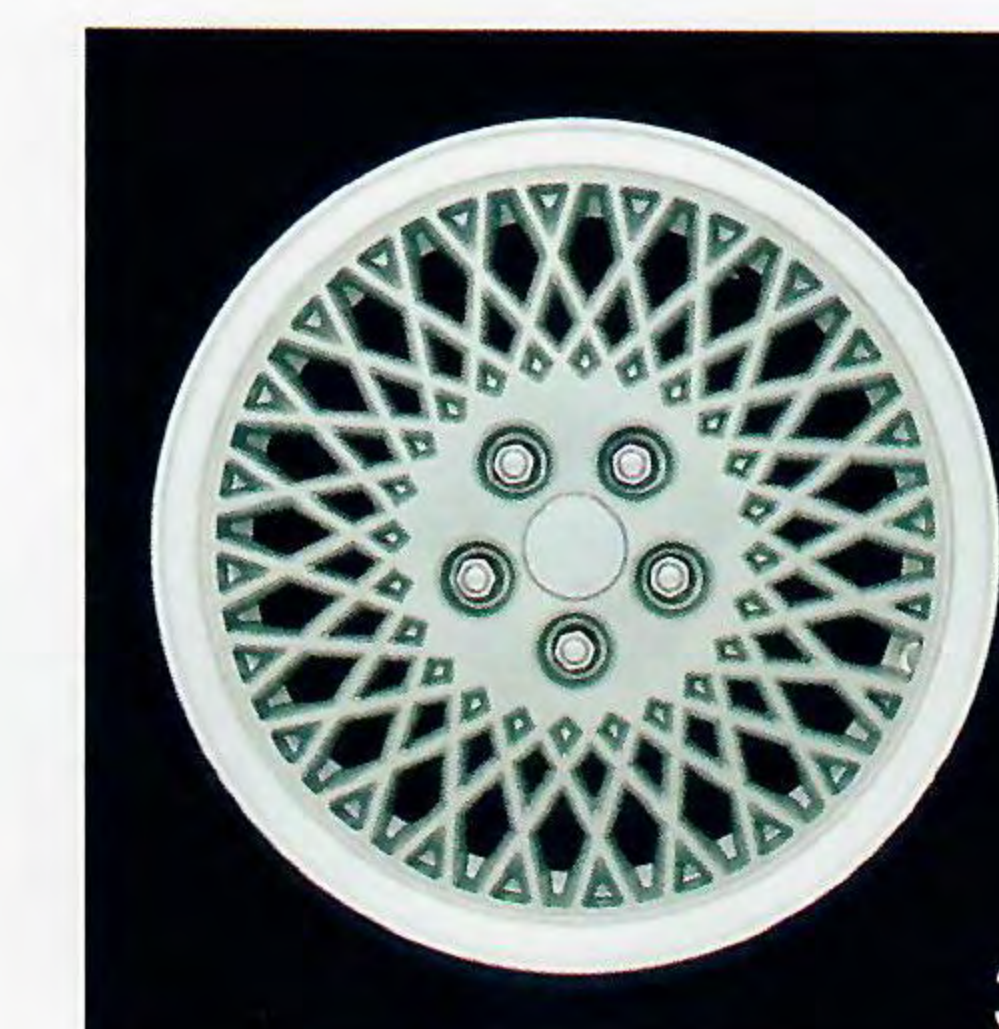

**Leather-with-vinyl-trim low-back reclining front bucket and rear bench seats** offer luxury and comfort. (Available on LE, Grand LE and LE All-Wheel-Drive models with Luxury Value Package.)



**Chrysler Infinity I Sound System.** AM stereo<sup>‡</sup>/FM stereo radio/cassette sound system includes electronic tuning, seek-and-scan and Dynamic Noise Reduction<sup>§</sup>, cassette tape player with automatic reverse and Dolby B Noise Reduction<sup>¶</sup>, ten specially tuned Infinity speakers, and an integral digital clock. (Available on all Voyager and Grand Voyager SE and LE models.)

\*There are special engine cooling requirements for field-installed air conditioning. Failure to follow these requirements may invalidate warranty. See your dealer for details.

†Does not increase vehicle's maximum load capacity.

‡Some AM stereo broadcasting may not be compatible with this system.

§Dynamic Noise Reduction is a trademark of National Semiconductor Corporation.

¶Dolby B is a trademark of Dolby Laboratories.



Plymouth Voyager, shown left in Diamond Blue Clear Coat.



# ENGINEERING

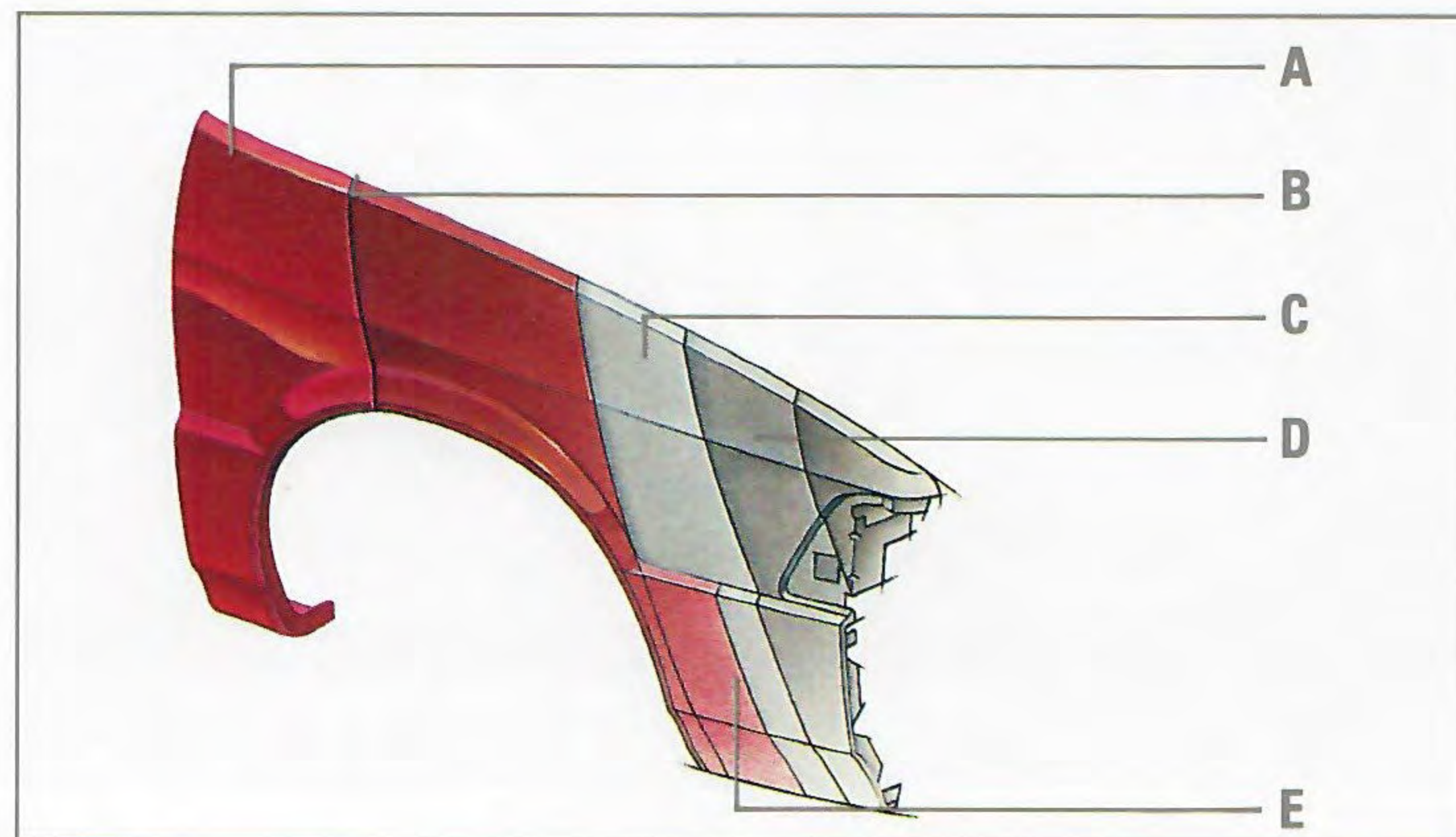

## 1 Corrosion Protection.

- A. Zinc-iron alloy-coated steel is zinc-phosphated as part of a nine-step pre-treatment which cleans and prepares the metal surface.
- B. In a full immersion process, the entire body is coated with a corrosion-resistant epoxy electrocoat primer.
- C. An anti-chip coating protects the lower bodyside against stone damage.
- D. A two-stage base color coat is applied.
- E. Two coats of clear are applied wet-on-wet over the base coat for an environmentally resistant mirror finish. (All body panels, except roof, exposed to corrosives are two-side galvanized/galvannealed.) (See page 29 for 7/100 Anticorrosion Limited Warranty.)

**2 Dual-path Iso-Strut gas-pressurized front suspension** has been redesigned to improve handling and "feel." **New Sport Handling Package** is available on front-wheel-drive SE and LE models and includes a rear sway bar, heavy-duty brakes, P205/70R15 all-season tires on 15-inch wheels and Luxury wheel covers.

**3 Power-assisted rack-and-pinion steering** delivers low turning effort and car-like handling.

**4 Voyager's new vehicle body computer** offers advanced microprocessor control of a variety of electronic vehicle features including: automatic power door locks option and interlock feature, warning chimes and lights, instrument cluster, optional mini trip computer, message center warning lamps, illuminated entry system, liftgate interlock, sliding side door memory lock, windshield wiper/washer control, and more.

**5 A new front door latch mechanism** is quieter, and works smoothly, with less operating effort.

**6 New seat recliners** offer continuously adjustable reclining adjustment mechanism...new high-quality dual latch driver's seat track adjustment is stable, smooth and easy-operating. **7 New seat latch anchor mechanisms** are now relocated at the rear of the seat along with lighter-weight seat frames for easier seat removal and replacement.

**8 New quieter exhaust system** is supported by new rubber isolators. A rear resonator has been added to the 2.5-liter engine; a triple-pass rear muffler added to the existing front muffler on front-drive V6 models; and with all-wheel drive, a large front muffler and rear resonator are used.

**9 All-Wheel Drive.** Voyager's new system is traction-sensitive for excellent control on poor driving surfaces.

**10 Voyagers equipped** with the computer-controlled 3.3-liter MPI V6 also receive Chrysler's electronically controlled four-speed overdrive transaxle (available with 3.0L\* V6 on SE and LE models).

**11 New optional four-wheel antilock brakes<sup>†</sup>** modulate braking to maintain steering control during braking. **Power-assisted brakes** come standard on every Voyager with front disc, self-adjusting rear drum system and a load-sensing proportioning valve for smooth braking under varying load conditions.

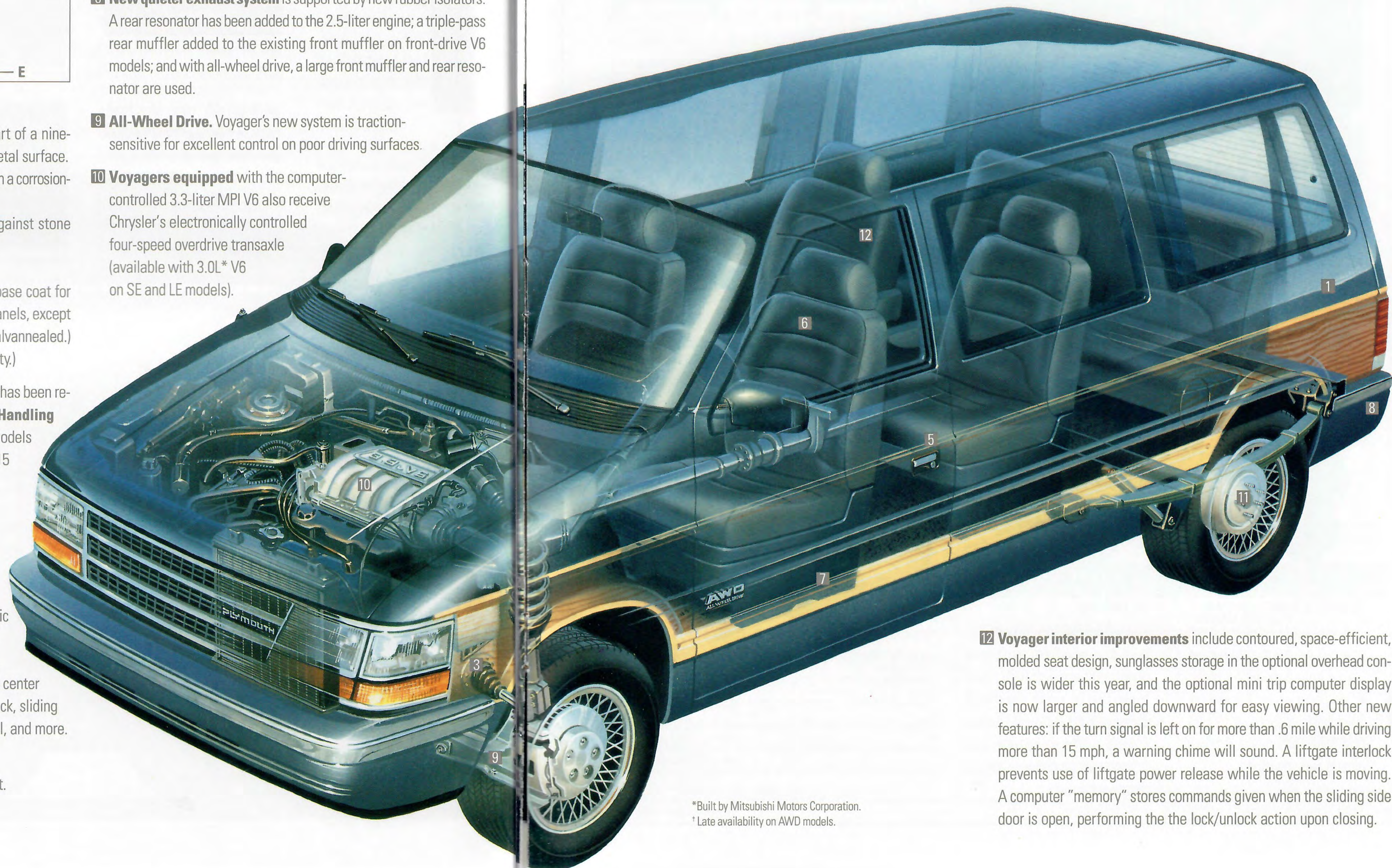

**12 Voyager interior improvements** include contoured, space-efficient, molded seat design, sunglasses storage in the optional overhead console is wider this year, and the optional mini trip computer display is now larger and angled downward for easy viewing. Other new features: if the turn signal is left on for more than .6 mile while driving more than 15 mph, a warning chime will sound. A liftgate interlock prevents use of liftgate power release while the vehicle is moving. A computer "memory" stores commands given when the sliding side door is open, performing the the lock/unlock action upon closing.

\*Built by Mitsubishi Motors Corporation.  
<sup>†</sup> Late availability on AWD models.





## New features make 1991 our safest Voyager ever

For 1991, we made the new Plymouth Voyager safer, with new outboard **intermediate and rear seat Unibelt lap and shoulder restraints** as standard equipment. A low-tension retractor keeps passengers comfortable while belted and a new design buckle and latch plate makes buckling up easier than ever. A **Child Guard lock** on the sliding side door is also standard for 1991. Flip the small lever on the latch to disable the inside door handle for the safety of your little ones. Voyager's sliding side door also features new, ergonomic inside handles that make opening and closing easier. The added safety of new, optional **four-wheel anti-lock brakes\*** helps improve stability and maintain driver steering control during hard braking. And a new **center high-mounted stoplight** in the base of the rear window (not shown) improves brake light visibility.

\*Late availability on AWD models.

## ENGINES

## Advanced Voyager engines for excellent performance

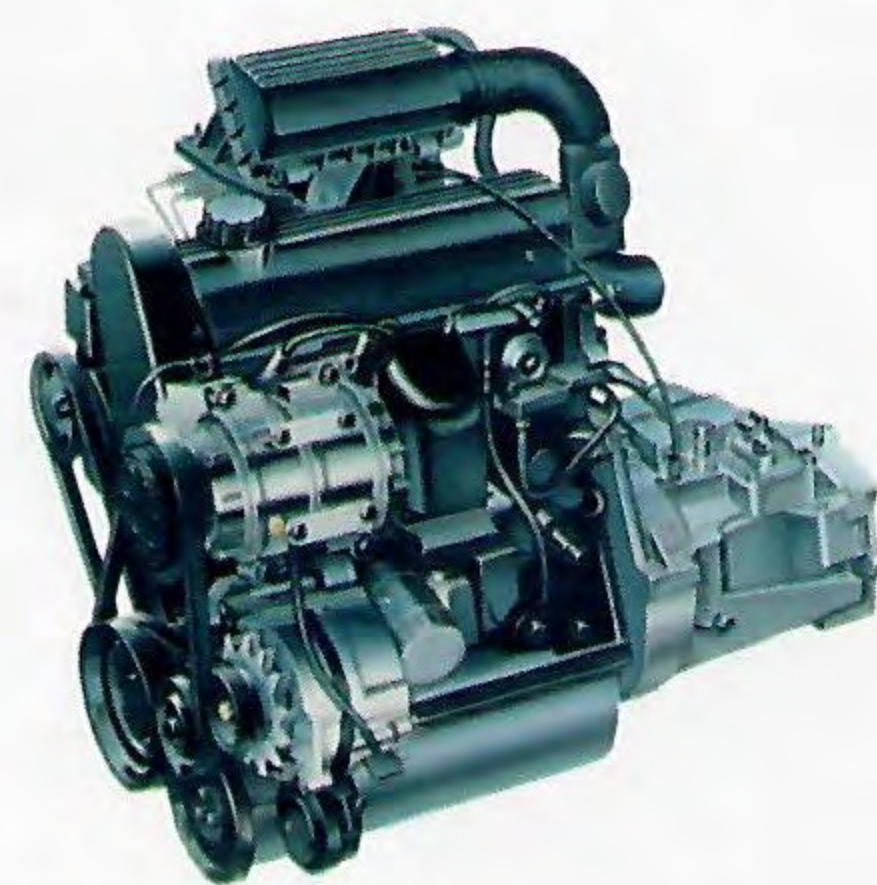

### THE 2.5-LITER EFI BALANCE-SHAFT ENGINE

The 2.5-liter EFI balance-shaft engine delivers impressive torque output, powerful acceleration, and efficient operation. Twin balance shafts and Quiet Idle features ensure smooth engine performance.

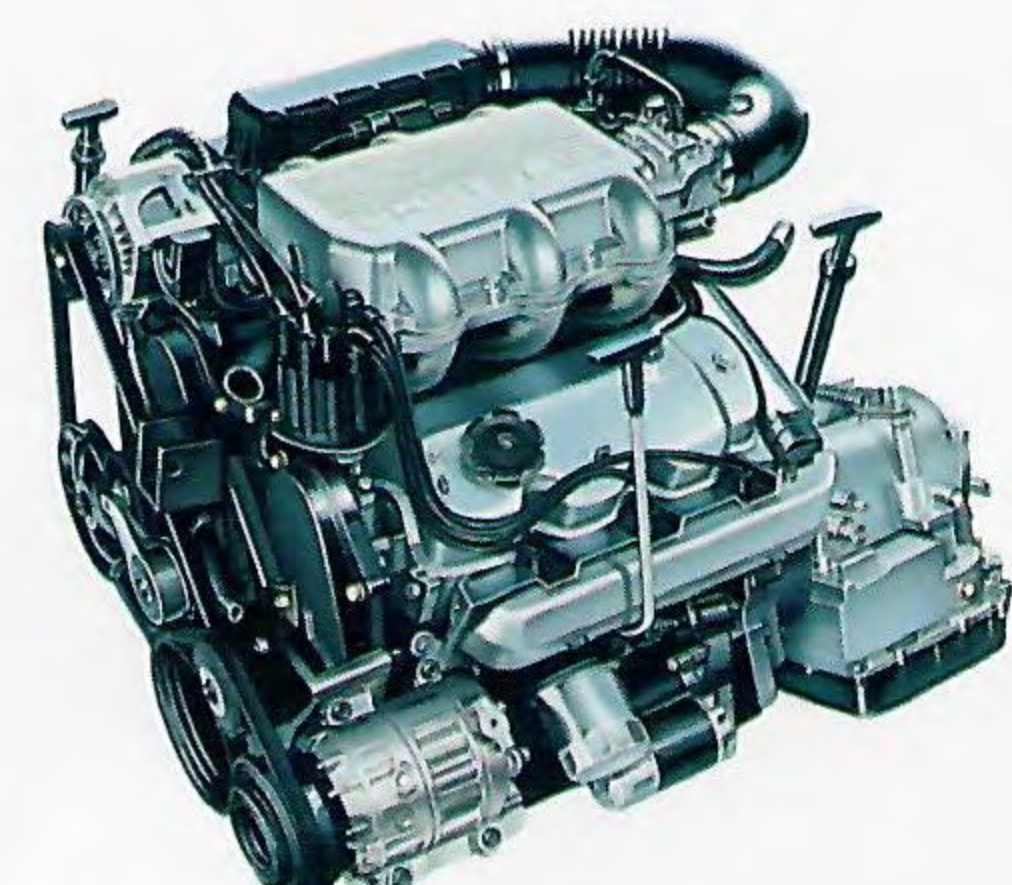

### THE 3.0-LITER OHC MPI V6 ENGINE

The 3.0-liter V6 MPI Mitsubishi-built engine offers excellent power and acceleration. Electronic fuel injection, overhead camshafts and dual tuned intake manifolds offer smooth idle and uniform throttle response across the power curve.

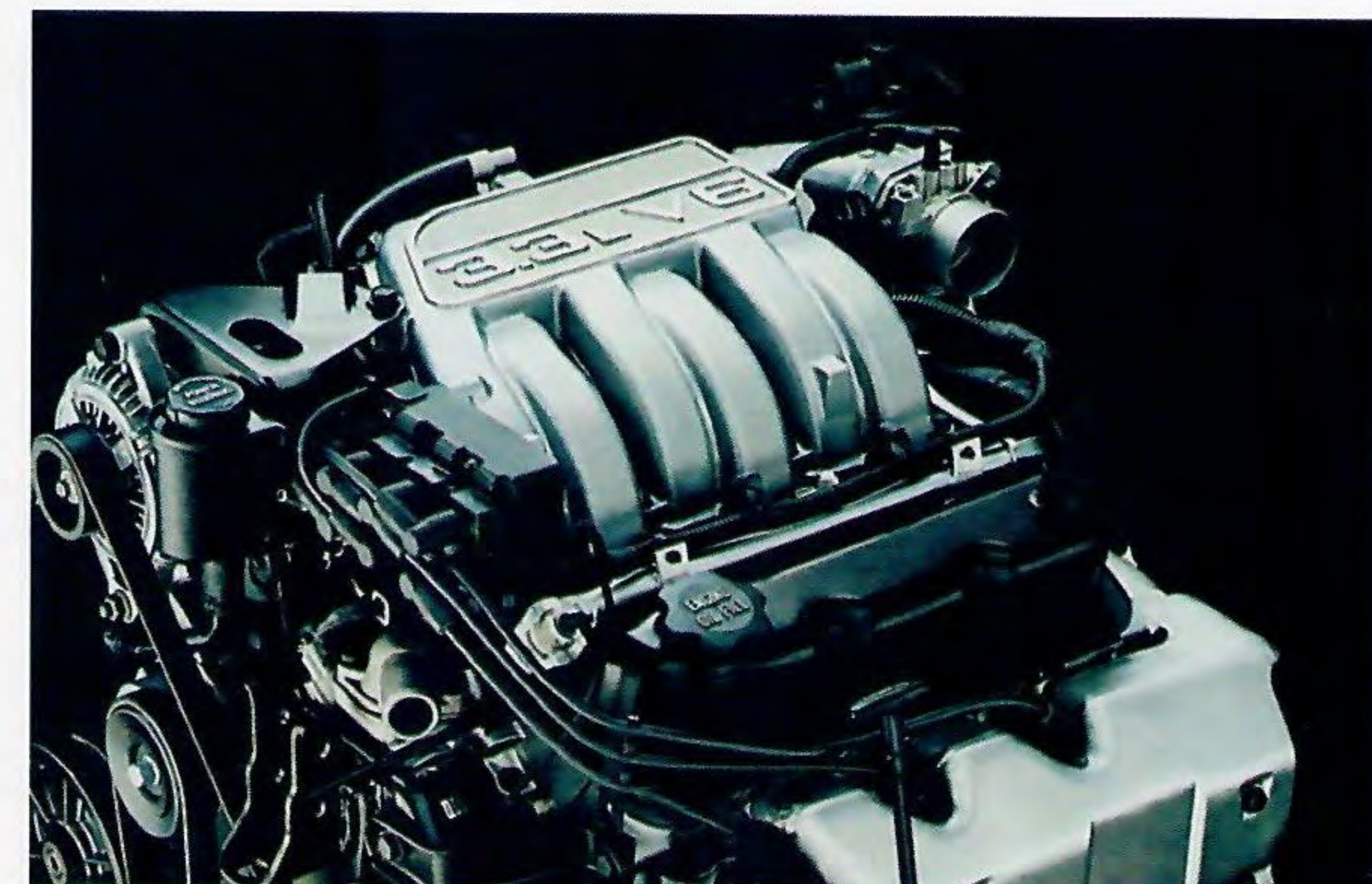

**3.3-LITER V6 MPI ENGINE** This powerful 3.3-liter V6 includes multipoint electronic fuel injection, tuned intake manifold, and a high-efficiency computer-controlled distributorless ignition system for quick acceleration and smooth idling. It generates 150 horsepower at 4,800 rpm and 185 pound-feet of torque at 3,600 rpm. (Note: See power train chart on page 25 for engine availability.)

## VOYAGER DIMENSIONS

## VOYAGER

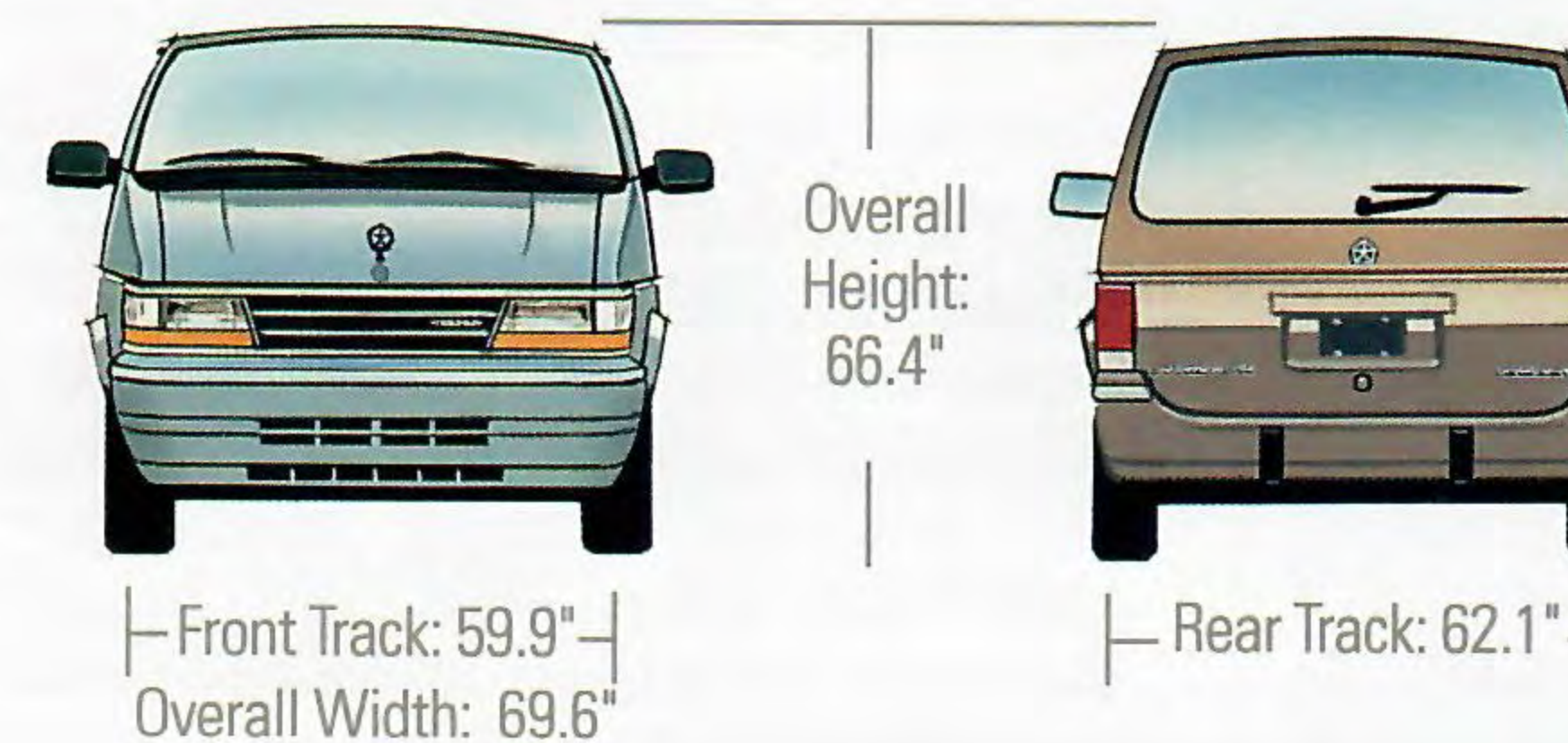
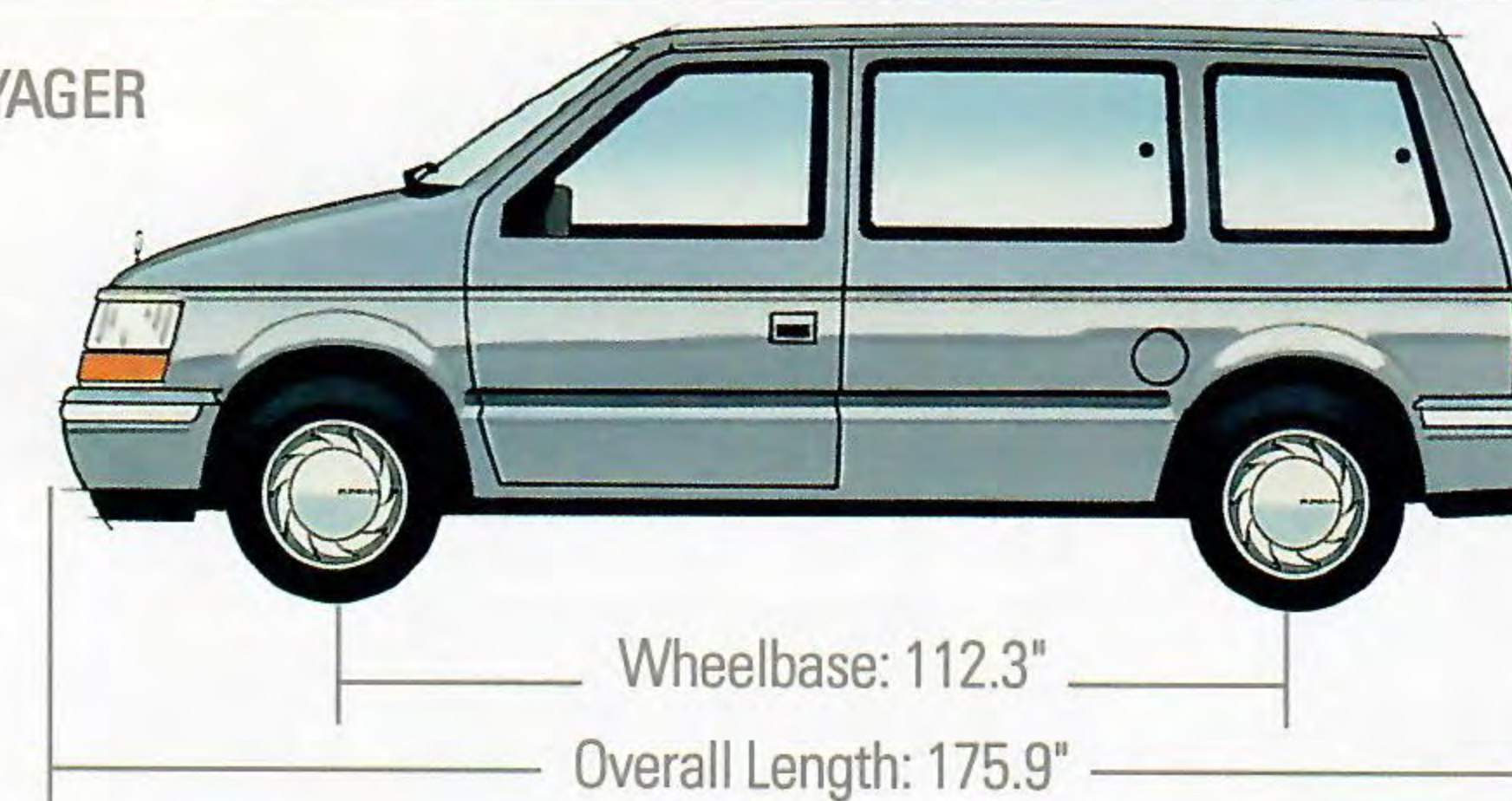

## GRAND VOYAGER

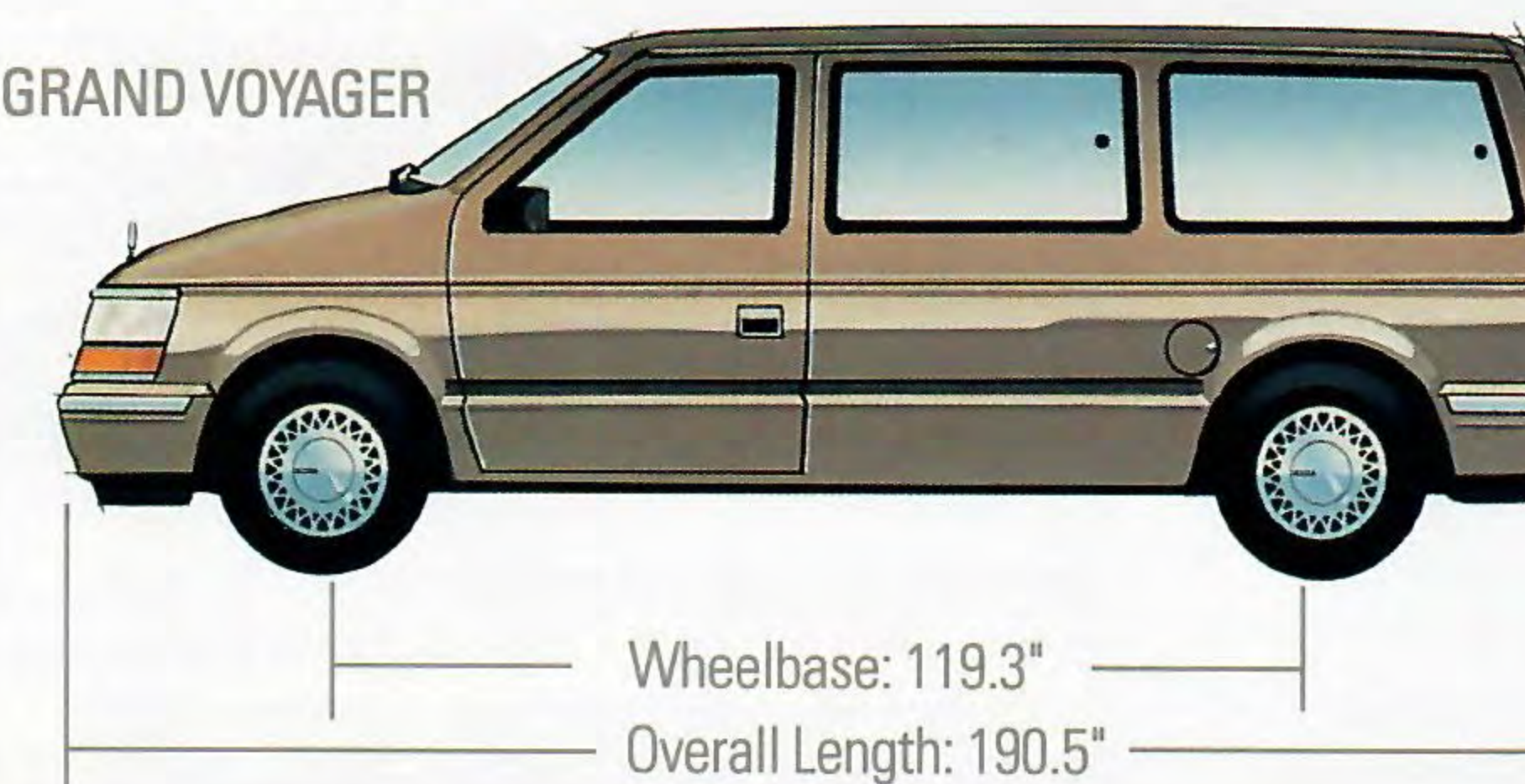

## SPECIFICATIONS

	VOYAGER, VOYAGER SE/LE/AWD	GRAND VOYAGER SE/LE/AWD
LENGTH—Cargo compartment at floor	82.6	97.1
WIDTH—Cargo compartment between wheelhousings	48.3	48.3
CARGO VOLUME		
Five-passenger seating	53.9	81.4
Seven-passenger seating	13.3	25.6
Rear seats removed	115.9	139.4

## MILEAGE

21 EPA est. city mpg, 25 EPA est. hwy. mpg\*

\*Mileage figures based on base model standard engine with 3-speed automatic transmission.

POWER TRAIN CHART<sup>1</sup>

	VOYAGER					GRAND VOYAGER			
	BASE	SE	SE AWD	LE	LE AWD	SE	SE AWD	LE	LE AWD
2.5-liter with three-speed automatic	S	S	NA	S	NA	NA	NA	NA	NA
3.0-liter <sup>2</sup> with three-speed automatic	O	O	NA	NA	NA	NA	NA	NA	NA
3.0-liter <sup>2</sup> with four-speed automatic	NA	O	NA	O	NA	NA	NA	NA	NA
3.3-liter with four-speed automatic	NA	O	S	O	S	S	S	S	S

S—Standard. O—Optionally available. NA—Not available.

<sup>1</sup>California emissions controls and testing required at extra cost on all vehicles registered in California; not available otherwise.

<sup>2</sup>Built by Mitsubishi Motors Corporation.

## TOWING APPLICATIONS

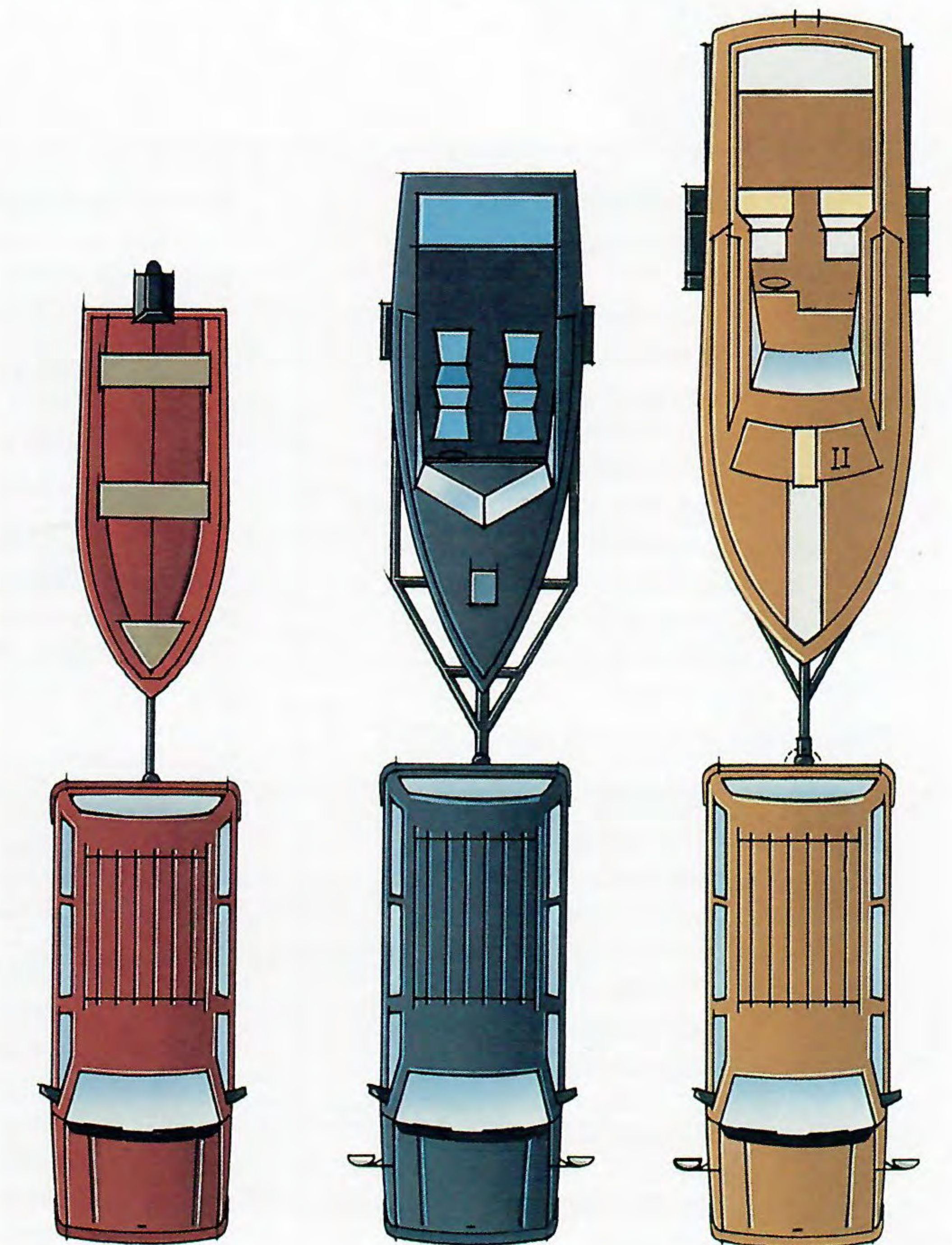

### All Voyager models with 2.5-liter EFI engine.

Voyager's standard 2.5-liter EFI balance-shaft engine, when teamed with the automatic transaxle, provides up to 1,750\* pounds of towing capacity, covering your light trailer needs.

### Voyager/Grand Voyager models with V6 engines.<sup>†</sup>

Voyager's optional 3.0-liter or 3.3-liter MPI V6 engine and Grand Voyager with its standard 3.3-liter MPI V6 engine provide you with an additional 500 pounds of towing capacity for a total of 2,250 pounds. AWD models have a maximum towing capacity of 2,000\* lbs.

### Voyager/Grand Voyager SE and LE models with V6 engines, four-speed automatic transaxle and Heavy-Duty Trailer Towing Preparation Package.

Voyager SE and LE with available 3.0-liter or 3.3-liter MPI V6 engine<sup>†</sup> and four-speed automatic transaxle, and Grand Voyager models with standard 3.3-liter MPI V6 engine and four-speed automatic transaxle provide you with 3,100\* pounds of trailer towing ability for heavy towing/trailing needs, when equipped with the optional Heavy-Duty Trailer Towing Preparation Package. AWD models have a maximum trailer towing ability of 2,900\* lbs.

\*Based on a load of two passengers and luggage. <sup>†</sup>See page 24 for further engine information.



**POPULAR VALUE PACKAGE**

(Available for base and SE models, standard for LE models.)

Includes ■ Accessory floor mats, front and rear ■ Deluxe sound insulation ■ Electronic speed control ■ Engine oil pressure gauge ■ Voltage gauge ■ Lights for ash receiver, check gauges warning, door ajar; illuminated entry system, glove box, underhood; ignition switch time-delay; liftgate dual flood; washer fluid warning; map/reading, front (two) ■ Power liftgate release (base only) ■ Tachometer ■ Tilt steering column ■ Dual horns (base only) ■ Power door locks ■ Illuminated vanity mirrors (SE only) ■ 7-passenger seating (base only) ■ Luxury steering wheel

**LUXURY VALUE PACKAGE**

(Available for SE and LE models only.)

Includes Popular Value Package (SE only) plus ■ Power vent windows (SE only) ■ Underseat drawer (SE only) ■ Front storage and overhead consoles (SE only) ■ Chrysler Infinity I Sound System ■ Defroster, rear window, electric (SE only) ■ Dual power heated mirrors (SE only) ■ Power driver's seat (LE only) ■ Power windows, front doors only ■ Headlight time delay (SE only)

**HEAVY-DUTY TRAILER TOWING PREPARATION PACKAGE**

(Available for SE and LE models only.)

(V6 engine with four-speed automatic transaxle required.) Includes ■ 120-amp alternator ■ 625-amp battery ■ Heavy-duty brakes ■ Fifteen-inch road wheels ■ Heavy-duty radiator ■ Heavy-duty suspension ■ Heavy-duty transaxle oil cooler ■ Heavy-duty variable load turn signal flasher ■ P205/70R15 black sidewall tires (set of four) ■ Special trailer tow wiring harness ■ Conventional spare tire (NA on AWD models)

**FAMILY VALUE PACKAGE**

(Available for base and SE models.)

Includes ■ Air conditioning\* ■ Deluxe sound insulation ■ Dual-note horn (standard on SE) ■ Electric rear window defroster ■ Light Package

**SPORT HANDLING PACKAGE**

(Available on front-wheel-drive SE and LE models only.)

Includes ■ Heavy-duty brakes ■ Sport suspension ■ Rear sway bar ■ P205/70R15 BSW tires (set of four)

**DELUXE CONVENIENCE PACKAGE**

(Available for Voyager and all Voyager SE models.)

Includes ■ Electronic speed control ■ Tilt steering column ■ Luxury steering wheel

**POWER CONVENIENCE PACKAGE**

(Available for all Voyager SE models.)

Includes ■ Power door locks ■ Power windows, front doors only

**QUAD COMMAND SEATING PACKAGE**

(Available on all SE and LE models.)

Two quick-release bucket seats replace the intermediate bench seat.

**SEVEN-PASSENGER SEATING PACKAGE**

(Available for Voyager models.)

Includes ■ Front bucket seats with reclining seat-backs and folding armrests; second seat—two-passenger bench with fixed-back, side armrest and quick-release attachments; third seat—three-passenger bench with folding-back, adjustable feature (slides front-to-rear on tracks), and quick-release attachments ■ Dual rear storage bins with armrest covers incorporated into wheel wells

**LX DECOR PACKAGE**

(Available for Voyager LE models only.)

Includes ■ 3.0L V6 engine<sup>1</sup> (NA on AWD models) ■ Fifteen-inch cast aluminum road wheels (set of four) ■ LX nameplate on liftgate ■ Body-colored bodyside applique with bright rub strip ■ P205/70R15 all-season radial black sidewall tires (set of four) ■ Fog lamps ■ Heavy-duty brakes ■ 4-speed automatic transaxle (standard on AWD models)

**LIGHT PACKAGE**

(Available only as part of the Family Value Package or Popular Value Package. Standard on Voyager LE models.)

Includes ■ Ash receiver light ■ Dual liftgate-mounted floodlights ■ Front map/reading light ■ Front passenger underseat drawer light (when equipped) ■ Ignition switch with time-delay ■ Instrument panel door ajar and washer fluid warning lights ■ Glove box light ■ Underhood light ■ Illuminated entry system

**CONVERT-A-BED PACKAGE**

(Available on SE models except standard wheel-base AWD.)

Intermediate and rear bench seats fold into a handy bed that comfortably sleeps two people. (Late availability.)

**STORAGE CONVENIENCE PACKAGE**

(SE models only)

Includes ■ Forward storage console ■ Lockable underseat storage drawer

<sup>1</sup>There are special engine coolant requirements for field-installed air conditioning. Failure to follow these requirements may invalidate warranty. See your dealer for details.

<sup>2</sup>Built by Mitsubishi Motors Corporation.

**VOYAGER SOUND SYSTEMS**

**AM/FM STEREO RADIO**

(Standard on all Voyager models)

Includes electronic tuning, Dynamic Noise Reduction\*, bass/treble slide control, four-speaker system, ten-station pushbutton programming, integral digital clock

**AM/FM STEREO RADIO WITH CASSETTE TAPE PLAYER**

(Available on all models.)

Includes electronic tuning, Dynamic Noise Reduction\*, bass/treble slide control, cassette tape player with automatic reverse, locking fast-forward and rewind, four speakers, integral digital clock

**CHRYSLER INFINITY I SOUND SYSTEM**

(Available on all SE and LE models, and included with Luxury Equipment Discount Package.)

AM stereo<sup>1</sup>/FM stereo radio, electronic tuning, memory scan, seek-and-scan, Dynamic Noise Reduction\*; electronic cassette tape player with automatic reverse, true fast-forward and rewind, automatic Hi-Bias and metal tape sensor, tape program music search, Dolby B<sup>†</sup> Noise Reduction, motorized tape eject, electronic bass and treble control, joystick balance/fader speaker control, and Chrysler Infinity vehicle-equalized ten-speaker system; instruction/demonstration tape with musical selections, and dry-type head cleaner integral with tape leader; integral digital clock

**CHRYSLER INFINITY II SOUND SYSTEM**

(Available for SE and LE models.)

AM stereo<sup>1</sup>/FM stereo radio, electronic tuning, memory scan, seek-and-scan, Dynamic Noise Reduction\*; electronic cassette tape player with automatic reverse, true fast-forward and rewind, automatic Hi-Bias metal tape sensor, tape program music search, Dolby B<sup>†</sup> Noise Reduction, motorized insert and eject, five-band electronic graphic equalizer, joystick balance/fader speaker control, and Chrysler Infinity vehicle-equalized ten-speaker system; instruction/demonstration tape with musical selections, and dry-type head cleaner integral with tape leader; integral digital clock

\*Dynamic Noise Reduction is a trademark of National Semiconductor Corporation.

<sup>†</sup>Some AM stereo broadcasting may not be compatible with this radio.

<sup>‡</sup>Dolby B is a trademark of Dolby Laboratories. Certain models, packages, and options are subject to specific restrictions, requirements, or late availability. Consult your dealer for current ordering information.

**STANDARD SAFETY FEATURES**

■ Backup lights ■ Brake fluid pressure loss warning light (also serves as indicator when parking brake is applied) ■ Center high-mounted rear stoplight ■ Child Guard locks on sliding side door ■ Combination lap/shoulder belts for outboard seating positions; lap belts for rear center position ■ Dual braking system with separate brake fluid reservoirs in the master cylinder ■ Electronic ignition ■ Electric windshield and rear window washers and wipers ■ Energy-absorbing front seatbacks ■ Energy-absorbing steering column ■ Energy-absorbing sun visors ■ Fade-resistant front vented disc brakes ■ Glare reduction measures for instrument panel, steering wheel and windshield wipers ■ Hazard warning flasher system ■ Headlight and wiper circuit breakers with automatic reset ■ Ignition and steering column lock ■ Inside rearview mirror ■ Interlocking door latches ■ Key-left-in-ignition warning ■ Non-override door locks (except driver's door) ■ Power outside rearview mirrors ■ Recessed inside door release handles ■ Reinforced windshield header and roof ■ Resilient window crank knobs ■ Safety-Rim wheels ■ Seat belt reminder system ■ Side marker lights and reflectors ■ Turn signals with lane-change feature

**FUNCTIONAL**

	VOYAGER	VOYAGER SE & AWD	VOYAGER LE & AWD	VOYAGER SE & AWD	VOYAGER LE & AWD
Alternator—90-ampere	S	S	S	S	S
Battery—500-ampere; maintenance-free	S	S	S	S	S
Brakes—Power-assisted: vented front disc, self-adjusting rear drum, dual hydraulic with height-sensing dual proportioning valve	S	S	S	S	S
Brakes <sup>1</sup> —Four-wheel antilock braking system, 3.3L V6 required	NA	O	O	O	O
Coolant Overflow Reservoir	S	S	S	S	S
Electronic Direct Ignition System <sup>1</sup> —3.3-liter engine	NA	O	O	S	S
Electronic Ignition and Voltage Regulator	S	S	S	S	S
Engine <sup>1</sup> —2.5-liter EFI (NA on AWD models)	S	S	S	NA	NA
Engine <sup>1</sup> —3.0-liter MPI V6 (See pg. 24 for details) (NA on AWD models)	O	O	O	NA	NA
Engine <sup>1</sup> —3.3-liter MPI V6 (Std on AWD models)	NA	O	O	S	S
Fuel Filler Door—Remote cable release	NA	NA	S	NA	S
Fuel Tank—20-gallon (18-gallon on AWD)	S	S	S	S	S
Headlights—Single halogen: aero-type	S	S	S	S	S
Hood—Remote cable release	S	S	S	S	S
Speed Control—Electronic	P	P	S	P	S
Steering—Rack-and-pinion type: power-assisted	S	S	S	S	S
Suspension—Front: gas-charged position-sensitive struts and coil springs	S	S	S	S	S
Suspension—Rear: gas-charged shocks and leaf springs	S	S	S	S	S
Suspension System—Heavy-duty	O	O	O	O	O
Transaxle <sup>1</sup> —Automatic: three-speed (NA on AWD models)	S	S	S	NA	NA
Transaxle <sup>1</sup> —Four-speed automatic overdrive (Std on AWD)	NA	O	O	S	S

**EXTERIOR**

Corrosion Protection—Urethane lower body protective coating; extensive use of galvanized steel	S	S	S	S	S
Door—Cargo compartment, right side: sliding, with vented glass, outside key lock, and Child Guard lock	S	S	S	S	S
Fascias—Front and rear: color-keyed, with bright rub strips	S	S	S	S	S
Glass—Sunscreen	O	O	O	O	O
Glass—Tinted: all windows	S	S	S	S	S
Glass—Vented: bodyside	S	S	S	S	S
Liftgate—Fixed glass:with outside key lock	S	S	S	S	S
Luggage Rack—Roof-mounted (NA on AWD models)	O	O	O	O	O
Mirrors—Exterior, dual rearview power remote control	S	S	NA	S	NA
Mirrors—Exterior, dual rearview power remote control, heated	NA	P	S	P	S
Moldings—Bodyside and liftgate: woodgrain	NA	NA	S	NA	S
Moldings—Rear window and windshield: flush, black	S	S	S	S	S
Tape Stripes—Bodyside and liftgate	NA	S	P	S	P
Wheel—Cast aluminum (Set of 4) (Std on Grand Voyager LE AWD)	NA	E	E	E	E
Wheel Covers—Luxury (set of four)	P	S	S	S	S
Wheel Covers—Deluxe (set of four)	S	NA	NA	NA	NA
Wheel Covers—14" wire with locks (set of four) (NA on AWD models)	O	O	O	NA	NA
Woodgrain Appliques—Bodyside and liftgate	NA	NA	S	NA	S

**INTERIOR**

Air Conditioning <sup>2</sup> —Front	O	O	S	O	S
Air Conditioning <sup>2</sup> /Heater—Rear (FWD models only)	NA	NA	NA	O	O

**INTERIOR (cont.)**

	VOYAGER	VOYAGER SE & AWD	VOYAGER LE & AWD	VOYAGER SE & AWD	VOYAGER LE & AWD
Assist Handle—Liftgate closing	S	S	S	S	S
Assist Strap—Rear passenger: mounted on front passenger seatback	P	S	S	S	S
Carpeting—Driver, passenger, and cargo compartments: color-keyed	S	S	S	S	S
Cellular Phone—Mobile <sup>3</sup>	O	O	O	O	O
Cellular Phone—Portable <sup>3</sup>	O	O	O	O	O
Chimes—Warning: fasten seat belts, headlights on, key-in-ignition	S	S	S	S	S
Cigar Lighter	S	S	S	S	S
Console—Forward storage includes cubby bin, large lower storage bin with cassette holders	NA	P	S	P	S
Console—Overhead, includes mini trip computer, map reading lights, storage compartments for sunglasses and garage door opener, and an outside temperature and compass readout	NA	P	S	P	S
Defroster—Liftgate, electric	O	O	S	O	S
Demisters—Front door windows	S	S	S	S	S
Door Locks—Power	O	O	S	O	S
Glove Box	S	S	S	S	S
Heater—With bi-level ventilation	S	S	S	S	S
Horn—Dual-note	P	S	S	S	S
Instrumentation—Fuel gauge, trip odometer, speedometer, engine coolant temperature gauge	S	S	S	S	S
Instrumentation—Full gauge cluster; tachometer, voltage and oil pressure gauges	P	P	S	P	S
Insulation—Deluxe body sound	P	P	S	P	S
Insulation—Special body sound	S	S	NA	S	NA
Leather-With-Vinyl-Trim Interior	NA	NA	O	NA	O
Liftgate Release—With instrument panel switch: power	P	S	S	S	S
Lights—Ash receiver, door ajar, glove box, underhood, illuminated entry system, ignition switch time-delay, liftgate dual flood, washer fluid warning, map/reading (front), storage drawer (when equipped)	P	P	S	P	S
Lights—Front and rear compartments: dome	S	S	S	S	S
Mirror—Rearview: day/night	S	S	S	S	S
Mirror—Visor vanity: non-illuminated (illuminated on LE)	S	S	S	S	S
Radio—AM/FM stereo: (see details on page 26)	S	S	S	S	S
Radio—AM/FM stereo with cassette tape player (see details on page 26)	O	O	O	O	O
Radio—Chrysler Infinity I Sound System (see details on page 26)	NA	O	O	O	O
Radio—Chrysler Infinity II Sound System (see details on page 26)	NA	O	O	O	O
Restraint System—Unibelt, with low-tension retractors on outboard seats; lap belts at rear center seating position: color-keyed	S	S	S	S	S
Steering Wheel—Deluxe two-spoke: vinyl	S	S	NA	S	NA
Steering Wheel—Luxury	P	P	S	P	S
Storage Drawer—Under front passenger bucket seat: lockable	NA	P	S	P	S
Windshield Wipers—Deluxe: variable intermittent wipe	S	S	S	S	S
Wiper/Washer—Liftgate: fixed intermittent wipe	S	S	S	S	S

S—Standard. O—Optionally available. P—Package only. PR—Extra-cost package required. NA—Not available. NC—No-charge option.

<sup>1</sup>See dealer for current availability.

<sup>2</sup>There are special engine cooling requirements for field-installed air conditioning. Failure to follow these requirements may invalidate warranty. See your dealer for details.

<sup>3</sup>Dealer installed/supplied item. See page 29 for additional information.



EXTERIOR COLORS

INTERIOR COLORS

	BORDEAUX	CHAMPAGNE	TWILIGHT BLUE	MEDIUM QUARTZ
Black Clear Coat				
Twilight Blue Pearl Coat*				
Black Cherry Pearl Coat				
Platinum Silver Metallic Clear Coat*				
Light Champagne Metallic Clear Coat*				
Diamond Blue Metallic Clear Coat				
Dark Quartz Gray Metallic Clear Coat				
Claret Red Pearl Coat*				
Safari Brown Satin Glow Clear Coat				
Bright White Clear Coat				
<b>TWO-TONE EXTERIOR COLORS†</b>				
Diamond Blue Metallic Clear Coat				
Dark Quartz Gray Metallic Clear Coat				
Claret Red Pearl Coat				
Platinum Silver Metallic Clear Coat				
Light Champagne Metallic Clear Coat				
<b>LX DECOR PACKAGE COLOR COMBINATIONS‡</b>				
Black Cherry Pearl Coat§				
Dark Quartz Gray Metallic Clear Coat§				
Twilight Blue Pearl Coat§				
Bright White Clear Coat§				

\*Available at extra cost. †Available at extra cost on Voyager SE. No-charge option on Voyager LE as replacement for standard woodgrain treatment. Window surround area in accent color. ‡Available only on Voyager LE equipped with the optional LX Decor Packages. §With Medium Quartz accents.

\*Base Voyager only. NOTE: Due to printing limitations, the colors shown will vary slightly from actual hues. See your Plymouth dealer for accurate color chips. Clear Coat finish is standard on every 1991 passenger car built by Chrysler Motors.

TIRES

TIRE SIZE AND TYPE (SET OF 4)	VOYAGER	VOYAGER SE	VOYAGER SE (AWD)	VOYAGER LE	GRAND VOYAGER LE (AWD)	GRAND VOYAGER SE (AWD)	GRAND VOYAGER LE (AWD)	GRAND VOYAGER SE (AWD)	GRAND VOYAGER LE (AWD)
P195/75 R14 Steel-Belted Radial Black Sidewall	S	S	NA	S	NA	NA	NA	NA	NA
P205/70 R14 Steel-Belted Radial White Sidewall	P	P	NA	O	NA	NA	NA	NA	NA
P205/70 R15 Steel-Belted Radial Black Sidewall	P	P	S	P	S	S	S	S	S
P205/70 R15 Steel-Belted Radial White Sidewall	NA	P	P	O	O	P	P	O	O
Conventional Spare Tire (14" or 15" depending on model)	O	O	NA	O	NA	O	NA	O	NA
Compact Spare Tire	S	S	S	S	S	S	S	S	S

S—Standard. O—Optional. P—Package required. NA—Not available

SCHEDULED MAINTENANCE

Here is a partial list of Plymouth Voyager's standard scheduled maintenance items. The complete list can be found in the Owner's Manual. Voyager with standard 2.5-liter engine.

Engine oil and filter change ..... 7,500 miles or 12 months  
 Spark plug change ..... each 30,000 miles  
 Air filter replacement ..... each 30,000 miles  
 Engine coolant replacement ..... each 30,000 miles or 2 years  
 For severe service maintenance schedule, refer to Owner's Manual.

VOYAGER / GRAND VOYAGER OPTIONS PACKAGES

	VOYAGER	VOYAGER SE	VOYAGER SE (AWD)	VOYAGER LE	GRAND VOYAGER LE (AWD)	GRAND VOYAGER SE (AWD)	GRAND VOYAGER LE (AWD)	GRAND VOYAGER SE (AWD)	GRAND VOYAGER LE (AWD)
Converta-Bed Package (Late availability)			O				O	O	
Deluxe Convenience Package		O	O	O	S	S	O	O	S
Storage Convenience Package			O	O	S	S	O	O	S
Heavy-Duty Trailer Tow Preparation Package			O	O	O	O	O	O	O
Light Package	P <sup>1</sup>	P <sup>1,2</sup>	P <sup>1,2</sup>	S	S	P <sup>1,2</sup>	P <sup>1,2</sup>	S	S
Luxury Value Package		O	O	O	O	O	O	O	O
LX Decor Package					O	O			
Popular Value Package	O	O	O	S	S	O	O	S	S
Power Convenience Package		O	O			O	O		
Quad Command Seating Package		O	O	O	O	O	O	O	O
Seven-Passenger Seating Package	O	S	S	S	S	S	S	S	S
Sport Handling Package		O		O		O		O	
Family Value Package	O	O	O	S	S	O	O	S	S

S—Standard. O—Optional. P—Package only. <sup>1</sup>Available as part of the Family Value Package or Popular Value Package on base Voyager and Voyager SE. <sup>2</sup>Available as part of the Luxury Value Package.



Quality Worth Backing

All Chrysler Motors domestically built automobiles and light trucks now benefit from the 7/70 Power Train Limited Warranty. Upon expiration of the basic 12-month or 12,000-mile Basic Limited Warranty, coverage is extended on power train components to seven years or 70,000 miles.\* This represents one of the most comprehensive original limited warranties available on cars and trucks built and sold in the United States, and points out Chrysler Motors' pride in building and backing its products the right way.

In addition to the 7/70 Power Train Limited Warranty described above, all domestically built Chrysler Motors automobiles offer the 7/100 Anticorrosion Limited Warranty. Your dealer will repair or replace at no charge outer body sheet metal panels found to have developed perforation (rust-through) in normal use up to seven years or 100,000 miles. See your dealer for a copy of the limited warranties.

\*A deductible applies. **Optional Service Contract Coverage** Chrysler Service Contracts provide you with additional peace-of-mind protection for your new vehicle. Chrysler Motors offers a variety of plans to meet your needs. Plan coverage begins after your vehicle's basic warranty expires. A deductible applies. Allowances for car rental and towing are also included. See your dealer for details.



MOPAR parts are engineered by Chrysler Motors for use in your new Plymouth Voyager. When replacement is necessary, be sure to specify MOPAR parts. Used by professional automotive technicians worldwide.

**Chrysler Cellular Systems** OKI® Telecom manufactures, services, and is the warrantor of the Visophone, Mobile phone and Portable phone products that are available on selected Chrysler Motors vehicles. See your dealer for a copy of the limited warranties. Restrictions apply.

**Consider Leasing** More consumers are considering leasing as an alternative to buying. Leasing a new Plymouth Voyager usually involves a small security deposit and a first month's lease payment. Monthly payments frequently are less than financing a new car purchase. Ask your dealer for details.

**Chrysler Credit Making the best even more affordable.** Chrysler Credit offers a variety of finance programs that will help make your new Plymouth Voyager even more affordable. These special finance and leasing programs are designed to meet the needs of today's automotive buyer. They include Gold Key Lease, America's Choice Payment Plan, College Graduate Plans, Retail Financing, and more. Ask your salesperson for details.

**Chrysler Purchase Assistance Program for the Physically Challenged** Cash reimbursements of up to \$500 are available for qualified adaptive driving devices on 1991 Chrysler Motors cars and trucks. For further information, contact your dealer or the PHYSICALLY CHALLENGED RESOURCE CENTER AT 1-800-255-9877. All product illustrations and specifications are based upon current information at the time of publication approval. Although descriptions are believed correct, complete accuracy cannot be guaranteed. Chrysler Motors reserves the right to make changes from time to time, without notice or obligation, in prices, specifications, colors and materials, and to change or discontinue models. See your dealer for the latest information.

Plymouth and MOPAR are registered trademarks, and Voyager is a trademark of Chrysler Corporation.

**Buckle up for safety.** Form No. 74-383-0010 8/90 (370M) Litho in U.S.A.





I'm proud of the quality and honest value we build into our products. But a lot of Americans aren't aware of it and that's got to change. Our 1991 Plymouths have real advantages over their import and domestic competition. Take Plymouth Voyager. We not only invented the mini van, this year we've re-invented it. The new 1991 Plymouth Voyager takes the mini van concept to a new level, with contemporary aerostyling and a totally redesigned interior; available four-wheel antilock brakes and all-wheel drive. It's all backed by seven years or 70,000 miles of power train protection, and seven years or 100,000 miles against outer body rust-through—one of the best limited warranties of any vehicle made. All of these advantages add up to a mini van that we believe no other car company in the world can beat. Take a good look at Plymouth Voyager versus the competition. For style, value, standard features, and advanced engineering, the other guys simply don't measure up. Advantage: Plymouth. But most of all, Advantage: customer.

*Lee A. Iacocca*



VOYAGER • ACCLAIM • SUNDANCE • LASER • COLT • VISTA