



Porsche Cars North America, Inc.
980 Hammond Drive, Suite 1000
Atlanta, Georgia 30328

Dr. Ing. h.c. F. Porsche AG is the owner of numerous trademarks, both registered and unregistered, including without limitation the Porsche Crest®, Porsche®, Boxster®, Carrera®, Cayenne®, Cayman®, Panamera®, Tiptronic®, VarioCam®, PCM®, 911®, 4S®, FOUR, UNCOMPROMISED® and the model numbers and distinctive shapes of the Porsche automobiles, such as the federally registered 911 and Boxster automobiles. The third-party trademarks contained herein are the properties of their respective owners. Specifications, performance standards, standard equipment, options, and other elements shown are subject to change without notice. Some options may be unavailable when a car is built. Some vehicles may be shown with non-U.S. equipment. Please ask your dealer for advice concerning the current availability of options and verify the optional equipment that you ordered. Porsche recommends seat-belt usage and observance of traffic laws at all times.

All fuel consumption and emissions data contained herein are derived from U.S. tests and were accurate at time of press.

The new Cayenne • To the point

MKT 001 192 10



PORSCHE



The new Cayenne
To the point



The new Cayenne	4
Model range	6
Design	8
Cayenne	10
Cayenne S	12
Cayenne S Hybrid	14
Cayenne Turbo	16
Drive systems and chassis	18
Engines	20
Engine technology	26
Transmission	32
Off-road capability	38
Chassis	40
Safety and environment	48
Safety	50
Environment	60
Comfort and transport	66
Comfort	68
Driver assistance systems	92
Transport	96
Personalization	100
Tourist Delivery	113
Service	114
Summary	116
Technical data	118
Index	124
Colors	126

Like every Porsche, the Cayenne poses a simple question about performance: Can the soul of a Porsche exist within the body of a rugged, versatile SUV? The first Cayenne quickly proved that such an idea was no idle fantasy. In fact, its character traits became so firmly established, so focused in their purpose, that they have now evolved into an entirely new generation of Cayenne models, each one more dynamic, more comfortable and more fuel-efficient than ever before.

The new Cayenne.
To the point.
More Porsche than ever.



A wider range. A deeper connection.

The Cayenne models.

Take a look at the Cayenne model range, and you will see the Porsche principle of engineering evolution executed in steel, aluminum and leather. Each example of the new Cayenne advances its own variation of a thesis first established by the original Cayenne: that the utility of an SUV can coexist with the performance of a Porsche sports car.

The Cayenne now comes in a wider choice of models, including the new Cayenne S Hybrid. All of these new Cayenne models benefit from the use of lightweight material and technical innovation designed to achieve a more dynamic, more comfortable, and more efficient Porsche.

The new Cayenne S Hybrid uses a parallel full hybrid system (p. 14) to harness the fuel-saving synergies of a compact electric motor assisting the powerful supercharged V6 engine.

The new Cayenne and new Cayenne S are now more powerful and fuel-efficient, while also

delivering exceptional off-road capability. This has been achieved through the use of advanced technologies such as Direct Fuel Injection (DFI, p. 28), eight-speed Tiptronic S (p. 32) and VarioCam Plus (p. 27).

The new Cayenne Turbo uses a 4.8-liter, twin-turbo V8 powerplant

to develop 500 horsepower. Its formidable power is transferred to the road via an eight-speed Tiptronic S (p. 32), while Porsche Torque Vectoring Plus (PTV Plus, p. 40) enhances driving dynamics and stability. Standard features include Bi-Xenon™ headlights with Porsche Dynamic Light System (PDLS, p. 51).

No matter which Cayenne you choose, you'll feel the connection between driver and machine deepen, the bond between you and the road strengthen. And isn't that the whole point?



Sleeker. More aggressive.
Just what an SUV from Porsche should be.

Design.

There is a school of thought that an SUV must be big and boxy, as if its brawny ruggedness could only come from considerable body mass. Thankfully, Porsche designers did not attend that school.

The new Cayenne takes a more enlightened approach to marriage of sport and utility. Its taut, sleek shape is the result of Porsche's belief that form must follow the demands of function, not the whims of fashion. Consider

the lines of the new Cayenne: The exterior is unmistakably Porsche. The sharper profile exudes purpose, which is further emphasized by the dynamic rear roof pillars and flowing coupé-like silhouette.



The contours of the front section draw the eye, reflecting the car's excellent dynamics at first glance. The elongated hood is reminiscent of Porsche race cars from the 1960s.

The front wheel arches and taut flanks are extremely well-defined, while the "power-domed" hood further underlines the sheer power and resolution within—this is particularly dominant on the Cayenne Turbo.

The rear wheel arches are streamlined and muscular, while the contoured roof spoiler pays homage to the Carrera GT. The tapered rear windshield and streamlined rear section underline the flared wheel arches—a design signature of the Porsche 911 sports cars.

Inside, the desire to achieve greater agility, flexibility and everyday practicality led our designers to a complete redesign of the interior.

The rear cabin area is larger and more variable than before. It features split-folding seats with fore/aft adjustment and adjustable backrest angle—for extra legroom and greater comfort. In addition, a wide range of new materials has been used. The changes are many, but the reason is singular: to sharpen the focus on you and your passengers.

Change everything.
Just don't touch the Crest.

The new Cayenne.



When we presented the first Cayenne in 2002, there were those who viewed the idea of such a Porsche with skepticism. Could it even be considered a Porsche? After all, it had four doors. It seemed such a radical departure for a company whose sports cars had always been lightweight, nimble-handling machines of the highest efficiency. Yet Porsche engineers managed to fuse those exact qualities with those of a rugged, roomy SUV.

That core Cayenne concept remains intact, and with good reason. The Cayenne was an instant success, earning both critical praise and popular acceptance while reaching 100,000 in sales faster than any Porsche model ever. We've just continued to improve it.

The new Cayenne is lighter—dropping up to 364 pounds, depending on the specification. With less mass to move, the power of the Cayenne translates into quicker acceleration, faster reflexes and shorter braking.

Its 3.6-liter, naturally aspirated V6 engine uses Direct Fuel Injection (DFI, p. 28), variable-valve timing on both inlet and exhaust, and a variable-resonance intake manifold to do more with less. The figures speak for themselves: rated at 300 horsepower, with a maximum torque of 295 lb.-ft., the new Cayenne records a top track speed of 142 mph and a 0–60-mph time of 7.1 seconds. With less fuel consumption than ever before.

The Porsche Traction Management (PTM, p. 36) combines active all-wheel drive with an electronically variable multi-plate clutch, Automatic Brake Differential (ABD) and Anti-Slip Regulation (ASR). PTM ensures the perfect distribution of drive torque to all four wheels, whether on long straights, through tight corners or on surfaces with different friction coefficients: for dynamic handling and increased traction. Drive is transmitted through a sport-tuned six-speed manual gearbox (p. 32), which ensures optimal progression through the gears. The gear lever throw is short and precise, with only minimal driver effort required. In addition to the standard

18-inch Cayenne wheels and new larger brakes, the Cayenne can be fitted with the optional Porsche Ceramic Composite Brake (PCCB, p. 54)—for outstanding brake performance. Another key advantage: a total weight savings of approximately 50 percent compared with that of equivalent cast-iron discs.

The list of standard equipment includes Bluetooth® hands-free phone interface, AUX-in, Partial Leather seats, climate control, the CDR-31 audio system with touchscreen, universal audio interface, cruise control and auto headlights. For added convenience, there's also a "Welcome Home" lighting function. When you arrive at a destination after dark, the headlights remain illuminated for a user-defined period, lighting your path from the vehicle.

400 horsepower. Eight speeds. Total Porsche.

The new Cayenne S.



The “S” affixed to a Porsche model has always been an indication of heightened performance and abundant reserves of power. With the Cayenne S, the special letter isn’t your only visual clue: The black slats on the air intakes and the 18-inch Cayenne S III wheels also hint at what lies within.

Under the hood, the new, lighter Cayenne S is fitted with a 4.8-liter, naturally aspirated V8 engine that deploys Direct Fuel Injection (DFI, p. 28), VarioCam Plus (p. 27) and a two-stage intake manifold to create 400 horsepower and maximum torque of 369 lb.-ft. Top track speed is 160 mph, and the Cayenne S accelerates from

0–60 mph in as little as 5.6 seconds. All this with impressive fuel economy, thanks to a weight reduction of 397 pounds.

Of course, to apply exceptional power like this requires precise control. Drive is transmitted to the road by the eight-speed Tiptronic S; it includes two ergonomic switches for manual gear changes (p.33) on the standard multifunction steering wheel.

The new Cayenne S also uses Porsche Traction Management (PTM, p. 36). This active all-wheel-drive system features an electronically variable, map-

controlled multi-plate clutch, an Automatic Brake Differential (ABD, p. 34) and Anti-Slip Regulation (ASR, p. 34). Working in conjunction with the advanced Porsche Stability Management (PSM, p. 56), PTM ensures the required torque split in every driving scenario, whether on-road or off-, during spirited driving or leisurely journeys, or even when towing heavy loads.

Other features that are standard include the Bluetooth® hands-free phone interface, universal audio interface, AUX-in and a moonroof.

A Porsche powered like no other.

The new Cayenne S Hybrid.



Since the company was founded in 1948, we have always gone our own way. This is the hallmark of our independent spirit. Only thus can we continue to meet our high performance standards. And yours. For the new Cayenne S Hybrid, we chose a highly sophisticated technical concept, as we felt that this would perfectly embody the key principle of an alternative drive: efficiency.

The new Cayenne S Hybrid offers all the advantages of a hybrid. And all the performance advantages of a Porsche.

The new parallel full hybrid system (p. 14) on the new Cayenne S Hybrid combines a 3.0-liter, supercharged V6 engine and an electric motor. The engine delivers 333 horsepower, while the electric motor generates 47 horsepower. Working in

tandem, they produce a total output of 380 horsepower and maximum torque of 428 lb.-ft. The top track speed is 150 mph, with acceleration from 0–60 mph in 6.1 seconds.

On the parallel full hybrid, the electric motor and a decoupler are integrated directly into the drivetrain between the gasoline engine and the eight-speed Tiptronic S. The decoupler ensures positive engagement with the combustion engine, thereby offering several benefits—both for the driver and the environment.

Under moderate acceleration, the electric motor can power the vehicle independently. The electric motor can also be used to recuperate energy during braking and charge the battery. In addition, the electric motor can be used to boost performance—for faster acceleration, particularly when pulling away.

The hybrid system also brings significant advantages when not driving in city traffic. The vehicle can simply “coast” along many stretches of road without any power at all. Together with the Auto Start Stop function, the parallel full hybrid offers exceptional levels of performance and efficiency.

The “hybrid” designation on each front fender is a discreet reference to the innovative power system within. Inside the Cayenne S Hybrid, the TFT color display in the instrument cluster provides information on the current energy flow. Further driving data is displayed via the optional Porsche Communication Management (PCM).

**Lighter, leaner, cleaner.
A Porsche adds by subtraction.**

The new Cayenne Turbo.



Porsche helped usher in a new age in sports-car performance when we introduced the 911 Turbo in 1974. With an engine of compact size, that first Porsche Turbo produced staggering performance figures. The new Cayenne Turbo starts with a 4.8-liter V8 and adds twin turbochargers. Yet its overall weight has also been reduced by 408 pounds, lighter than its predecessor.

An ideal power/weight ratio that has been perfected in a half-century's worth of Porsche race cars. The same principle has been applied in the new Cayenne Turbo. The twin-turbo, Direct Fuel Injection (DFI) V8 engine delivers 500 horsepower and maximum torque of 516 lb.-ft. The top track speed of 172 mph and a 4.4-second sprint from 0–60 mph are proof of the formula's effectiveness.

Optimal traction and handling stability are provided by Porsche Traction Management (PTM,

p. 34) active all-wheel drive. Also connecting the Cayenne Turbo to the road are the 19-inch Cayenne Turbo wheels and an air suspension system, featuring self-leveling, ride-height control and Porsche Active Suspension Management (PASM, p. 41). This electronic damping control system offers continuous adjustment of the damping forces on each wheel, depending on current road conditions and driving style.

In the new Cayenne Turbo interior, luxury is key. Befitting the Cayenne Turbo's status as the top-of-the-line model, the list of standard equipment includes an interior package in Smooth-Finish Leather, an Alcantara® roof liner, the Bose® Surround Sound system, a Bluetooth® hands-free phone interface, universal audio interface, AUX-in, USB port, XM® Satellite Radio, Porsche Communication Management (PCM) with navigation module, Adaptive Sport Seats with memory package (18-way) and auto headlights.

Exterior features exclusive to the new Cayenne Turbo include Bi-Xenon™ headlights with Porsche Dynamic Light System (PDLS, p. 51), larger air intakes and a distinctive “power dome” on the hood—a clear reference to the enormous potential within. Another clear statement is the distinctive sound from the dual-twin tailpipes.

The new Cayenne Turbo: phenomenal performance with comfort and efficiency. Did you expect anything less from a turbocharged Porsche?

How could we make the new Cayenne more powerful and yet, at the same time, more efficient? Where should we start? How about 1948, when the Porsche concept of maximum power with minimum weight first took shape.



Drive systems and chassis

Hybrid, V6, V8, twin-turbo V8. Many different options.
One outcome: Porsche.

Engines.

The drive system of the new Cayenne S Hybrid.

To create the new Cayenne S Hybrid, Porsche engineers opted for a solution that satisfies the requirements perfectly: the parallel full hybrid. A 3.0-liter, supercharged V6 engine and an electric motor provide a total output of 380 horsepower and maximum torque of 428 lb.-ft. This results in 0–60 mph in 6.1 seconds.

The V6 engine's use of a supercharger ensures high levels of torque, even at low engine speeds. 325 lb.-ft. of torque is available between 3000 and 5250 rpm, enabling a low-rev, economic driving style while offering exceptional reserves of power.

At 288 volts, with a maximum output of 47 horsepower, the extremely compact and highly efficient electric motor also acts as a starter motor and alternator.

On the parallel full hybrid, the electric motor is integrated directly into the drivetrain. The hybrid module is situated between the transmission and the gasoline engine. The engine is engaged and disengaged using a specially designed decoupler.

The complex interplay between combustion engine, decoupler, electric motor and battery is controlled by the electronic engine management system. It receives all information on the driving and energy status and it controls both drive systems to ensure optimal performance in any driving scenario. It shuts off the combustion engine and switches it back on. Thanks to the ultra-fast decoupler and instantaneous

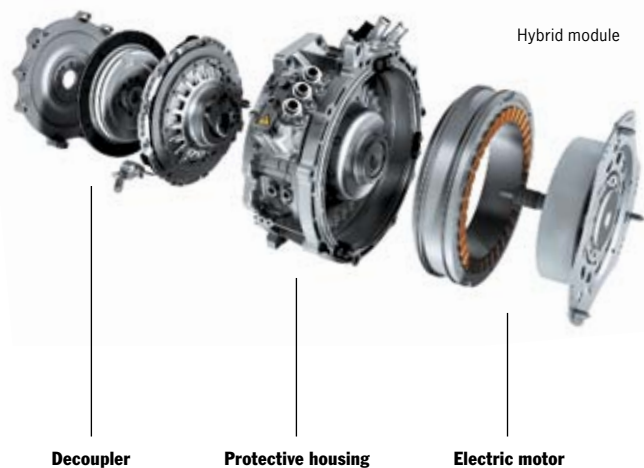

Decoupler

Protective housing

Electric motor



Parallel full hybrid system

engine start-up, all of this goes unnoticed by the driver. Under moderate acceleration, the electric motor can power the vehicle independently using electricity alone, for driving quietly through residential areas, for example. In addition, it can be used to boost performance—for faster acceleration, particularly when pulling away.

The parallel full hybrid system also comes into its own when driven at higher speeds. Without drive power needed from the engine and electric motor, the gasoline engine is automatically disengaged from the drivetrain and shuts off: The Cayenne S Hybrid continues to “coast” along. Engine drag and the associated deceleration effect are eliminated, and efficiency is increased.

The “e-power” function expands the range in which the vehicle can be run solely on electric power. The throttle map is adapted so that the combustion engine is engaged later than when in “Normal” mode, depending on performance requirements. This function is activated via a button on the center console.

The hybrid system in the new Cayenne S Hybrid features a high-voltage nickel-metal hydride (NiMH) battery consisting of 240 cells. It provides the electric motor with the energy required for the vehicle to drive short distances solely on electric power.

The compact battery is located under the cargo floor in the cargo area. Weighing 176 pounds, its dimensions are 16.8 in. x 36.4 in. x 11.3 in.

The battery is designed to last without the need for any maintenance over its lifetime. The electric motor also functions as a generator, so it can charge the battery under certain conditions: when the gasoline engine is in part-throttle mode, and through energy recovery during braking.

A special battery management and cooling system maintains a constant temperature and protects the battery from overheating. It also monitors the charge/discharge processes. As a result, the life of the battery is optimized and its suitability for everyday use ensured, while offering a high capacity: 1.7 kWh.

Systems that are usually dependent on the output provided by the gasoline engine, such as climate control, power steering and Brake Assist, run solely on electricity in the new Cayenne S Hybrid. As they do not rely on output from the engine, these functions remain active when the vehicle is running in electric mode or when it is “coasting” along with the engine turned off.

When it comes to hybrid vehicles, the new Cayenne S Hybrid takes a completely new path.

The engine of the new Cayenne.

All Cayenne engines use Direct Fuel Injection (DFI, p. 28) to achieve a significant increase in specific power and torque, as well as better fuel economy and lower emissions.

The new Cayenne features a 3.6-liter, naturally aspirated V6 engine with Direct Fuel Injection (DFI, p. 28), and variable-valve timing on both inlet and exhaust. The engine delivers 300 horsepower at 6300 rpm and maximum torque of 295 lb.-ft. at 3000 rpm with a 0–60-mph time of 7.1 seconds. Maximum track speed is 142 mph (manual transmission).



Cayenne engine

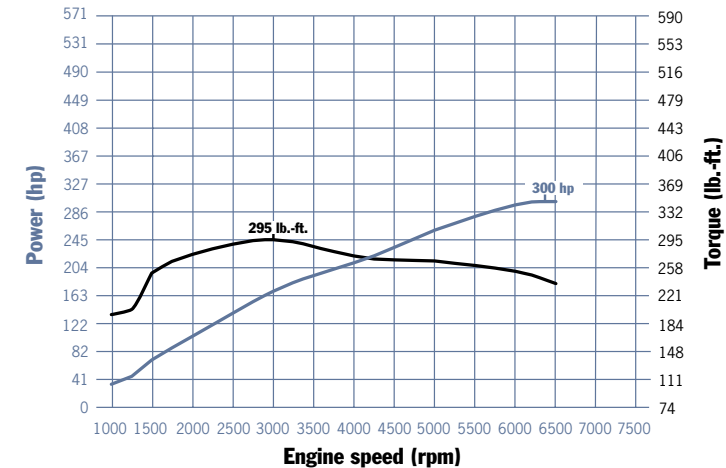
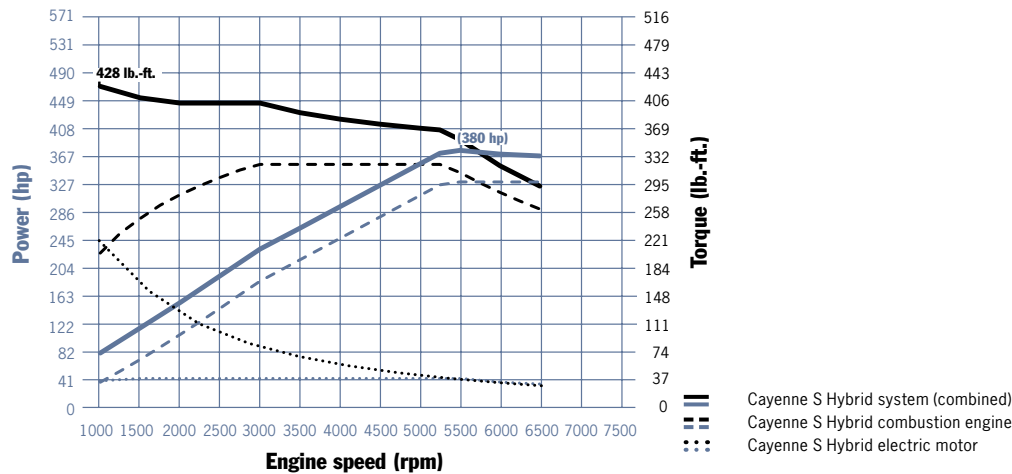

Cayenne: 300 horsepower at 6300 rpm, 295 lb.-ft. at 3000 rpm

The engine of the new Cayenne S.

The new Cayenne S has a 4.8-liter, naturally aspirated V8 engine with Direct Fuel Injection (DFI, p. 28), VarioCam Plus (p. 27) and a two-stage intake manifold. The unit delivers 400 horsepower at 6500 rpm. Maximum torque of 369 lb.-ft. is available at 3500 rpm.

With the standard eight-speed Tiptronic S transmission, the Cayenne S is capable of accelerating from 0–60 mph in 5.6 seconds. Top track speed is 160 mph.



Cayenne S engine

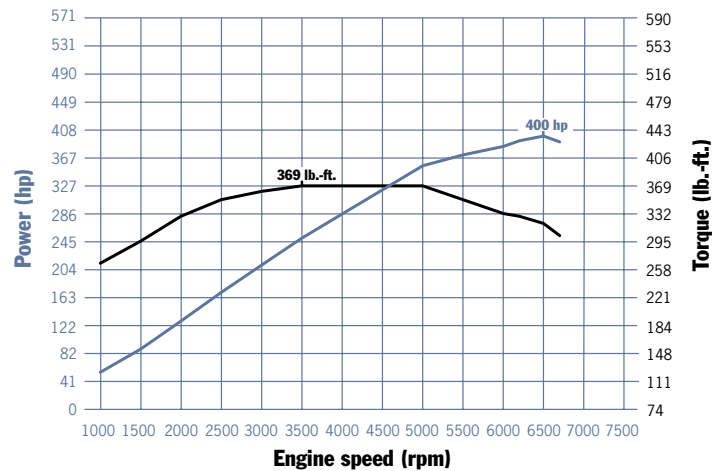

Cayenne S: 400 horsepower at 6500 rpm, 369 lb.-ft. at 3500 rpm

The engine of the new Cayenne Turbo.

The new Cayenne Turbo is powered by a 4.8-liter, twin-turbo V8 engine featuring Direct Fuel Injection (DFI, p. 28), VarioCam Plus (p. 27) and an intercooler. It generates 500 horsepower at 6000 rpm. Maximum torque of 516 lb.-ft. is available between 2250 and 4500 rpm. Maximum track speed is 172 mph, while the sprint from 0–60 mph takes just 4.4 seconds. The eight-speed Tiptronic S transmission helps make the new Cayenne Turbo remarkably fuel-efficient.



Cayenne Turbo engine

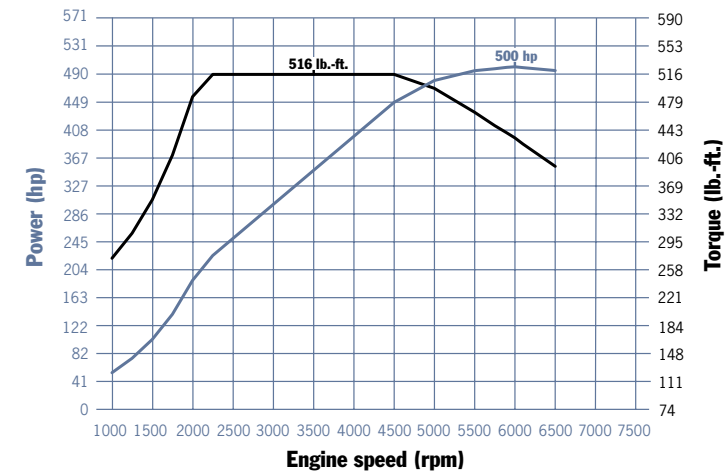

Cayenne Turbo: 500 horsepower at 6000 rpm, 516 lb.-ft. between 2250 and 4500 rpm

The heart of every Porsche.
Applying power with intelligence.

Engine technology.

Auto Start Stop function.

All Cayenne models equipped with the new eight-speed Tiptronic S also feature a fuel-saving innovation, the Auto Start Stop function. When activated, here's how it works: Say, for example, you are stopped at a traffic light with your foot on the brake pedal. The Auto Start Stop function will automatically turn off the

engine. But not everything stops: All audio and communication systems remain switched on, and the standard climate control continues to maintain the selected temperature. Although the engine is not running, the only change you'll perceive is peace and quiet, and—thanks to greater fuel economy—peace of mind. Remove your foot from the brake and the engine instantly returns to life.

The system is deactivated in certain situations, such as when the outside temperature is very high or the battery charge is low. The starter motor has been revised to cope with the additional demands of the system, and the battery is continuously monitored for the level of charge and condition. The battery and starter motor are replacement parts that are subject to greater wear

and tear with frequent use of the Auto Start Stop function.

Standard on the Cayenne S, Cayenne S Hybrid and Cayenne Turbo. Available for the Cayenne in conjunction with the optional Tiptronic S.

VarioCam Plus.

With VarioCam Plus, it's like the Cayenne had two engines, one for normal driving and another for performance driving. By steplessly adjusting the inlet valve timing and lift, the system adapts seamlessly as driver inputs change. All functions are automatically controlled by the engine management system. All you experience is responsive acceleration and ultra-smooth running characteristics. Inlet valve timing is steplessly adjusted. To improve response when starting from cold, for example, VarioCam Plus selects the higher lift setting and retards valve timing. At medium rpm's and minimal load, the valve lift is lowered and timing advanced to minimize fuel consumption and emissions. At low engine speeds in particular, VarioCam Plus significantly improves fuel economy. To achieve maximum

power and torque, the valve lift is raised and the timing advanced.

Overall, the system enhances performance while helping optimize fuel consumption.

Standard on the Cayenne S and Cayenne Turbo.

Variable-valve timing.

The V6 engine in the Cayenne features variable-valve timing on both inlet and exhaust. The camshaft phase angles are continuously varied by the

engine management system via rotary-vane adjusters.

On the new Cayenne S Hybrid, the inlet valve timing is continuously adjusted.

The key benefits include better fuel economy and lower emissions. It also helps to generate greater power and torque—even at low engine speeds.

Standard on the Cayenne and Cayenne S Hybrid.



Higher compression means higher performance.

Direct Fuel Injection (DFI).

DFI injects fuel directly into the combustion chamber at up to 1,740 psi, with millisecond precision using electromagnetic injectors. The injector position and spray geometry have been carefully designed to improve output, torque, fuel economy and emissions. The swirling of the fuel as it enters each chamber increases the mixing of air and fuel, thereby enhancing combustion. By forming the air/fuel mixture directly in the combustion chamber, DFI contributes to engine cooling. As a result, it was possible to increase the compression ratio and, therefore, power and efficiency.

Cooling systems.

Keeping cool is essential to any engine. A high-performance engine can only maintain its maximum capability over a long service life if all components are operating consistently within a specific temperature range. The engines in the new Cayenne models are therefore designed for optimal cooling.

The V8 engines have an enhanced coolant management system offering effective temperature control throughout the engine. While 20 percent of coolant flows longitudinally through the crankcase, the remaining 80 percent serves the cylinder heads using the proven cross-flow principle (from hot to cold).

On all Cayenne models, the piston heads are cooled using oil-spray jets integrated within the main lubrication system. In addition, thermal management ensures that the optimal operating temperature for the engines is reached more quickly. This keeps emissions and fuel consumption low, even when starting from cold.

The entire cooling system is designed for prolonged heavy-duty use, such as off-road driving or heavy towing applications.

Lubrication.

The V8 engines use integrated dry-sump lubrication to help ensure a consistent supply of oil in load conditions, especially in off-road terrain. The oil reservoir is located inside the engine. This saves space and reduces weight.

Oil is circulated around the V8 engines using a demand-driven pump. This has been designed for the toughest driving scenarios on- and off- road, including performance driving and off-road.

The V6 engine in the Cayenne has a wet-sump lubrication system. This helps ensure a reliable supply of oil, even under challenging driving conditions.



Air-intake system.

The Cayenne models are all equipped with a resonance air-intake system. This technology uses the pressure waves generated by the inlet valves to “force” air into the engine.

The effect is enhanced in the new Cayenne and new Cayenne S by a two-stage intake manifold. This variable geometry combines all the benefits of a long intake tube (higher torque at low rpm) with those of a shorter length (more power at higher rpm).

The effect is literally breathtaking, with highly impressive torque ratings achieved across the entire engine speed range.

Turbocharging system in the new Cayenne Turbo.

In the new Cayenne Turbo, the engine is assisted by twin turbochargers arranged in parallel—one for each bank of cylinders. Incoming air is passed through a filter and compressed by the turbine units. Its temperature is then reduced in the twin intercooler system, which improves cylinder charging and limits thermal loads on the engine.

Supercharging system in the new Cayenne S Hybrid.

The 3.0-liter V6 engine in the new Cayenne S Hybrid is fitted with a supercharger. Why? For a more direct response, even at low revs and road speeds. This is particularly useful when driving in city traffic. The supercharger has a low-temperature water-cooling system for cooling the charge air.

Electronic engine management.

To provide comprehensive engine control, the electronic engine management system continually monitors the relevant input data from a variety of sophisticated sensors. This data is then compared with a corresponding set of reference values. Based on this information, a range of key engine functions, such as ignition timing and the timings and quantities of the injections, is seamlessly and automatically adjusted. Other major functions include automatic compensation for changes in fuel quality, and control of the variable-resonance intake manifold geometry. On the new Cayenne Turbo, the engine management system also regulates the turbo boost pressure. The result is optimal fuel economy and lower CO₂ emissions, as well as greater power and torque at all times.

Exhaust system.

The lightweight exhaust systems in the new Cayenne models are made from special long-life stainless steel. The key features of the catalysts are high efficiency, faster warm-up and a long service life. The sport exhaust system,¹ available as an option on the new Cayenne and new Cayenne S, provides an even more distinctive sound. The package also includes specially designed dual-twin tailpipes.



Tailpipes on the Cayenne, Cayenne S and Cayenne S Hybrid



Tailpipes on the Cayenne Turbo



¹Introduction planned for 09/2010. For the new Cayenne, only available in conjunction with Tiptronic S.

Precision control.
Whatever your choice of terrain.

Transmission.

Six-speed manual gearbox.

The six-speed manual gearbox on the new Cayenne has been specifically adapted for the demands of high-performance use. The gear lever throw is short and precise, and each of the six ratios has been selected for optimal progression through the gears. As the center console rises to meet the dashboard, the gear lever is close at hand—for an even more engaging drive.

The standard upshift indicator in the instrument cluster helps to reduce fuel consumption still further.

Eight-speed Tiptronic S with Auto Start Stop function is also available as an option on the Cayenne.

Standard on the Cayenne.

Eight-speed Tiptronic S.

The new eight-speed Tiptronic S features a particularly wide ratio spread. First gear is designed for optimal acceleration when pulling away, and greater performance when tackling ascents and towing loads in

off-road terrain. Top speed is reached in 6th gear. The two upper gears are used to lower the revs at high speed, thereby enhancing fuel economy and occupant comfort. On the highway in particular, driving at low rpm's will significantly reduce the noise level inside the vehicle.



Tiptronic S gear selector



In automatic mode, the driver can influence gearshifts on the Tiptronic S using the throttle and brakes alone. Tiptronic S automatically adapts the gearshift point that offers maximum fuel economy. Under heavy braking, Tiptronic S shifts down to maximize engine braking.

An electric pump is used to maintain the required pressure of the transmission fluid, e.g., to transmit high levels of torque at lower engine speeds.

The standard three-spoke multifunction steering wheel in conjunction with Tiptronic S has two ergonomic switches for manual gear changes. One press forward with the thumb and Tiptronic S shifts up. One pull backward with the index finger and Tiptronic S shifts down. Either the right- or left-hand switch can be used. Naturally, you can also change gear using the gear selector lever on the center console.

Standard on the Cayenne S, Cayenne S Hybrid and Cayenne Turbo. Optional for the Cayenne.

Intelligent, discreet, responsive.
The ideal traveling companion.

Porsche Traction Management (PTM) on the new Cayenne, Cayenne S and Cayenne Turbo.

Porsche Traction Management (PTM) is an active all-wheel-drive system with an electronically variable, map-controlled multi-plate clutch, Automatic Brake Differential (ABD) and Anti-Slip Regulation (ASR).

Torque is distributed between the front and rear axles by means of the electronically variable multi-plate clutch. For the toughest off-road terrain, the differential can be locked using the PTM control on the center console. With the aid of onboard sensors, the status of the vehicle is continuously monitored and the front/rear split is adjusted to match changing driving conditions. The sensors are used to collect a range of

data, including the rotational speed of all four wheels, the lateral and longitudinal acceleration of the car, and the current steering angle.

If, for example, the rear wheels threaten to lose traction under acceleration, a greater proportion of drive torque is automatically transmitted to the front axle by a more positive engagement of the

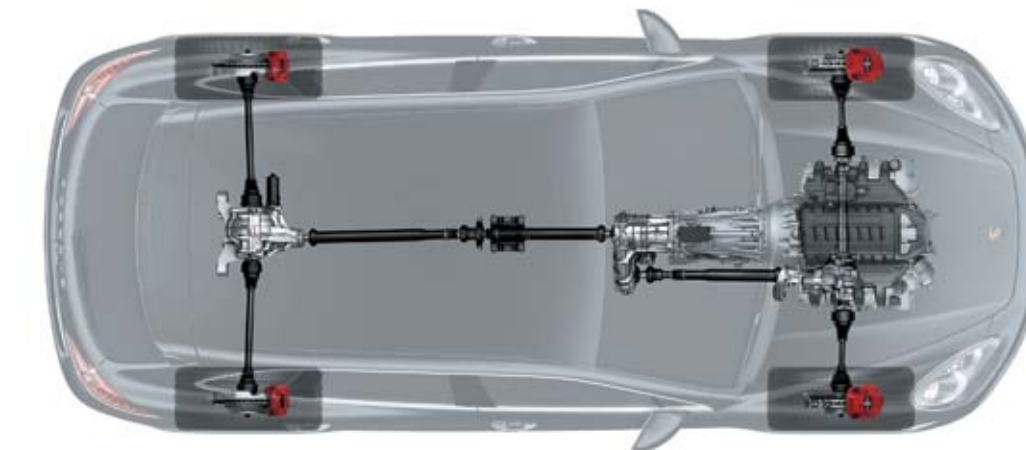

All-wheel drive on the Cayenne, Cayenne S and Cayenne Turbo

multi-plate clutch. In addition, ASR minimizes wheelspin. During cornering, the optimal level of engine torque is distributed to the front wheels to ensure excellent lateral stability.

In conjunction with advanced Porsche Stability Management (PSM, p. 56), PTM helps to ensure the perfect distribution of drive torque for optimal traction in most road scenarios, whether

on long straights, through tight corners, or on surfaces with different friction coefficients. If one of the wheels is about to lose traction, PTM uses the ABD function to apply the corresponding brake. As a result, more drive is automatically transferred to the opposite wheel. If both wheels on one axle are in danger of slipping,

ASR immediately intervenes and modifies engine output to maintain drive. As well as enhancing traction and active safety, Porsche Traction Management (PTM) offers exceptional handling and driving dynamics.

Standard on the Cayenne, Cayenne S and Cayenne Turbo.



Porsche Traction Management (PTM) on the new Cayenne S Hybrid.

The new Cayenne S Hybrid features a permanent all-wheel-drive system with self-locking center differential. This provides a standard torque split of 58 percent to the rear and 42 percent to the front. If one of

the wheels is losing grip, the self-locking center differential transmits the torque to the axle offering the highest level of traction. The ASR and ABD systems work in the same way as in the PTM on the new Cayenne, Cayenne S and Cayenne Turbo.

On the Cayenne S Hybrid, PTM also enables variable distribution

of engine torque between the rear wheels, thereby enhancing steering precision and driving dynamics. Specifically, this means that when the vehicle enters a corner at high speed, moderate brake pressure is applied to the inside rear wheel. This supports the steering motion of the vehicle, thereby improving its cornering dynamics.

Standard on the Cayenne S Hybrid.



Porsche Hill Control (PHC).

A standard feature on all new Cayenne models, Porsche Hill Control (PHC) provides downhill assistance by maintaining a

constant rate of speed on extreme downhill gradients. It is activated via a switch on the center console. The speed can be set to between 2 and 19 mph.

From asphalt jungle to off-road trail.
The new Cayenne: perfectly at home on many terrains.

Off-road capability.

With intelligent all-wheel-drive technology, the new Cayenne is engineered for many kinds of terrain, from steep ascents leading to snow-covered mountain lodges to mud and gravel and everything in between. The drive systems featured on the new Cayenne models deliver exceptional torque to give the driver plenty of power in reserve to take on almost any terrain.

Operating concept.

With the help of Porsche Traction Management (PTM), Cayenne is designed to cope with even the most demanding off-road scenarios. Simply move the main off-road control on the center console forward or backward to select one of up to three off-road modes (depending on the model).

Available on the Cayenne, Cayenne S and Cayenne Turbo, this function readies the Cayenne for off-road use or reverts the setting to normal road driving.

In Off-road Mode 1, for example, the maps for all relevant systems, such as the ABS, are adapted to provide optimal traction. In addition, Porsche Hill Control (PHC) is activated

and Off-road Level is selected on vehicles featuring air suspension with PASM. If that's not enough, the air suspension can be raised further to Special Off-road Level to increase the approach/departure angle and wading depth.

Push the off-road control forward again on the Cayenne, Cayenne S and Cayenne Turbo to activate Off-road Mode 2. For even greater traction on difficult terrain, the multi-plate clutch can be fully locked.

The electronically variable rear differential on the optional Porsche Torque Vectoring Plus (PTV Plus) is integrated within the all-wheel-drive system. This automatically helps to ensure the optimal distribution

of drive torque on particularly uneven surfaces. If one of the rear wheels begins to slip, the rear differential varies the amount of torque transmitted through each driveshaft, thereby restoring traction. In Off-road Mode 3, the main off-road control fully locks the rear differential. Then both rear wheels receive the same amount of torque, regardless of surface conditions. The optional PDCC (p. 43) enables greater wheel articulation in all three modes, improving traction further.

For effective prevention of damage to the underside of the vehicle, all new Cayenne models can be equipped with optional off-road underbody protection, comprising rock

rails with integrated skid plates, a reinforced engine-bay guard, additional protection for fuel tank and rear axle, and a second towing lug.



Main off-road control

**Making headway without getting in a spin.
An approach we thoroughly support.**

Chassis.

Porsche Torque Vectoring Plus (PTV Plus).

Our famed R&D facility at Weissach has done it again: introducing PTV Plus, a new system for enhancing driving dynamics and stability. PTV Plus offers variable distribution of engine torque to the rear wheels and an electronically controlled rear differential. Depending on the steering angle, steering speed, throttle pedal position, yaw velocity and vehicle speed, PTV Plus optimizes steering response and precision by applying brake pressure to the left or right rear wheel, as required.

Specifically, this means that when the vehicle enters a corner at speed, moderate brake pressure is applied to the inside rear wheel. This transfers drive torque to the outside rear wheel, which supports the steering motion of the car, thereby improving its cornering dynamics.

At slow and medium speeds, PTV Plus considerably enhances agility and steering precision. At high speeds, during fast cornering and under wheelspin, the electronically controlled rear differential helps to ensure additional stability.

In off-road terrain, PTV Plus reduces wheelspin on the rear

wheels—even when towing heavy trailer loads. The electronically controlled rear differential can be fully locked using the off-road control on the center console.

Optional for the Cayenne, Cayenne S and Cayenne Turbo.

Porsche Active Suspension Management (PASM).

PASM is an electronic damping control system. It offers continuous adjustment of individual shock absorbers, based on current road conditions and driving style.

During performance driving or heavy off-road use, there is an increased tendency for the body to sway. PASM helps to prevent this from happening, thereby improving stability and occupant comfort. PASM has three setup modes: Comfort, Normal and Sport.

Whichever one you select, the system uses a series of sensors to monitor the movement of the body. It also gathers data on lateral acceleration, steering angle, brake pressure and engine torque, and modifies the damping force on each individual wheel in accordance with the selected mode.

PASM remains active at all times. It automatically adapts to the prevailing driving conditions, enabling greater car control and improving comfort and safety.

Optional for the Cayenne, Cayenne S and Cayenne S Hybrid. Standard on the Cayenne Turbo: air suspension with PASM.



Porsche Active Suspension Management (PASM)

**Have you got a rough idea of smooth performance?
Let us show you more.**

Air suspension.

The new Cayenne models can be equipped with an air suspension system featuring self-leveling, ride-height control and PASM—for enhanced driving dynamics and comfort. The self-leveling function maintains a constant ground clearance, which can easily be adjusted using the ride-height control on the center console:

- 1. Special Off-road Level—2.28 in. above Normal Level; max. ground clearance: 10.55 in. (Cayenne Turbo: 10.75 in.); selectable at speeds of up to 19 mph.
- 2. Off-road Level—1.10 in. above Normal Level; max. ground clearance: 9.37 in. (Cayenne Turbo: 9.57 in.); selectable at speeds of up to 50 mph.
- 3. Normal Level—Max. ground clearance: 8.27 in. (Cayenne Turbo: 8.46 in.).
- 4. Low Level—0.87 in. below Normal Level; max. ground clearance: 7.40 in. (Cayenne Turbo: 7.60 in.); automatically selected above 86 mph.
- 5. Special Low Level—1.27 in. below Normal Level; max. ground clearance: 7.0 in. (Cayenne Turbo: 7.20 in.); automatically selected above 130 mph. (Not manually selectable.)
- 6. Loading Level—2.05 in. below Normal Level; max. ground clearance: 6.22 in. (Cayenne Turbo: 6.41 in.); only selectable when vehicle is stationary.



Air suspension ride heights

Porsche Dynamic Chassis Control (PDCC).

Available as an option in conjunction with air suspension, Porsche Dynamic Chassis Control (PDCC) is an active anti-roll system that further enhances the extraordinary roadholding and precision handling of the new Cayenne models.

PDCC anticipates and significantly reduces lateral body movement when the vehicle is cornering. This is achieved with the aid of the active anti-roll bars, featuring hydraulic swivel motors on the front and rear axles. The system responds to the current steering angle and

lateral acceleration by producing a stabilizing force that counteracts the swaying force of the body.

The benefits are greater agility at every speed, more responsive steering, stable load transfer characteristics and enhanced occupant comfort. When Off-road Level is selected via a switch in the center console, this allows the two halves of each anti-roll bar to rotate further in opposition to each other. This in turn enables greater wheel articulation and helps to ensure that each individual wheel has more contact with the ground, improving traction on uneven surfaces.

Optional for the Cayenne, Cayenne S and Cayenne Turbo.



**Shed weight.
Add agility, economy and comfort.**

Weight reduction.

Weight is the enemy of performance—which is why the new Cayenne models employ an axle concept that features consistent lightweight construction, thanks to the use of new materials. You'll experience the effects in the enhanced driving dynamics of the Cayenne, lower fuel consumption and optimal occupant comfort.

Front axle.

The chassis on the new Cayenne models offers a direct response—for a more rewarding driving experience.

On the new Cayenne, aluminum now forms the wishbones on the subframe-mounted front suspension with high-mounted upper arms. This axle design

ensures accurate wheel location, greater agility and minimal interference on uneven surfaces. The subframe is secured on large elastic mountings that reduce road noise to a minimum. It is also specially constructed to increase stability, for enhanced comfort and even greater active and passive safety. In the event of an impact, the subframe deforms in a predefined manner.

Rear axle.

The rear axle features a multi-link suspension design that minimizes dive and squat under acceleration and braking, improves mid-corner stability and compensates for sudden load transfer. In short: It enables a more relaxed way of driving. It also copes well with the high-capacity towing and carrying loads that are possible with each Cayenne. And the suspension struts are angled, which allows not only for longer suspension travel, but also a deeper, wider cargo area that's easier to load.

Steering.

The steering system has been completely revised and adapted for a sportier driving style. Around the straight-ahead position, in particular, the ratio is now more direct. With the variable steering ratio and special valve settings on the power-steering system, outstanding maneuverability is ensured. The turning circle of the new Cayenne models is just 39.1 feet.

The steering column itself consists of multiple collapsing sections linked by two universal joints, and a special deformation element provides additional safety in the event of a front impact.

And for the first time, electrohydraulic power steering is used in the Cayenne S Hybrid. The demand-driven pump provides assistance to the steering only when required, thereby contributing to overall efficiency.

Servotronic.

Servotronic is a speed-sensitive power-steering system.

At higher speeds, the steering becomes firmer, and inputs are more precise, while driver comfort is maintained. At lower speeds, it enables easy maneuverability and parking.

Standard on the Cayenne S, Cayenne S Hybrid and Cayenne Turbo. Optional for the Cayenne.



It's been observed that Porsche owners are less inclined to opt for aftermarket wheels. Here's why.

Wheels.

All of the wheels for the new Cayenne models have been specifically designed to reflect the character of the car—and convey it to the road.

Standard on the Cayenne: the 18-inch Cayenne wheel. Standard on the Cayenne S and Cayenne S Hybrid: the 18-inch Cayenne S III wheel. Standard on the Cayenne Turbo: the new 19-inch Cayenne Turbo wheel.¹

A range of other wheel options in various sizes (up to 21 inches in diameter) is available for all models.

¹For details of all wheel options, see page 104.
²In conjunction with 275mm tires for the Cayenne Turbo and 265mm tires for all other models.
³Introduction planned for 07/2010.

Tires.

All tires have been optimized with regard to driving performance, handling, rolling resistance and weight. They provide great potential for reducing fuel consumption and emissions.

All Cayenne models equipped with 18-, 19-, and 20-inch wheels are equipped with all-

season tires as standard. The three basic components of the tire have been enhanced—the rubber compound, tread design and the architecture of the substructure—especially on the 19-inch all-season tires. This reduces rolling resistance and fuel consumption, while offering the same level of comfort and performance as regular all-season tires.

Summer performance tires are available at no cost.



18-inch Cayenne wheel



18-inch Cayenne S III wheel

Tire Pressure Monitoring System (TPMS).

The Tire Pressure Monitoring System (TPMS) provides early warning of a detected low or sudden drop in pressure, via the onboard computer display.

In addition, the driver can quickly and easily check the individual pressures in all four tires via the multipurpose display in the instrument cluster.

Standard on all Cayenne models.



19-inch Cayenne Turbo wheel



19-inch Cayenne Design II wheel²



20-inch Cayenne SportDesign II wheel



20-inch RS Spyder Design wheel



21-inch 911 Turbo II wheel (forged)



21-inch Cayenne SportEdition wheel³

Safety and environment

A white Porsche SUV is shown from a high-angle perspective, driving on a dark asphalt road that curves to the right. The road is bordered by a metal guardrail on the left, which overlooks a large, calm lake. The background features a forested hillside under a clear blue sky. A dotted white line runs parallel to the road, separating the headline from the rest of the page.

Porsche is always thinking about the future, and how to achieve the best possible outcomes.

Driving with foresight.
Quite literally.

Safety.

A critical safety component onboard every Porsche is the eyes of its driver. The more information the eyes receive, the faster the driver can react. Which is why the headlights on the new Cayenne models offer exceptional levels of performance.

Auto headlights.

The headlights are automatically switched on when darkness sets in or when driving through a tunnel in the daytime. Other features include an automatic switch-off and “Welcome Home”

function—when you arrive at a destination after dark, the headlights remain illuminated for a user-defined period, lighting your path from the car.

Standard on all Cayenne models.



Night design (Cayenne Turbo)



Headlight (Cayenne, Cayenne S, Cayenne S Hybrid)



Headlight (Cayenne Turbo)



Halogen headlights.

The projector-beam halogen headlights feature automatic static range control and reflection high-beam lights—for optimal illumination of the road.

Standard on the Cayenne, Cayenne S and Cayenne S Hybrid.

Bi-Xenon™ headlights with Porsche Dynamic Light System (PDLS).

The Bi-Xenon™ headlights provide more uniform illumination of the road in both low- and high-beam mode. The system features automatic dynamic range control, auxiliary halogen highbeams and integrated headlight washers.

The dynamic cornering light function swivels the headlights toward the inside of a corner, based on the current steering angle and road speed. The static cornering lights activate the auxiliary headlights in order to illuminate more of the road in tight corners and turns.

PDLS also features speed-sensitive headlight range control—for even greater safety.

Standard on the Cayenne Turbo. Optional for all the other Cayenne models.

Daytime running lights.

Fitted as standard on all new Cayenne models: LED daytime running lights. On the new Cayenne, Cayenne S and

Cayenne S Hybrid, these are arranged horizontally in the front light units, whereas on the Cayenne Turbo, each headlight unit has four LED spotlights. Daytime running lights improve safety in the daytime as they make you more visible to other road users.

Taillights.

LED technology is used for all functions on the new rear-light modules. For an ultra-fast response and greater luminance.

The high-level third brake light is integrated into the roof spoiler.

Outstanding brake performance. To the point.

Braking systems.

Porsche is known for the powerful acceleration of its sports cars. But the incredible stopping power engineered into every Porsche is equally well-known. Equipped with new braking systems, the new Cayenne models advance the science of stopping. The larger brakes offer excellent deceleration—even when the vehicle is loaded with five adult occupants, a full complement of luggage and a braked

trailer load of up to 7,716 pounds (Cayenne with manual gearbox: 5,952 pounds).

All Cayenne models have internally vented discs all around, ensuring consistent performance during heavy use. The front-disc dimensions (diameter/thickness) are 13.78/1.34 inches on the Cayenne, 14.17/1.42 inches on the Cayenne S and Cayenne S Hybrid, and 15.35/1.50 inches on the Cayenne Turbo.

All models have six-piston monobloc aluminum brake calipers at the front and four-piston equivalents at the rear.

The calipers are black on the new Cayenne, and silver on the new Cayenne S and new Cayenne S Hybrid. On the new Cayenne Turbo, they feature a striking red finish.



Standard braking system
(Cayenne)



Standard braking system
(Cayenne S)



Standard braking system
(Cayenne Turbo)



Braking is assisted by a tandem booster and large brake master cylinder. Further assistance is provided by PSM (p. 56).

The pads are equipped with individual wear sensors. When new pads are required, a warning light is illuminated in the instrument cluster.

Electric parking brake.

Manually activated and deactivated, the electric parking brake releases automatically as you drive off.

Auto-hold function.

With the Auto-hold function, you can pull away on the flat or a slope without ever rolling back. The system automatically detects when the vehicle has come to a halt on an uphill gradient. PSM then maintains the brake pressure at all four wheels for a brief period to help prevent the vehicle from moving in the opposite direction.

Recuperation.

The electronic engine management system on the new Cayenne S Hybrid controls the braking process so that when the brake pedal is actuated, as much expended energy as possible can be harnessed by the electric motor generator mode and stored in the 288-volt nickel-metal hydride (NiMH) battery. This is referred to as recuperation.

To do this, the engine management system adjusts the generator current depending on the brake pedal position, recovers as much of the kinetic energy as possible and stores it in the battery. When the pressure on the brake pedal exceeds a certain threshold, the brakes are applied.

Porsche Ceramic Composite Brake (PCCB).

Available as an option on all new Cayenne models, the Porsche Ceramic Composite Brake (PCCB) has already proven its ability to cope with the harshest requirements of the racetrack. It is available in conjunction with 20-inch wheels or larger for the Cayenne Turbo and with 19-inch wheels or larger for all other Cayenne models.

The cross-drilled discs are generously proportioned: On the Cayenne Turbo they have a diameter of 16.14 inches at the front and 14.57 inches at the rear, while on all other models they measure 15.35 inches and 14.57 inches, respectively.

The discs are made from a specially treated carbon-fiber compound that is sintered in a high-vacuum process at over 3,000°F. The resulting material is not only much harder than cast iron—it is also more resistant to heat.



Porsche Ceramic Composite Brake (PCCB)

Even at high temperatures, the thermal resistance of the PCCB disc ensures outstanding dimensional stability. The ceramic material is completely resistant to corrosion and offers excellent acoustic damping properties.

PCCB enables shorter braking distances. The pedal response is fast and precise with only moderate input required.

Excellent fade resistance ensures greater balance when slowing from high speed.

The key advantage of PCCB is a total weight savings of approximately 50 percent compared with that of equivalent cast-iron discs. By lightening the unsprung and rotating masses, you increase the handling agility and ride comfort, and reduce fuel consumption.

Optional for all Cayenne models.

**Preparing for the road ahead.
With a little help from PSM.**

Porsche Stability Management (PSM).

Porsche Stability Management (PSM) is an electronic control system that uses a range of functions—including an Anti-lock Brake System (ABS)—to help stabilize the vehicle in hazardous road scenarios. Throughout each journey, sensors monitor the direction, speed,

yaw velocity and lateral acceleration of the car. Using this information, it is possible to calculate the actual direction of travel at any given moment. If the vehicle begins to oversteer or understeer, PSM applies selective braking on individual wheels to help restore stability. If necessary, PSM can also intervene in the engine management system to temporarily modify the amount of drive transmitted to the wheels.

PSM has three additional functions that help reduce braking distances. If the throttle pedal is released suddenly, PSM automatically readies the braking system. The pressure in the brake lines is marginally increased, bringing each of the pads into light contact with the corresponding disc. If the driver goes on to apply the brakes, the calipers respond more quickly and the braking distance is reduced.



In an emergency stop when the pressure on the brake pedal exceeds a certain threshold, the Brake Assist function uses the PSM hydraulics to apply maximum braking force at all four wheels.

The optional adaptive cruise control and PSM interact to prefill the brakes. For added safety, the system also readies the brakes whenever a decreasing distance to the vehicle in front is detected.

Even if adaptive cruise control is inactive, the system registers the speed of the vehicle in front, as long as it is moving, and automatically readies the braking system. In addition, the system alerts the driver

to the decreasing distance by briefly tugging on the brakes. Within the laws of physics, PSM compensates for load transfer caused by throttle and brake inputs, up to the maximum degree of lateral acceleration. It also enhances the vehicle's driving dynamics and directional stability when accelerating on inconsistent road surfaces.

Other features include a special control strategy in the ABS for braking on loose surfaces. By briefly locking the wheels, a wedge is formed ahead of each tire, providing additional grip to help slow the vehicle on gravel- or snow-covered surfaces.

For a more involving driving experience, PSM can also be disabled, but remains active in the background.

Standard on all Cayenne models.



Saving weight. Saving lives.

Bodyshell construction.

Our ongoing development of the lightweight steel body of exemplary rigidity is a decisive factor in the enhanced passive safety of the Cayenne body.

In the event of an accident, a system of side- and cross-members at the front of the vehicle helps to channel impact energy in a safe and predetermined manner.

The interior is protected by super high-strength steel reinforcements, including side intrusion beams in each of the doors.

High strength and consistent deformation properties: two key safety requirements fulfilled by the multiphase steel used throughout the body. Thanks to a safety cage structure made from high-tech steels, the highly

resilient passenger cell offers high levels of protection.





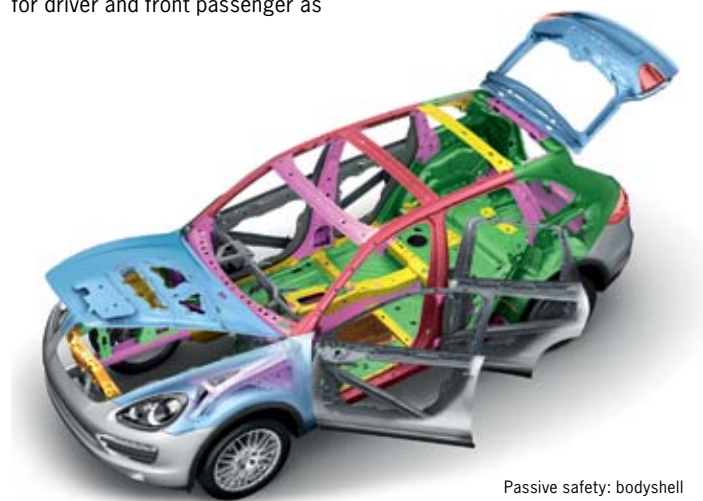

Airbags.

All Cayenne models are equipped with dual front Advanced Airbags for driver and front passenger as

standard. These are augmented by Porsche Side Impact Protection (POSIP) and a driver knee airbag. POSIP is comprised of a side airbag in each front seat, curtain-type airbags on each side of the roof—offering optimal head protection for both



Passive safety: bodyshell

 Multiphase steels	 Aluminum
 Boron-alloyed steels	 Deep-drawn steels
 Plastic	 High-strength micro-alloyed steels



Passive safety: airbags

rows of seats—and side-impact protection elements in each door. Rear side airbags are standard.*

Two impact sensors are located at the front of the vehicle to enable better detection of a head-on collision. The driver and front-passenger airbags use a gas generant based on an organic propellant. As a result, the airbags are lighter, more compact and easier to recycle. A rollover detection system provides additional protection in the event that

the vehicle overturns. Using sensor-acquired data, it enables early deployment of the curtain airbags, and triggers the seat-belt pretensioners.

Seat-belt system.

The Cayenne models feature three-point seat belts on all five seats, as well as seat-belt pretensioners (front and outer rear seats) and force limiters (front seats only).

LATCH mounting points.

The outer rear seats are equipped with the LATCH anchor system as standard. This system is specifically designed to attach the child seat directly to the rear seat of the Cayenne. Porsche child seats are available through Porsche Tequipment.

*Starting 2/2011

Reducing excess, waste and inefficiency has always been our goal.

Environment.

Since the beginning, the concept behind every Porsche has been to create the most, using the least. We are continually striving to gain performance by eliminating excess.

This is achieved by using advanced engine concepts featuring technologies such as DFI (p. 28), VarioCam Plus (p. 27), the Auto Start Stop function (p. 26), the parallel full hybrid system, and consistent lightweight construction.

Weight reduction is a key aspect of our design philosophy, derived from our rich racing heritage. Part of our R&D Center, the Motorsport Department is located in Weissach, where it shares premises with the German Automotive Industry

Exhaust Emissions Center. Just a coincidence? We call it symbiosis.

In practice: The new Cayenne is up to 408 pounds lighter, depending on the model. This was achieved through new weight-saving developments and materials, new production technologies, advanced functionalities and concept modifications. By using lighter

materials, for example, we cut the weight of the tailgate in half. New materials are also a feature of the axle construction, with steel being replaced where possible by lightweight alternatives such as aluminum and plastic.



Porsche engines.
Performing for today—and the future.

Exhaust emissions.

Whatever the class, every Porsche combines high performance with comparatively moderate emissions. On the new Cayenne models, this is achieved using advanced drive concepts—from Direct Fuel

Injection (DFI) gasoline engines to our new parallel full hybrid system. This is further aided by the rapid warm-up cycle of the catalytic converters. The optimal operating temperature is reached earlier so emissions are reduced sooner when starting from cold.

On the gasoline-engine and hybrid models, another important feature is the use of twin oxygen-sensor circuits. Each bank of cylinders has a separate control system, which the engine management system uses to establish the optimal amount of fuel—for effective emissions control.



Fuel and fuel economy.

Increasing performance while enhancing fuel economy. The new Cayenne range offers two different drive systems, each featuring state-of-the-art technology for high efficiency and relatively low fuel consumption. The gasoline engine models already operate on fuels with an ethanol content of up to 10 percent.

This further improves the carbon dioxide balance since the plants grown for the production of biofuels absorb carbon dioxide from the atmosphere. As you can see, for the benefit of the environment, we are continually working on making our cars more efficient—as well as compatible with alternative fuels. While ensuring that they remain one thing: a thoroughbred Porsche.

Fuel system.

We have also applied the highest standards in order to protect the environment from fuel evaporation. The non-return fuel supply system provides a considerable reduction in vapor emissions. The lines carrying vapor are made from multilayer plastics. A large active-carbon filter and multilayer plastic fuel tank help reduce evaporation still further.

Standard on the Cayenne, Cayenne S, Cayenne S Hybrid and Cayenne Turbo.

Noise.

It's a paradox: The distinctive Porsche sound is created in part by what you don't hear—unwanted noise. It's the result of our holistic approach to vehicle acoustics, where we optimize the sounds coming from throughout the entire vehicle, not merely the engine and exhaust.

To minimize “play” between components, we've used stronger, lighter and more temperature-resistant materials. This reduces mechanical noise. Large-volume silencers and air-intake manifolds also help to eliminate noise—throughout the life of the car.

Tire noise has been reduced with the collaboration of our official tire partners. Wind noise levels have also been lowered, thanks to aerodynamic refinements.

All that remains is a sound that is pure Porsche.

Servicing.

While service intervals for the Cayenne models are dependent on a range of factors, vehicle maintenance is kept to a minimum, thanks to long-life components and lengthy service intervals. In the case of the oil filter, for example, all that's replaced is an easily recyclable paper element. The oil-filter casing remains on the vehicle.

All moving parts inside the engine are fully self-adjusting. The valve clearances, for instance, feature automatic hydraulic control.

Thanks to single-spark coils on each of the cylinders, the entire ignition system on the gas-engined models, with the exception of the spark plugs, is maintenance-free.

These modest service requirements mean less waste disposal and fewer demands on natural resources. They also lower the cost of ownership while keeping your car on the road. As an added advantage, Porsche Cars North America offers service and maintenance packages. Please see your Authorized Porsche Dealer for details and availability.

And the new Cayenne S Hybrid doesn't require any additional regular service beyond that required of other Cayenne models.

Materials and recycling.

Owning a Porsche should be a lasting pleasure with minimal impact on the environment. This Porsche principle can be summed up in one word: sustainability. The lightweight exhaust on the Cayenne models, for example, is constructed from long-life stainless steel.

Every Porsche model is entirely free of asbestos, CFCs and components manufactured using CFCs. All legal requirements in respect of recycling are fulfilled. Materials are clearly

labeled for subsequent identification and sorting to facilitate efficient recycling.

While more than 95 percent of the car can be recycled using current technologies, the chances are your new Cayenne may never need recycling at all. After all, two-thirds of all the cars we have ever made are still on the road today.

For more information on environmental issues, please visit porscheusa.com.



Comfort and transport

Comfort starts with confidence.
Confidence is bred by design.
Ergonomic efficiency to create an
opportunity for you to lean back
and enjoy.

A familiar environment? Just like
the new Cayenne models.



Making the driver feel first among equals.

Comfort.

Like that in every Porsche, the new Cayenne interior exhibits the very highest standards of comfort and quality. And like every Porsche, it reflects our belief that the driver deserves the highest level of ergonomic design.

As you settle into the driver seat, you'll instantly sense the exceptional support. In front of you, the three-spoke multifunction steering wheel and steering column offer manual height and reach adjustment (electrically

adjustable on the new Cayenne Turbo). The steering-wheel rim is in Smooth-Finish Leather. A three-spoke sport steering wheel with shift paddles is available as an option.

And for the first time on Cayenne, five round gauges—a grouping familiar to many Porsche drivers—now form the instrument cluster, rising slightly from the dashboard as a visual unit.

Oil pressure, oil and coolant temperature as well as the fuel level are displayed using analog gauges, while the boost pressure gauge on the new Cayenne Turbo is digital. A compass display in the instrument cluster is available as an option in conjunction with PCM. This shows the four cardinal

and four ordinal directions, with degree increments as well as your current altitude.

The center console rises to meet the dashboard—a design clearly inspired by the Carrera GT.

The high-resolution 4.8-inch TFT color screen displays information from the onboard computer or, in conjunction with PCM including navigation module, map data from the navigation system. It also shows the settings of the optional adaptive cruise control

or gives various warnings, such as alerts from the Tire Pressure Monitoring System (TPMS), which is standard on all models. On the new Cayenne S Hybrid, the display also provides information about the energy management.



Cayenne Turbo with Walnut interior package in two-tone combination (Umber/Cream)

The new Cayenne places frequently used controls logically together on the center console, so selecting individual functions is quick and easy.

The rear seats provide manual fore/aft adjustment as well as backrest adjustment and a 40/20/40 split-folding feature, thereby increasing the

storage capacity from 20.5 cubic feet to 62.9 cubic feet (depending on the model).

All new Cayenne models are fitted with power windows, front and rear, with electronic door locks, remote central locking and automatic climate control. Other practical features include door storage compartments and in-door bottle holders in the front and rear.

The interior features a range of quality materials available in various combinations and comes in a choice of interior colors and finishes offering sporting style and exclusivity.

There are also a number of optional interior packages in a selection of woods or in Aluminum or Carbon Fiber. You'll find more detailed information from page 102 onward.



Porsche Crest embossed on head restraints (front)



Cayenne with Natural Olive interior package in Luxor Beige

The most important factor in our seat design: You.

8-way power seats (front).

Offering excellent long-distance comfort and intuitive operation, the front power seats feature 8-way electric adjustment including fore/aft, height, seat cushion angle and seat cushion/backrest angle settings. All seat variants come with 2-way head restraints and storage pockets on the front-seat backrests.

Driver memory package for 8-way power seats (front).

Multiple preferred settings for the driver seat, and exterior mirror positions, can be saved and restored automatically. Additional courtesy lighting in the door mirrors is also part of the driver memory package.

Optional for the Cayenne, standard on the Cayenne S and Cayenne S Hybrid.

14-way power seats (front) with memory package.

For added convenience, this seat offers electric adjustment of the front-seat positions (8-way) as well as lumbar support, seat cushion length and steering column. The memory stores

both front-seat settings, and steering-wheel and exterior mirror settings for the driver.

No-cost option on the Cayenne Turbo. Optional for all other Cayenne models.

18-way Adaptive Sport Seats with memory package.

Taking comfort and sports performance to a whole new level, the Adaptive Sport Seats with memory package feature higher, more contoured side bolsters. The additional lumbar support, the seat cushion length, side bolsters on the seat cushion and backrest, and steering column can be electrically adjusted. The package stores seat settings including lumbar support for

both driver and front passenger. The driver-side memory also stores steering-wheel and exterior mirror preferences.

Standard on the Cayenne Turbo. Optional for all other Cayenne models.

Seat/steering-wheel heating.

All seat variants are available with seat heating, either just at the front or both front and rear. Available as an option, the steering-wheel heating ensures that the wheel is pleasantly warm.

Standard on the Cayenne Turbo. Optional for all other Cayenne models.

Seat ventilation.

For even greater occupant comfort on longer journeys and in the summer, the front seats can be equipped with seat ventilation (requires seat heating and either 14-way power seats or 18-way Adaptive Sport Seats with memory package).

Optional for all Cayenne models.



14-way power seat in Natural Leather (Natural Espresso)



18-way Adaptive Sport Seat with memory package in Leather (Platinum Grey)

**The best seats in the house.
For everyone.**

Rear seats.

Styled to match the front power or Adaptive Sport Seats, the rear bench offers generous space for up to three adult passengers. For added practicality, the bench features fore/aft adjustment of 6.3 inches and a 40/20/40 split-folding seatback. The flexible center section folds down to create a load-through facility for longer items such as the optional

ski bag. The process is quite simple: unlock and fold down. It also features a folding armrest. The rear-seat backrest can be adjusted by up to six degrees: up to three degrees forward of the starting position and up to three degrees back. When it comes to being user-friendly, the new Cayenne models get right to the point—quick and easy.

Child seats.

With their unique design, Porsche child seats comply with the latest safety standards. Available from Porsche Tequipment, they have been specially tested and approved for use in Porsche

vehicles, offering comfort and safety for all passengers up to 12 years of age. All fabrics are breathable, kind to the skin and easy to clean. The covers can be removed and are washable.

All of the new Cayenne models have standard LATCH (Lower Anchors and Tethers for CHildren) mounting points on the outer rear seats. This system is specifically designed to attach the child seat directly to the seat. Porsche child seats are available through Porsche Tequipment.



Rear bench in conjunction with 14-way power seats (front) with memory package

**The perfect place to be.
And not just for the driver.**

Storage compartments.

The new Cayenne models offer a wide range of storage options. These include door storage compartments with in-door bottle holders, storage pockets on the front-seat backrests, a glove compartment cooled by the air-conditioning system, a storage compartment in the center console, and a handy drawer beneath both the driver and front-passenger seats.

Interior lighting.

The new Cayenne lights your every move. The interior includes dimmable door-handle illumination, footwell illumination front and rear, ignition lock illumination, a front light console with reading lights, as well as reading lights in the rear. This is complemented by door-entry lights front and rear, and red

door safety lights. In addition, all Cayenne models come with luggage compartment illumination and a tailgate courtesy-light function. It's an interior lighting concept that provides the required level of light whenever you need it.



Porsche Rear Seat Entertainment

Porsche Rear Seat Entertainment.

Designed to the highest standards of safety and ergonomics, the Porsche Rear Seat Entertainment blends harmoniously within the passenger compartment. Available as a factory-fitted option from Porsche Exclusive, the package¹ includes two display consoles, each with an integrated media player and

USB port, and two wireless infrared headphones. The display consoles are trimmed in matching interior leather with decorative seams and are located on the front-seat backrests. Each one contains a high-resolution seven-inch WVGA TFT color display. For greater convenience, they are swivel-mounted and feature touchscreen operation. The system is compatible with CDs and DVDs, and boasts built-in

anti-shock protection. It is also possible to connect two separate and individually selectable AV sources, such as a game console or digital camera.

Optional for all Cayenne models.



Cupholders in center console



Door storage compartment with in-door bottle holder

¹Introduction planned for 08/2010.

Sweet as it is, you may occasionally prefer the sound of something besides the engine.

CDR-31 audio system.

The new Cayenne models offer the highest levels of audio engineering.

The CDR-31 audio system has a seven-inch color touchscreen display, which enables you to navigate and select the main menus and functions with ease and efficiency.

The integrated CD radio, featuring an FM dual tuner, 30 memory presets, dynamic autostore and speed-sensitive volume control, includes a sound system with 10 loudspeakers and a total audio output of 100 watts.

Standard on the Cayenne, Cayenne S and Cayenne S Hybrid.

The CDR-31 can also be combined with the optional Bose® Surround Sound system (p. 82) or Burmester® High-End Surround Sound System (p. 84) for the ultimate in audio performance.

Other options available in combination with the CDR-31 include an integrated six-disc CD changer and XM® Satellite Radio.

Porsche Communication Management (PCM) with navigation module.

Powerful and versatile—yet easy to use—the PCM is the central control system for all information and communication functions.

Key features include a seven-inch high-resolution touchscreen display. As before, you can also operate PCM using the rotary push-button control. The menu layout is extremely clear, with no more than five entries per page, enabling fast and accurate operation. A help function is displayed at the bottom of the screen for further guidance in specific situations.

Radio functions comprise 42 presets, and an FM dual tuner.



Porsche Communication Management (PCM) with navigation module

The CD/DVD drive plays CDs and audio DVDs and is MP3-compatible. Audio playback of video DVDs is also supported. An optional integrated six-disc CD/DVD changer is available for the PCM.

A navigation module with high-speed hard drive is included with the PCM. The map display offers a bird's-eye view as well as conventional 2-D layout. In some regions, even topography and buildings can be displayed in 3-D. The remaining route is automatically adapted to the

maximum screen size. In split-screen mode, you can view the current map section together with a list of directions for the next maneuver. The system also indicates the respective speed limit for the roads covered in the database via PCM or the TFT display in the instrument cluster.

Standard on the Cayenne Turbo. Optional for all other Cayenne models.

XM® Satellite Radio.

XM® Radio provides a wide variety of entertainment in music, sports, talk, comedy and news and is now not only available for PCM, but also for the new Cayenne equipped with CDR-31. You will get superior digital sound quality on over 170 channels coast to coast, including 71 channels of commercial-free music. XM® also provides excellent sports coverage, from college sports, Major League Baseball® and the NHL® to the NBA® and PGA TOUR®. On top of all of this great programming, you can add The Best of SIRIUS® to your XM® Radio and get Howard Stern, every NFL game, every NASCAR® race, plus even more great talk, entertainment and live sports. Also available, XM® NavTraffic®¹ is the nation's first satellite-delivered traffic information service, enabling PCM's navigation module to display continually updated current traffic conditions for your desired route.

With XM® NavTraffic®¹ it is possible for drivers in 80 markets to easily access critical and customized information such as traffic congestion, accidents, incidents, road construction, average speed, and estimated driving time. All information is compiled using the best verified national and local traffic data available. It transforms your navigation system from a device you use on occasion to something you'll rely on every time you get behind the wheel. New and available for the first time on a Porsche is XM® NavWeather®¹, which displays weather data on your PCM screen, warning you of any weather threats that may otherwise spoil your drive. XM® Stocks¹ will help

you keep track of your stock portfolio's performance, and XM® Sports¹ will let you keep track of your favorite teams' scores as they happen. All delivered over the always-on, nationwide XM® network.

Required XM® Radio, XM® NavTraffic® and XM® NavWeather® subscriptions sold separately after three-month trial period. Installation costs, other fees and taxes apply, including a one-time activation fee. XM® NavTraffic® available in select markets. XM® U.S. Satellite Service is available only to those at least 18 years of age, in the 48 contiguous USA and D.C. Fees and programming subject to change. Subscriptions governed by Customer Agreement available at xmradio.com. XM® name and XM® NavTraffic® are registered trademarks of XM® Satellite Radio Inc. ©2010 SIRIUS XM Radio Inc. All other trademarks and channel names are property of their respective owners.



XM® Satellite Radio

¹Requires PCM.

Voice control.

With the optional voice control system, Cayenne puts whole-word recognition at your command—without the tedious task of voice learning. Audio prompts make voice inputs even simpler. You can also browse through lists by voice command.

Optional for all Cayenne models.



Universal audio interface

Electronic logbook.

This optional addition to PCM enables automatic recording of mileage, route distance, date and time, as well as starting location and destination of every journey. Data can be downloaded from the PCM via Bluetooth® or USB port and analyzed on a PC using software included with the package.

Optional for all Cayenne models.

Bluetooth® hands-free phone interface.

With this standard feature, you can establish a Bluetooth® connection with a mobile phone that supports the Hands-Free Profile (HFP) and use the CDR-31 audio system or PCM as a hands-free system. As a Bluetooth®-based solution, your handset can be connected without leaving your pocket. The basic phone functions are accessible via the CDR-31 or PCM. The GSM connection is established via the mobile phone antenna.

Standard for all Cayenne models.

Universal audio interface.

On vehicles with the CDR-31 audio system, an AUX-in port for a compatible MP3 player is standard. The iPod®, as well as other compatible MP3 players or memory sticks connected via USB, can be operated if Cayenne is equipped with PCM. For more information, please contact your Porsche dealer.

Standard for all Cayenne models.

An audio experience custom-engineered for the new Cayenne.

Bose® Surround Sound system.

Providing a compelling 360-degree soundstage, the Bose® Surround Sound was

custom-engineered for acoustics of the new Cayenne interior. Compatible with both Porsche Communication Management (PCM) and the CDR-31 audio

system, it features a total of 14 loudspeakers (including active subwoofer and centerfill speaker) that combine with a 585-watt 9-channel amplifier

to produce a powerful surround-sound experience.

In combination with Porsche Communication Management (PCM), the Bose® Surround Sound system enables playback of audio DVDs, making full use of the impressive sound spectrum of 5.1 digital recordings. Of course, you can still play other audio sources such as CDs or an MP3, in stereo or, at the push of a button, in one of the virtual surround

modes generated by Bose® Centerpoint® 2 technology.

The Bose®-patented AudioPilot® Noise Compensation Technology uses a microphone in the cockpit cabin to monitor ambient sound. The system is then able to provide real-time adjustment of all audio output—for a more consistent aural experience.

Standard on the Cayenne Turbo. Optional for all other Cayenne models.



Porsche Communication Management (PCM) with CD/DVD changer



Bose® loudspeaker

This is one standing ovation you'll have to give sitting down.

Burmester® High-End Surround Sound System.

The new Cayenne models are marked by exceptional versatility, with the optional High-End Surround Sound System from Burmester®. It could even be said that they offer concert-hall qualities. Once you've heard it for yourself, you'll know we are not exaggerating. Based in Berlin, Burmester® is one of the most respected premium audio manufacturers worldwide. The Burmester® High-End Surround Sound System is available as an option for all Cayenne models with CDR-31 and PCM.

The technologies behind the system meet the same exacting standards as those in the company's high-end home audio products. State of the art and featured like this in the Porsche Cayenne for the first time. The extravagance is uncompromising, the craftsmanship excellent, the sound phenomenal. The system owes its eminence to countless details, and one overriding goal: perfection in sound.

In figures: 16-channel amplifier with a total system output of more than 1,000 watts, 16 loudspeakers utilizing class A/B amplification (including active subwoofer with 300-watt Class D amplifier), a total diaphragm surface area of more than 2.5 square feet, and a frequency range of 30 Hz to 20 kHz.

Crossover technology has been carried over virtually unmodified from the company's high-end home audio systems. Analog and digital filters have been optimally defined for their new

location and finely tuned after extensive in-car audio testing.

The ribbon tweeters are ribbon-based Air Motion Transformers (AMT) offering unmistakably fine, clear and undistorted high-frequency sound reproduction with excellent level stability.

Furthermore, the elegant, purist design with galvanized surrounds and Burmester® logos on selected loudspeakers makes it clear that the appeal of the

Burmester® High-End Surround Sound System is as much about the visual as it is the audio.

Optional for all Cayenne models.



Burmester® loudspeaker

Whatever the weather, we've got you covered.

Auto climate control.

All new Cayenne models are equipped with auto climate control as standard. This system provides independent control of the temperature and air-flow volume for driver and front passenger, as well as an automatic air recirculation function with an air-quality

and humidity sensor. Other features include an active carbon filter, which excludes dust, pollen and external odors.

Four-zone climate control.

Four-zone climate control provides independent air conditioning for the rear

cabin area, with separate temperature controls for left and right. The rear climate control settings can also be adjusted from the front seats.

Optional for the Cayenne, Cayenne S and Cayenne Turbo.



Four-zone climate control for rear-seat area

Water-repellent side windows.

The front side windows on the Cayenne models have a water-repellent finish that automatically disperses moisture and dirt. The result: optimal visibility, even in poor weather conditions. (Note: Surface finish may require occasional renewal.)

Privacy glass.

All new Cayenne models are fitted as standard with privacy glass for the rear-seat and luggage area.

Standard for all Cayenne models.

Heated windshield.

For added comfort and practicality, the optional heated windshield ensures optimal visibility on cold days.

Optional for all Cayenne models.

Thermal- and noise-insulated laminated glass.

All new Cayenne models are equipped as standard with heat-insulated tinted glass featuring a grey top tint on the windshield. As an optional alternative, thermal- and noise-insulated laminated glass offers additional protection against infrared radiation and enhanced protection against noise. Enjoy peace and quiet, and an even more pleasant climate, in the passenger compartment.

Optional for all Cayenne models.



Cayenne S Hybrid with privacy glass

Inconspicuous. Unobtrusive. Indispensable.

Power sunscreen.

To protect the interior against direct sunlight, a power sunscreen for the rear side windows is available as an option. It can also be controlled from the driver seat.

Optional for all Cayenne models.

Rain sensor.

The front wiper system has two fixed speeds and an automatic rain sensor function.

Washer fluid is delivered via two heated jets, ensuring uniform coverage of the entire windshield area.

The rear wiper system is designed for maximum visibility in all conditions.

Porsche Entry & Drive.

With Porsche Entry & Drive, you can avoid the inconvenience of using a conventional key.

To enter the car, simply touch the door handle and the system automatically checks the encrypted access code on the key in your pocket. If the code is accepted, the doors are unlocked and you can step inside. To start

or stop the engine, simply turn the ignition key.

When you leave the car, all you have to do is press a button on the outside of the door handle. Porsche Entry & Drive then locks the car and arms the immobilizer.

Optional for all Cayenne models.

Anti-theft protection.

The new Cayenne models are all equipped as standard with an engine immobilizer and anti-theft alarm featuring ultrasonic interior monitoring.

The alarm circuit includes all four doors, hood, tailgate, rear window, interior, ignition and trailer (when attached). The interior monitoring can be deactivated via a switch next to the driver seat, below the seat-belt adjustment.

The immobilizer system works by automatically communicating with the vehicle key. If the key is approved, the engine will start normally.



Rain sensor



Sunscreen

**Explore the world.
In every direction.**

Electric slide/tilt moonroof.

The electric slide/tilt moonroof is made from tinted single-pane safety glass and features a manually adjustable sunscreen and remote closing function. It is operated using a control located on the roof console. As with all electric windows, an anti-jam feature is included—for added safety.

Standard on the Cayenne S, Cayenne S Hybrid and Cayenne Turbo. Optional for the Cayenne.

Panoramic roof system.

With a total surface area of more than 15 square feet, the panoramic roof system is almost four times as large as the optional slide/tilt moonroof. It consists of two glass segments. Even when closed, it provides a unique “open-top” driving experience. The panoramic view can be enjoyed from all seat positions

in every type of weather. The forward segment can be fully opened or tilted upward. An additional sunscreen protects the interior against direct sunlight.

Optional for all Cayenne models.



Electric slide/tilt moonroof



Panoramic roof system

Seeing and being seen.
It's all about having the right technology.

Driver assistance systems.

ParkAssist.

This parking aid uses an acoustic signal and front/rear displays to alert the driver of any obstacles at the front or rear of the car. Its sensors are neatly concealed in the front and rear aprons. The acoustic signal is supplemented by a visual warning in the center console display which provides a graphical representation of the vehicle's proximity to obstacles.

Standard on the Cayenne Turbo.
Optional for the Cayenne,
Cayenne S and Cayenne S Hybrid.

Rearview camera.

The rearview camera (only available in conjunction with PCM) facilitates reverse parking and maneuvering and also assists with hitching a trailer. Help is provided in the form of a high-

contrast color image with dynamic guidelines on the PCM screen, which show the predicted course of the vehicle based on the current position of the steering wheel.

Optional for all Cayenne models.



Light comfort package

Light comfort package.

Available as an option for all new Cayenne models, this package includes dimmable ambient lighting in the door panels and roof console, practical LED reading lights for the rear passengers, additional courtesy lights on the exterior mirrors on the driver and front-passenger sides, and a second 12-volt socket in the rear center console.

Optional for all Cayenne models.

Automatically dimming mirrors.

Another comfort-oriented feature: automatically dimming exterior and interior mirrors.

Standard on the Cayenne Turbo.
Optional for all other Cayenne models.

Cruise control.

Cruise control automatically regulates the speed of your vehicle for added driver comfort on longer journeys. It can be used at speeds over 20 mph and is operated using a button on one of the control stalks.

Standard on all Cayenne models.



Rearview camera



Rearview camera display in PCM



Adaptive cruise control

Adaptive cruise control.

Optional on all Cayenne models, adaptive cruise control regulates the speed of your vehicle in line with that of the vehicle driving in front. To do that, the system uses a radar sensor in the central air intake to monitor the road up to 650 feet ahead.

If you approach another vehicle that is traveling slower than your selected cruising speed, the system slows the engine or gently applies the brakes. This continues until the distance that you have preset is maintained. If heavier braking is required, the driver has to actively intervene. Your vehicle will now follow the one in front at a reduced speed.

If the other vehicle decelerates further, adaptive cruise control will continue to reduce your speed—even down to a stop. When the road ahead is free once more, the car automatically returns to your selected cruising speed of 20 mph or more. To pull away after an

automatic stop, simply press the control lever or the throttle.

For added safety, the system also readies the brakes whenever a decreasing distance to the vehicle driving in front is detected. Adaptive cruise control and PSM (p. 56) interact to prefill the brakes. The system visually and audibly alerts the driver in the event of a critical decrease in distance and briefly tugs on the brakes.

Optional for all Cayenne models.

Lane Change Assist (LCA).

Lane Change Assist (LCA) monitors the area behind the vehicle and blind spots by using radar sensors. At speeds of 20 mph or more, the system alerts the driver via a visual signal from the exterior mirrors to detected vehicles in a blind spot or those approaching quickly from behind. This enhances comfort and helps the driver, particularly when driving on the highway. However, LCA does not actively intervene in

the controlling of the vehicle and can be deactivated at any time.

Optional for all Cayenne models.



Lane Change Assist (LCA)

The Cayenne models.
For when you need to pack in a whole lot more.

Transport.

The new Cayenne brings a new facet to the concept of high performance. And it's extremely versatile too.

Luggage compartment.

The new Cayenne models have a spacious passenger area and, thanks to the adjustable rear bench, a large versatile luggage compartment. With a total volume of 23.7 cubic feet, it offers more than enough space for up to six suitcases—depending on the size. Other standard features include an easily accessible storage compartment on the left (not in the Cayenne S Hybrid) and a practical load-through facility

when the center section of the rear bench is folded down.

A Power Tailgate with a user-programmable setting that can be adjusted to the height of your garage is standard on all new Cayenne models.

With the rear seats folded, the cargo space expands to as much as 62.9 cubic feet. Items can be stored out of view and protected from the sun using a retractable cover with detachable storage cassette.

A handy ski bag is available as an option. As well as protecting the interior of your Cayenne, it can be used to transport your skis to and from the car. For added practicality, the ski bag can also be wiped clean.

Even when the car is fully loaded, the self-leveling air suspension on the Cayenne Turbo (optional on all other models) maintains a constant ground clearance at front and rear.

For greater convenience, the air suspension package includes ride-height adjustment, enabling the car to be lowered below the normal ride level for easier loading of heavy items. When moving off, the suspension automatically reverts to the standard ride-height setting (Normal Level).



Loading option



Ski bag

Cargo management system.

Partition the luggage compartment and secure individual objects during transit using a rail system with sliding telescopic bar, a fixing belt and four variable lashing eyelets. A reversible mat protects against dirt while securing luggage under braking, etc. The package also includes a cargo partition net which provides additional

safety when the car is fully loaded. The partition attaches to one of two easily accessible points on the roof liner.

Optional for all Cayenne models.



Cargo management system

Roof rails.

The high-quality roof rails¹ in Aluminum blend harmoniously with the dynamic design of the vehicle. The styling of the roof is further enhanced by a set of three drip rails included in the package. The roof rails are required for fitment of the optional Roof Transport System and come in a high-gloss black finish if equipped with the Monochrome Black Exterior Package.

Optional for all Cayenne models.

Roof Transport System.

Even when the luggage compartment is completely full, the Cayenne has space for more. In conjunction with the optional roof rails,¹ the car can be equipped with a set of lockable transverse roof bars for all the usual load-carrying attachments from Porsche. The load-bearing parts are made from aluminum and enable a maximum roof load of 220 pounds. Load-carrying attachments are available from Porsche Tequipment.

Optional for all Cayenne models.



Trailer hitch.

The Cayenne is quite simply the most versatile vehicle we have ever built. This includes the capability of being used as a tow vehicle.

All Porsche Cayenne models have trailer-hitch preparation as standard equipment.

An optional Towing Package includes a manually detachable trailer hitch that accommodates a maximum braked trailer weight of 7,716 pounds, and a maximum tongue weight of 617 pounds.²

With its exceptional towing capacity, the Cayenne takes you down the road as perhaps no Porsche ever before.

Optional for all Cayenne models.

¹Not available as a retrofit through Porsche Tequipment.
²Reduced weight for the Cayenne with standard manual transmission.

Personalization



Looking for that little bit more?
Or something different?
Create a Porsche Cayenne that
reflects your own individual style.

**Porsche always strives for efficiency.
Now that goes for getting the options you want, too.**

Introducing the Porsche Option Packages: Our most popular options, grouped to offer you more Porsche, more efficiently than ever.

You've always been able to order any available Porsche option on an individual basis. And that's not going to change. Now we're also offering select options as part of a series of packages.

Our new Option Packages make it easier to option out your Porsche in the most efficient manner and at a better cost to you, making it easier to build that Porsche you have always dreamed of.

	Cayenne	Cayenne S	Cayenne S Hybrid	Cayenne Turbo
Convenience Package				
• Bi-Xenon™ headlights with Porsche Dynamic Light System (PDLS)	<input type="checkbox"/>	<input type="checkbox"/>	<input type="checkbox"/>	
• Seat heating (front)	<input type="checkbox"/>	<input type="checkbox"/>	<input type="checkbox"/>	
• Automatically dimming exterior and interior mirrors	<input type="checkbox"/>	<input type="checkbox"/>	<input type="checkbox"/>	
• Driver memory package	<input type="checkbox"/>			
• Porsche Communication Management (PCM) with navigation module	<input type="checkbox"/>	<input type="checkbox"/>	<input type="checkbox"/>	
• Moonroof	<input type="checkbox"/>			
Premium Package Includes all of the Convenience Package and adds—				
• Servotronic	<input type="checkbox"/>			
• Porsche Active Suspension Management (PASM)		<input type="checkbox"/>	<input type="checkbox"/>	
• 14-way power seats (front) with memory package	<input type="checkbox"/>	<input type="checkbox"/>	<input type="checkbox"/>	
• ParkAssist (front and rear)	<input type="checkbox"/>	<input type="checkbox"/>	<input type="checkbox"/>	
• Heated three-spoke multifunction steering wheel	<input type="checkbox"/>	<input type="checkbox"/>	<input type="checkbox"/>	

	Cayenne	Cayenne S	Cayenne S Hybrid	Cayenne Turbo
Premium Package Plus Includes all of the Premium Package and adds—				
• Air suspension		<input type="checkbox"/>	<input type="checkbox"/>	
• Four-zone climate control				<input type="checkbox"/>
• Lane Change Assist (LCA)	<input type="checkbox"/>	<input type="checkbox"/>	<input type="checkbox"/>	<input type="checkbox"/>
• Adaptive cruise control				<input type="checkbox"/>
• Porsche Entry & Drive				<input type="checkbox"/>
• Rearview camera	<input type="checkbox"/>	<input type="checkbox"/>	<input type="checkbox"/>	<input type="checkbox"/>
• Power sunscreen for rear side windows	<input type="checkbox"/>	<input type="checkbox"/>	<input type="checkbox"/>	<input type="checkbox"/>
• Light comfort package	<input type="checkbox"/>	<input type="checkbox"/>	<input type="checkbox"/>	<input type="checkbox"/>
• Seat heating (rear)	<input type="checkbox"/>	<input type="checkbox"/>	<input type="checkbox"/>	
• Seat ventilation (front)	<input type="checkbox"/>	<input type="checkbox"/>	<input type="checkbox"/>	<input type="checkbox"/>
Sport Package				
• Three-spoke sport steering wheel with gearshift paddles				<input type="checkbox"/>
• Porsche Dynamic Chassis Control (PDCC)				<input type="checkbox"/>
• Porsche Torque Vectoring Plus (PTV Plus)				<input type="checkbox"/>
Bose® Audio Package				
• Bose® Surround Sound system	<input type="checkbox"/>	<input type="checkbox"/>	<input type="checkbox"/>	
• Six-disc changer	<input type="checkbox"/>	<input type="checkbox"/>	<input type="checkbox"/>	
• XM® Satellite Radio	<input type="checkbox"/>	<input type="checkbox"/>	<input type="checkbox"/>	

Option	Cayenne	Cayenne S	Cayenne S Hybrid	Cayenne Turbo	Code	Page
Exterior.						
• Metallic paint	○	○	○	●	Code	129
• Special colors	○	○	○	○	Code	129
• Running boards	○	○	○	○	VR1	
• Wheel arch extensions in black with side-door protection moldings	○	○	○	○	6GB	
• Stainless steel skid plate (front)	○	○	○	○	2JC	
• Stainless steel skid plates (front and rear)	○	○	○	○	2JX	
• Thermally and noise-insulated laminated glass	○	○	○	○	VW5	87
• Privacy glass	●	●	●	●		87
• Heated windshield	○	○	○	○	4GG/4GH	87
• Electric slide/tilt glass moonroof	○	●	●	●	3FE	90
• Panoramic roof system	○	○	○	○	3FU	90
• Roof rails/drip rails with matte Aluminum-Look finish (required for fitment of Roof Transport System; not available as a retrofit through Porsche Tequipment)	○	○	○	○	3S1	98
• Roof rails/drip rails with black finish (required for fitment of Roof Transport System; not available as a retrofit through Porsche Tequipment)	○	○	○	○	3S5	98
• Roof rails/drip rails with matte Aluminum-Look finish incl. Roof Transport System	○	○	○	○	5W1	98
• Roof rails/drip rails with black finish incl. Roof Transport System	○	○	○	○	5W4	98

– not available ○ extra-cost option ● standard equipment W no-cost option

Option	Cayenne	Cayenne S	Cayenne S Hybrid	Cayenne Turbo	Code	Page
Exterior.						
• Automatically dimming exterior and interior mirrors	○	○	○	●	PA2	93
• Monochrome Black Exterior Package (high-gloss)	○	○	○	○	QJ4	
• Deletion of model designation	W	W	W	W	ONA	
• Power Tailgate	●	●	●	●		96
• Tow-bar system with manually detachable tow ball ¹	○	○	○	○	1D6	99
• ParkAssist (front and rear)	○	○	○	●	7X2	92
• Rearview camera with ParkAssist (front and rear)	○	○	○	○	7X8	92
• Bi-Xenon™ headlights including Porsche Dynamic Light System (PDLS)	○	○	○	●	8EA	51
• Porsche Entry & Drive	○	○	○	○	4F6	88

¹Maximum towing capacity: 7,716 pounds.

Option	Cayenne	Cayenne S	Cayenne S Hybrid	Cayenne Turbo	Code	Page
Wheels.						
• 18-inch Cayenne wheel	•	W	W	–	C1J	46
• 18-inch Cayenne S III wheel	○	•	•	–	C1Q	46
• 19-inch Cayenne Turbo wheel	○	○	○	•	C8K	47
• 19-inch Cayenne Design II wheel	○	○	○	○	F09	47
• 20-inch RS Spyder Design wheel	○	○	○	○	CP5	47
• 20-inch Cayenne SportDesign II wheel	○	○	○	○	CN7	47
• 21-inch 911 Turbo II wheel with wheel arch extensions	○	○	○	○	CZ4	47
• 21-inch Cayenne SportEdition wheel with wheel arch extensions	○	○	○	○	CKO	47
Exclusive						
• All-season tires for 18-inch alloy wheel	•	•	•	–		
• All-season tires for 19-inch alloy wheel	•	•	•	•		
• All-season tires for 20-inch alloy wheel	•	•	•	•		
• Summer performance tires for 18-inch alloy wheel	○	○	○	–	H9K	
• Summer performance tires for 19-inch alloy wheel	○	○	○	○	H59	
• Summer performance tires for 20-inch alloy wheel	○	○	○	○	HT0	
• 21-inch Cayenne SportEdition wheel (only in exterior color)	○	○	○	○	CQ1	
• 21-inch Cayenne SportEdition wheel painted black with wheel arch extensions	○	○	○	○	CQ1	
Exclusive						
• 18-inch collapsible spare wheel (stows beneath cargo floor)	•	•	–	–	1G1	
• 19-inch collapsible spare wheel (stows beneath cargo floor) ¹	○	○	○	•	1G4	
• Tire Pressure Monitoring System (TPMS)	•	•	•	•		47
• Wheel center caps with colored Porsche Crest	○	○	○	○	1NP	

– not available ○ extra-cost option • standard equipment W no-cost option

Option	Cayenne	Cayenne S	Cayenne S Hybrid	Cayenne Turbo	Code	Page
Engine, transmission and chassis.						
• 8-speed Tiptronic S with Auto Start Stop function	○	•	•	•	G1G	32
• Porsche Torque Vectoring Plus (PTV Plus)	○	○	–	○	1Y1	40
• Servotronic	○	•	•	•	1N3	45
• Porsche Active Suspension Management (PASM)	○	○	○	–	1BZ	41
• Air suspension with Porsche Active Suspension Management (PASM)	○	○	○	•	1BK	42
• Porsche Dynamic Chassis Control (PDCC)	○	○	–	○	OAW	43
• Porsche Ceramic Composite Brake (PCCB) Disc diameter (front/rear): 15.35 in./14.57 in.	○	○	○	–	PB2	54
• Porsche Ceramic Composite Brake (PCCB) Disc diameter (front/rear): 16.14 in./14.57 in.	–	–	–	○	PB1	54
• Sport exhaust system	○	○	–	–	OP8	31
Exclusive						
• Off-road underbody protection	○	○	○	○	PT1	
• Extended range fuel tank	W	W	W	•	OM1	

¹Stows in internal holder on right-hand side of luggage compartment.

Option	Cayenne	Cayenne S	Cayenne S Hybrid	Cayenne Turbo	Code	Page
Interior.						
• Seat heating (front)	○	○	○	–	4A3	73
• Seat heating (front and rear)	○	○	○	•	4A4	73
• Seat ventilation (front)	○	○	○	○	4D3	73
• Three-spoke multifunction steering wheel	•	•	•	–	2ZM	69
• Heated three-spoke multifunction steering wheel	○	○	○	•	2ZH	
• Three-spoke sport steering wheel with gearshift paddles	○	○	○	○	1ML	69
• Lane Change Assist (LCA)	○	○	○	○	7Y1	95
• Adaptive cruise control	○	○	○	○	8T3	94
• HomeLink® (garage-door opener)	•	•	•	•		
• Rear side airbags	•	•	•	•		58
• Light comfort package	○	○	○	○	PP5/PP6	92
• Four-zone climate control	○	○	–	○	9AH	86
• Driver memory package	○	•	•	–	3L4	72
• 14-way power seats (front) with memory package ¹	○	○	○	○	PE5/Q2J	72
• Adaptive Sport Seats with memory package (18-way) ²	○	○	○	•	PE6	72
• Porsche Crest embossed on head restraints (front)	○	○	○	○	3J7	71
Exclusive						
• Porsche Crest embossed on head restraints (front and rear)	○	○	○	○	5ZF	71
Exclusive						

– not available ○ extra-cost option • standard equipment W no-cost option

Option	Cayenne	Cayenne S	Cayenne S Hybrid	Cayenne Turbo	Code	Page
Interior.						
• Roof liner in Alcantara®	○	○	○	•	6NN	
• Outer door-entry guards in stainless steel with model logo (front) ³	○	•	•	•	7M1	
• Power sunscreen for rear side windows	○	○	○	○	3Y8	88
• Floor mats	•	•	•	•	0TD	
• Non-smoker package	W	W	W	W	9JA	
• Fire extinguisher	○	○	○	○	6A7	
• Ski bag	○	○	○	○	3X1	96, 97
• Cargo management system	○	○	○	○	3GN	98
Interior: leather.						
• Partial Leather interior in standard colors, textured finish	○	○	○	○	Code	104
• Leather interior package in standard colors, Smooth-Finish Leather	○	○	○	•	Code	104
• Leather interior package in two-tone combination	○	○	○	○	Code	104
• Natural Leather interior package	○	○	○	○	Code	105
• Natural Leather interior package in two-tone combination	○	○	○	○	Code	105
• Soft ruffled leather on seat centers	○	○	○	○	N5Y/N7D/ N7F	

¹Includes electric adjustment of lumbar support, seat length and steering column; a memory package (driver side: seat, steering column, exterior mirror settings; front-passenger side: seat settings); and other additional functions.

²Includes electric adjustment of lumbar support, seat length, side cushions on backrest/seat and steering column (Cayenne Turbo: memory package as no-cost option); memory package (driver side: seat, steering column, exterior mirror settings; front-passenger side: seat settings); and other additional functions.

³"Cayenne" for Cayenne, "Cayenne S" for Cayenne S and Cayenne S Hybrid, and "Cayenne turbo" for Cayenne Turbo.

Option	Cayenne	Cayenne S	Cayenne S Hybrid	Cayenne Turbo	Code	Page
Interior packages.						
• Monochrome black interior package (high-gloss)	•	•	•	W	5TL	105
• Walnut interior package ¹	○	○	○	○	PH4	69
• Heated three-spoke multifunction steering wheel in Walnut ¹	○	○	○	○	1XJ	69
• Natural Olive interior package ¹	○	○	○	○	PH5	105
• Anthracite Birch interior package ^{1, 2}	○	○	○	○	PH6	105
• Heated three-spoke multifunction steering wheel in Anthracite Birch ¹	○	○	○	○	1XE	
• Carbon Fiber interior package	○	○	○	○	PH7	105
• Heated three-spoke multifunction steering wheel in Carbon Fiber	○	○	○	○	2FX	
• Brushed Aluminum interior package	○	○	○	•	5TE	105

Audio and communication: CDR-31 audio system.

• Bose® Surround Sound system ³	○	○	○	–	9VL	82
• Burmester® High-End Surround Sound System ³	○	○	○	–	9VJ	84
• CD changer (6-disc) ⁴	○	○	○	–	7D7	78
• Universal audio interface (AUX-in)	•	•	•	–	UF2	81
• Bluetooth® hands-free phone interface	○	○	○	–	9W5	80
• XM® Satellite Radio	○	○	○	–	QV4	
• Porsche Rear Seat Entertainment ⁵	○	○	○	–	AEC	77

Exclusive

¹Color and grain may vary.

²Ash wood in Olive grain.

³Reduced luggage compartment volume due to subwoofer beneath loadspace floor.

Cayenne S Hybrid: no storage compartment on left-hand side of luggage compartment.

⁴May be incompatible with some copy-protected CDs/DVDs.

– not available ○ extra-cost option • standard equipment W no-cost option

Option	Cayenne	Cayenne S	Cayenne S Hybrid	Cayenne Turbo	Code	Page
Audio and communication: PCM.						
• Porsche Communication Management (PCM) with navigation module and universal audio interface (AUX-in, USB, iPod®) ^{4, 7}	○	○	○	•	7T1	78
• Bose® Surround Sound system ³	○	○	○	•	9VL	82
• Burmester® High-End Surround Sound System ⁴	○	○	○	○	9VJ	84
• CD/DVD changer (6-disc) ⁴	○	○	○	○	7D7	79
• Bluetooth® hands-free phone interface ^{5, 6}	•	•	•	•	9W5	80
• Telephone module (SAP and HFP) ^{5, 6}	○	○	○	○	9W1	80
• Telephone module (SAP and HFP) with cordless keypad handset ^{5, 6}	○	○	○	○	9ZP	80
• Electronic logbook	○	○	○	○	9NY	80
• Voice control	○	○	○	○	QH1	80
• Compass display on dashboard	○	○	○	○	QR1	69
• XM® Satellite Radio	○	○	○	•	QV4	
• Porsche Rear Seat Entertainment ³	○	○	○	○	AEC	77
Exclusive						

Tourist Delivery.

• Tourist Delivery Cayenne	○	○	○	○	S9Y	112
----------------------------	---	---	---	---	-----	-----

⁵ Mobile phone preparation or telephone module in HFP mode: Using a mobile phone inside the vehicle may expose occupants to increased levels of electromagnetic radiation. The use of the telephone module for PCM via Bluetooth® SAP connection or with inserted SIM card helps to prevent exposure to this radiation as only the car's external antenna is used.

⁶ For information on compatibility with the latest iPod® and iPhone® models, please contact your Porsche dealer.



Porsche Exclusive.

Porsche Exclusive. As personal as it gets.

Over and above the personalization options featured in this catalog, you can now make your Porsche even more special with Porsche Exclusive. Have your vehicle individually and exclusively tailored to your wishes even before it leaves the factory. Aesthetically

and technically, inside and outside, using fine materials and with customary Porsche quality. Our overriding principle? Making sure that your car is uniquely handcrafted to your taste. You will find a wide range of design options in the separate Porsche Exclusive Cayenne catalog.

Your authorized Porsche dealer will be happy to answer any questions about Porsche Exclusive that you may have. Please note that delivery times may be extended for certain items of Porsche Exclusive equipment.

**Taking delivery of your Cayenne in its birthplace: Leipzig.
A truly moving experience.**

Tourist Delivery

Arrange to collect your new Cayenne directly from the Porsche factory in Leipzig where it was made, and experience the fascinating world of Porsche up close. During your five-hour visit, you'll take a detailed look behind the scenes on a tour of the factory, accompanying the Cayenne and Panamera every step of the way through this state-of-the-art production facility. Then, it's on to the Customer Centre where you will be introduced not only to the history of Porsche, but also to

the latest vehicle models. Your visit also includes a three-course meal in our restaurant, which offers spectacular panoramic views of the on-site test track.

The highlight of your factory collection is still to come. An experienced Porsche instructor will accompany you to the track and explain the finer details about your car. In a demonstration vehicle you will begin to learn about the powerful potential of the Cayenne. You can test its on-road

performance on some long straights, through hairpin bends and spectacular chicanes. Alternatively, experience the car's all-terrain capability on our dedicated off-road circuit—also under the expert guidance of one of our motorsport professionals, who will take this opportunity to explain the relevant vehicle controls and give you some useful tips. At the end of the day, to which you can bring up to two accompanying persons, it's time to take delivery of your vehicle. Fully fueled and ready to go.





Porsche Tourist Delivery

Imagine touring the original factory and then being handed the keys for an even more gratifying opportunity: touring Europe in your brand-new Porsche. What happens next is up to you. Contact your local Porsche dealer for more information.

Porsche Roadside Assistance

Your ownership experience is enhanced with complimentary enrollment in the Porsche 24-hour Roadside Assistance program. It includes coverage 24 hours a day, 365 days a year, for the duration of your warranty. Contact your Porsche dealer for specifics.

Porsche Financial Services

Competitive, convenient and carefully crafted financing options can be customized to meet your needs. Ask your certified Porsche Sales Consultant for details.

Porsche Exclusive

Realize your vision of the perfect Porsche with our factory customization program. From styling enhancements to performance upgrades, all modifications are uniquely handcrafted for your Porsche.

Porsche Tequipment

Personalize your Porsche at any time after purchase with the Tequipment range of approved accessories. Designed exclusively for your Porsche, every product is fully guaranteed.

Porsche Design Driver's Selection

Our distinctive collection of clothing and accessories combines timeless elegance with unmistakable quality. Visit your local Porsche dealer or shop online at porscheusa.com/shop.

Service

Porsche Approved Pre-Owned

Only the best Porsche cars earn the right to be called "Certified." A meticulous 111-point inspection, a 2-year or 50,000-mile Limited Warranty, and 24-hour Roadside Assistance make this program one of a kind. Contact your Porsche dealer for details.

Porsche Classic

Your specialist source for genuine Porsche parts and technical documentation, as well as servicing, repair and restoration for all types of classic Porsches. For more information visit porscheusa.com/classic.

Christophorus

Our bimonthly magazine for Porsche owners is packed with news, articles and exclusive interviews covering every aspect of Porsche automobiles and the Porsche lifestyle.

Porsche Clubs

With more than 120,000 members worldwide in 60 countries, know you are not alone in your passion for Porsche. Learn more about the brand and meet other Porsche enthusiasts just like yourself. Visit porsche.com for more information.

Porsche Driving Experience

1. Porsche Travel Club. Exclusive driving holidays and incentive ideas combining luxury and adventure, worldwide. Visit porschedriving.com for more information.

2. Porsche Sport Driving School.

Develop your skill and explore your Porsche with the Porsche Sport Driving School. Learn firsthand from famed Porsche Racing drivers while they teach you at a world-class racing facility. Visit porschedriving.com for more information.



Porsche Online

For all the latest news and information from Porsche, go to porscheusa.com.



Ask your Porsche dealer for the latest brochures from Porsche Exclusive, Porsche Tequipment, Porsche Design Driver's Selection and the Porsche Driving Experience.

Summary

When designing the new Cayenne, we decided to make it different. And therefore more Porsche than ever.

To the point.
The new Cayenne models.



Technical data

	Cayenne	Cayenne S
Engine/electric motor		
Cylinders	6	8
Displacement	3.6 liters	4.8 liters
Max. power (DIN) at rpm	300 hp 6300	400 hp 6500
Max. torque at rpm	295 lb.-ft. 3000	369 lb.-ft. 3500
Compression ratio	11.7:1	12.5:1
Max. power (electric motor) at rpm	–	–
Max. torque (electric motor) at rpm	–	–
Max. power (parallel full hybrid) at rpm	–	–
Max. torque (parallel full hybrid) at rpm	–	–

Transmission

Layout	Porsche Traction Management (PTM): active all-wheel drive with electronically variable, map-controlled multi-plate clutch, Automatic Brake Differential (ABD) and Anti-Slip Regulation (ASR)	Porsche Traction Management (PTM): active all-wheel drive with electronically variable, map-controlled multi-plate clutch, Automatic Brake Differential (ABD) and Anti-Slip Regulation (ASR)
6-speed manual gearbox	Standard	–
8-speed Tiptronic S	Optional	Standard

Chassis

Front axle	Fully independent double-wishbone	Fully independent double-wishbone
Rear axle	Fully independent multi-link	Fully independent multi-link
Steering	Power-assist, hydraulic	Power-assist, hydraulic

Cayenne S Hybrid	Cayenne Turbo
6	8
3.0 liters Supercharged	4.8 liters Twin-turbocharged
333 hp 5500	500 hp 6000
325 lb.-ft. 3000–5250	516 lb.-ft. 2250–4500
10.5:1	10.5:1
47 hp > 1150	–
221 lb.-ft. < 1150	–
380 hp 5500	–
428 lb.-ft. 1000	–

Porsche Traction Management (PTM): permanent all-wheel drive with self-locking center differential, Automatic Brake Differential (ABD) and Anti-Slip Regulation (ASR)	Porsche Traction Management (PTM): active all-wheel drive with electronically variable, map-controlled multi-plate clutch, Automatic Brake Differential (ABD) and Anti-Slip Regulation (ASR)
–	–
Standard	Standard

Fully independent double-wishbone	Fully independent double-wishbone
Fully independent multi-link	Fully independent multi-link
Power-assist, hydraulic	Power-assist, hydraulic

Some of the vehicles featured in this catalog are fitted with optional equipment available at extra cost. All information in respect of features, design, performance, dimensions, weight, fuel consumption and running costs is correct at the time of publication. Porsche reserves the right to alter specifications and other product information without prior notice.

	Cayenne	Cayenne S
Chassis		
Brakes	6-piston monobloc aluminum fixed calipers at front, 4-piston monobloc aluminum brakes at rear, ABS	6-piston monobloc aluminum fixed calipers at front, 4-piston monobloc aluminum brakes at rear, ABS
Wheels	8.0J x 18	8.0J x 18
Tires	255/55 R 18	255/55 R 18
Weights		
	Manual gearbox/Tiptronic S	Tiptronic S
Curb weight	4,398 lb./4,475 lb.	4,553 lb.
Maximum load	1,698 lb.	1,709 lb.
Towing load	5,952 lb./7,716 lb.	7,716 lb.
Performance		
	Manual gearbox/Tiptronic S	Tiptronic S
Top speed	142 mph/142 mph	160 mph
0-60 mph	7.1 secs/7.4 secs	5.6 secs
Estimated EPA fuel economy*		
	Manual gearbox/Tiptronic S	Tiptronic S
City (mpg)	15/16	16
Highway (mpg)	22/23	22

	Cayenne S Hybrid	Cayenne Turbo
Chassis		
Brakes	6-piston monobloc aluminum fixed calipers at front, 4-piston monobloc aluminum brakes at rear, ABS	6-piston monobloc aluminum fixed calipers at front, 4-piston monobloc aluminum brakes at rear, ABS
Wheels	8.0J x 18	8.5J x 19
Tires	255/55 R 18	265/50 R 19
Weights		
	Tiptronic S	Tiptronic S
Curb weight	4,938 lb.	4,784 lb.
Maximum load	1,477 lb.	1,565 lb.
Towing load	7,716 lb.	7,716 lb.
Performance		
	Tiptronic S	Tiptronic S
Top speed	150 mph	172 mph
0-60 mph	6.1 secs	4.4 secs
Estimated EPA fuel economy*		
	Tiptronic S	Tiptronic S
City (mpg)	20	15
Highway (mpg)	24	22

	Cayenne	Cayenne S
Dimensions		
Length	190.8 in.	190.8 in.
Width (incl. mirrors)	76.3 in.	76.3 in.
Height	67.4 in.	67.4 in.
Wheelbase	114.0 in.	114.0 in.
Luggage compartment volume (VDA), with rear seats folded	62.9 cu. ft.	62.9 cu. ft.
Fuel tank capacity	22.4 gal.	22.4 gal.
Off-road capability		
Ground clearance ¹	8.70 in.	8.70 in.
Maximum wading depth	19.69 in.	19.69 in.
Approach angle ²	26.5° (with standard suspension)	26.5° (steel-sprung suspension)
Departure angle ²	25.0° (steel-sprung suspension)	25.0° (steel-sprung suspension)
Ramp breakover angle ²	21.0° (steel-sprung suspension)	21.0° (steel-sprung suspension)
Maximum wading depth	19.69 in.	19.69 in.

	Cayenne S Hybrid	Cayenne Turbo
Length	190.8 in.	190.8 in.
Width (incl. mirrors)	76.3 in.	76.3 in.
Height	67.4 in.	67.0 in.
Wheelbase	114.0 in.	114.0 in.
Luggage compartment volume (VDA), with rear seats folded	59.7 cu. ft.	60.2 cu. ft.
Fuel tank capacity	22.4 gal.	26.4 gal.
Ground clearance ¹	8.70 in.	Min. 6.41 in./max. 10.75 in. with standard air suspension
Maximum wading depth	19.69 in.	21.85 in. (air suspension, normal mode)
Approach angle ²	26.5° (steel-sprung suspension)	26.0° (air suspension, special off-road mode)
Departure angle ²	25.0° (steel-sprung suspension)	24.5° (air suspension, normal mode)
Ramp breakover angle ²	21.0° (steel-sprung suspension)	20.0° (air suspension, normal mode)
Maximum wading depth	19.69 in.	21.85 in. (air suspension, normal mode)

¹At curb weight with standard suspension.

²At DIN unladen weight, ground clearance at axle center, Cayenne Turbo with air suspension. All information in respect of features, design, performance, dimensions, weight, fuel consumption and running costs is correct at the time of publication. Porsche reserves the right to alter specifications and other product information without prior notice.

Index

A

Adaptive cruise control	94
Air-intake system	30
Air suspension	42
Airbags	58
All-wheel drive	34
Anti-Slip Regulation (ASR)	34
Anti-theft protection	89
Audio systems	78–85
Auto headlights	50
Automatically dimming mirrors	93
Automatic Brake Differential (ABD)	34
Auto Start Stop function	26

B

Bluetooth®	81
Bose® Surround Sound system	82
Brakes	52
Burmester® High-End Surround Sound System	84

C

Cargo management system	98
CD/DVD changer	79
Ceramic brakes	54
Chassis	40
Child seats	74
Climate control	86
“Coast”	22
Colors	126
Comfort lighting package	92
Compass display	69
Cooling systems	28
Cornering lights	51
Cruise control	93

D

Daytime running lights	51
Direct Fuel Injection (DFI)	28
Downhill assistance—	
Porsche Hill Control (PHC)	37
Driver memory package	72

E

Electric machine	20
Electronic logbook	81
Engine management (electronic)	31
Engines	20
Environment	60
Exhaust emissions	62
Exhaust system	31
Exterior	102

F

Fuel economy	62
Fuel system	63

H

Headlights	50
Heated windshield	87
Hybrid module	14

I

Ignition system	64
Interior	68, 106, 128
Interior lighting	76
Interior safety features	58

L

Lane Change Assist (LCA)	95
Lighting	50
Lightweight construction	58
Loading options	96
Lubrication	29
Luggage compartment	96

M

Manual gearbox	32
Materials	65
Memory package	72
Mobile phone preparation	80
Moonroof	90
MP3	79, 81, 83
Multifunction steering wheel	33

N

Navigation system	78
Off-road capability	38
Onboard computer	69

P

Panoramic roof system	90
Parallel full hybrid	14
ParkAssist	92
Parking brake (electric)	53
Personalization	100
Porsche Active Suspension Management (PASM)	41
Porsche Ceramic Composite Brake (PCCB)	54
Porsche Communication Management (PCM)	78
Porsche Dynamic Chassis Control (PDCC)	43
Porsche Dynamic Light System (PDLS)	51
Porsche Entry & Drive	88
Porsche Rear Seat Entertainment	77
Porsche Side Impact Protection (POSIP)	58
Porsche Stability Management (PSM)	56
Porsche Torque Vectoring Plus (PTV Plus)	40

O

Off-road capability	38
Onboard computer	69

Porsche Traction Management (PTM)	36
Privacy glass	87

R

Radio	80
Rain sensor	88
Rearview camera	92
Recuperation	54
Recycling	65
Roof Transport System	98

S

Safety	48
Seat-belt system	59
Seats	72
Self-leveling	42, 96
Servicing	64
Servotronic	45
Sport exhaust system	31
Steering	45
Storage compartments	76
Sunscreen	88
Supercharging system	30

T

Tailgate (automatic)	96
Taillights	51
Technical data	116
Telephone module	81
Thermal- and noise-insulating glass	87

Tiptronic S	32
Tire Pressure Monitoring System (TPMS)	47
Touchscreen	78
Tourist Delivery	111
Tow-bar systems	99
Transmission	32
Turbocharging systems	30

U

Universal audio interface	81
USB port	81

V

Variable-valve timing	27
VarioCam Plus	27
Voice control	80

W

Water-repellent side windows	87
Weight reduction	44
Wheels	46

Colors

Colors can affect people in very different ways. That's why the new Cayenne models come in an extensive color range with no fewer than 11 exterior shades. In total, there's a choice of two solid, seven metallic and two special colors. You can also choose from five interior colors and four two-tone combinations, as well as six interior packages in Aluminum, Carbon Fiber or a selection of fine woods.

To see how these color options would look on your car, use the Porsche Car Configurator at [porsche.com](https://www.porsche.com). Design a Porsche Cayenne that uniquely reflects your own individual style. Inside and out.

Standard interior colors. Dashboard/trim/seats.



Black



Platinum Grey

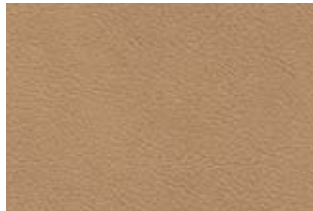

Luxor Beige⁴

Standard colors: leather interior. Dashboard/trim/seats.



Black



Platinum Grey



Luxor Beige

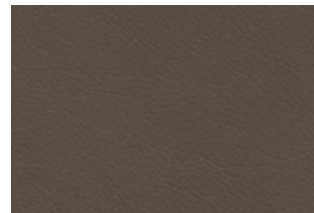

Umber

Two-tone combinations: leather interior. Dashboard/trim/seats.

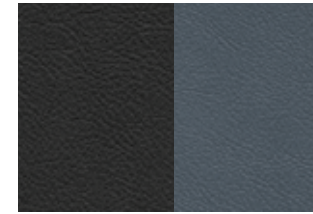

Black/Titanium Blue
(roof liner: Black; carpet¹: Titanium Blue)



Umber/Cream
(roof liner: Umber; carpet¹: Cream)

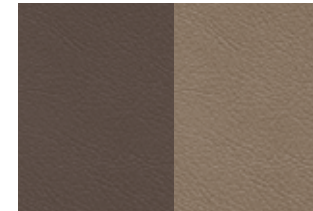

Umber/Light Tartufo
(roof liner: Umber; carpet¹: Light Tartufo)

Natural leather interior. Dashboard/trim/seats.



Natural Espresso

Two-tone combination: natural leather interior. Dashboard/trim/seats.



Natural Espresso/Cognac
(roof liner: Natural Espresso; carpet¹: Cognac)

¹Carpet in loadspace area in darker color..

Interior Packages.



Walnut.^{1, 2}



Natural Olive¹



Brushed Aluminum



Anthracite Birch^{1, 2}

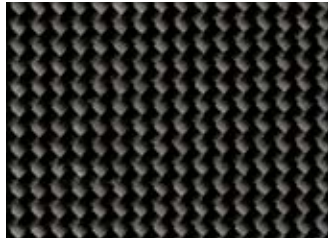

Carbon Fiber²



Monochrome Black (high-gloss)

Solid exterior colors.

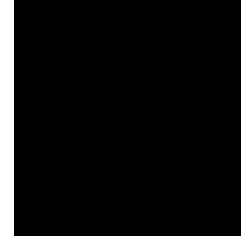

Black

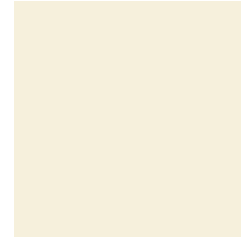

Sand White

Metallic exterior colors.

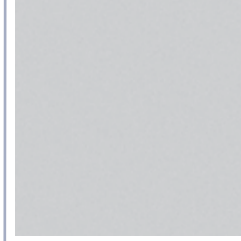

Classic Silver Metallic



Meteor Grey Metallic



Jet Black Metallic



Umber Metallic

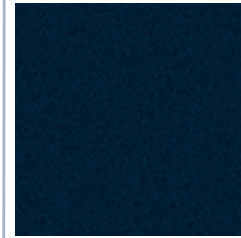

Dark Blue Metallic



Jet Green Metallic

Special exterior colors.

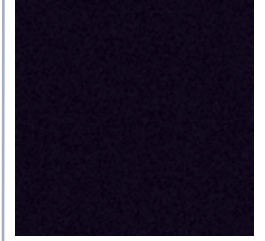

Auburn Metallic

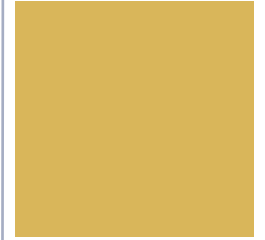

Sand Yellow



Amethyst Metallic

²Color and grain may vary.
³Also available on steering wheel.
⁴Ash wood in grain "Olive."