

MKT 001 205 11



Porsche Cars North America, Inc.
980 Hammond Drive, Suite 1000
Atlanta, Georgia 30328



Dr. Ing. h.c. F. Porsche AG is the owner of numerous trademarks, both registered and unregistered, including without limitation the Porsche Crest®, Porsche®, Boxster®, Carrera®, Cayenne®, Cayman®, Panamera®, Speedster®, Spyder®, Tiptronic®, VarioCam®, PCM®, PDK®, 911®, 4S®, 918 Spyder™, FOUR, UNCOMPROMISED.®, and other model names and numbers, and the distinctive shapes of the Porsche automobiles, such as the federally registered 911 and Boxster automobiles. The third-party trademarks contained herein are the properties of their respective owners. Porsche Cars North America, Inc., believes the specifications to be correct at the time of printing. Specifications, performance standards, standard equipment, options, and other elements shown are subject to change without notice. Some options may be unavailable when a car is built. Some vehicles may be shown with non-U.S. equipment. Please ask your dealer for advice concerning the current availability of options and verify the optional equipment that you ordered. Porsche recommends seat-belt usage and observance of traffic laws at all times.

All fuel consumption and emissions data contained herein are derived from U.S. tests and were accurate at time of press.

©2011 Porsche Cars North America, Inc. Printed in the U.S.A. MKT 001 205 11 porscheusa.com 1-800-PORSCHE

The Panamera

The Panamera



Concept	3
The Panamera model range	5
Panamera and Panamera 4	19
Panamera S and Panamera 4S	23
Panamera S Hybrid	25
Panamera Turbo and Panamera Turbo S	27
Performance	31
Engines	33
Transmission	47
Chassis	55
Balance	73
Environment	79
Personalization	85
Comfort	87
Colors	117
Personalization	118
Porsche Tourist Delivery	138
Service	139
Summary	141
Technical data	143
Index	151
Colors	153



Concept

The Panamera models. Four-doors. Four-seats. Sports car technology for four. Comfort and everyday practicality without compromise. Efficient drive concepts, a lightweight body, and highly dynamic. This is the principle of "Porsche Intelligent Performance."

Sports car technology for four.

The Panamera model range.

Ask Porsche engineers for a solution, and they will start at the beginning. The brief did not specify a sedan. Nor did it specify a four-seater, or even an all-wheel drive. It specified a Porsche.

The first car to bear the Porsche family name rolled out of a modest workshop in Gmünd, Austria, in 1948. Back then, there had never been a sports car that looked anything like Porsche No. 1. With its efficient engineering, it defied the conventional wisdom of automotive design. And with its pure, unadorned form, it refused to follow the fashion of the day.

That DNA is deeply embedded in the Panamera models. Designed to accommodate four adult occupants in truly spacious comfort, the Panamera is unlike any other automobile with four doors because a Porsche is

fundamentally different from all other automobiles, period.

In the way it accelerates, steers, handles, and stops, the Panamera is what every Porsche has always been: a pure sports car, built from the ground up, to fulfill a standard of performance that separates Porsche from the competition—be it on a racetrack or the showroom floor.

Where conventional car companies take a four-door sedan and add on to it higher levels of horsepower and torque, bigger brakes, wider wheels, bolstered seats, a leather shift knob, and a larger, louder exhaust, Porsche developed the Panamera from an entirely different starting point: the collective knowledge gained from six decades of building sports cars.

We believe it's about the pure driving experience, regardless of whether you sit in the front or the back. It's about four doors and four seats in a Porsche. Sports car technology for four.

The Panamera.
 The Panamera 4.
 The Panamera S.
 The Panamera 4S.
 The new Panamera S Hybrid.
 The Panamera Turbo.
 The new Panamera Turbo S.





turbo

Panamera S

Panamera S

Panamera

Panamera S

Hybrid

PORSCHE
Panamera Turbo S
turbo S

**If you loved the road,
you wouldn't dream of tarnishing it.**

Exterior design.

As you can see, we didn't experiment with the car's design. We stuck with our philosophy that form should follow function. Nothing else would have made sense. Nothing else would have produced a four-seater Porsche.

How can you tell whether it has the Porsche DNA? From the distinctive proportions and lines. The fenders are slightly higher than the hood and, at the rear, they are distinctly muscular and form the typical Porsche shoulder line. The silhouette of the Panamera models is therefore classically Porsche. It is dynamic without being overbearing, and exudes elegance rather than extravagance.

The front, shoulders, and rear all have instantly recognizable Porsche traits. Particularly striking are the side air outlets behind the front wheels—paying homage to the Carrera GT.

A low, wide stance. A sleek roofline. The overall impression leaves you with no doubt that these are true Porsche sports car proportions.

The most striking aspect of the rear is undoubtedly the spoiler, which is integrated into the rear lid. From a speed of around 55 mph, it deploys automatically. However, on the Panamera Turbo models, it doesn't stop there. The spoiler splits in the middle and extensions deploy to the left and right, making it considerably wider to further reduce lift at the rear axle.

The classic sports car design of the wheels is fine-spoked, lightweight, and stylish. Sizes range from 18 inches to 20 inches, and all the wheels provide a good glimpse of the brake system. Just another example of performance styling.

The appearance of all models can be customized to your individual taste. The color palette offers no fewer than 16 exterior colors. In total, there are two solid, nine metallic, and five special colors to choose from. An additional metallic color, Agate Grey Metallic, is available for the Panamera Turbo S. On request through the Porsche Exclusive program, you can opt to have your Panamera model finished in practically any color of your choice. In addition, a wide range of personalization options is available.

Compromise, you see, is simply not acceptable to our engineers. Or, for that matter, to our customers.

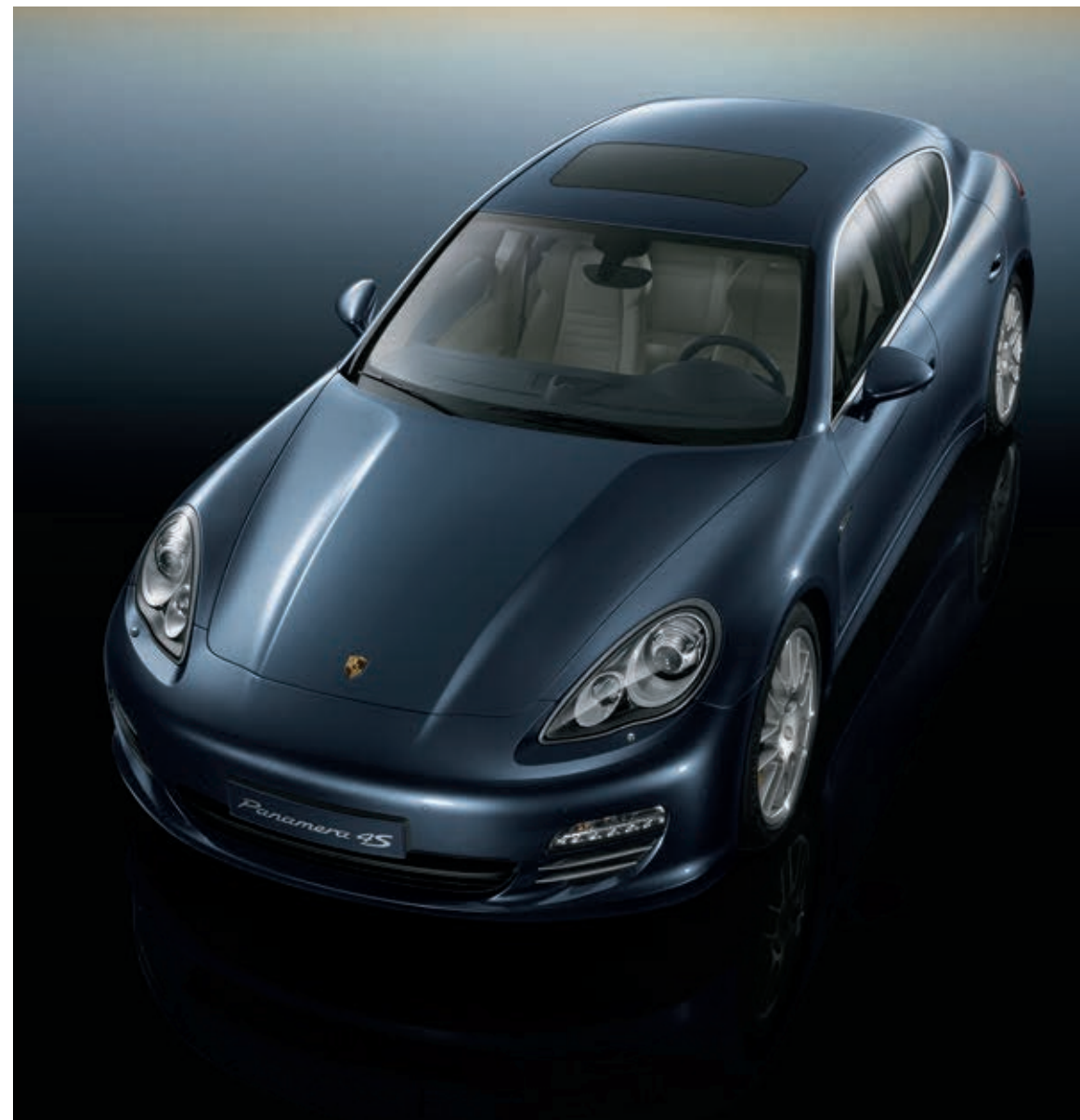

There are times when everyone deserves a door, and a seat, of their very own.

Interior design.

Whatever kind of journey you are making—short or long, for business or pleasure, or even just routine driving—the Panamera offers something a little bit different.

When you sit inside one of the new Panamera models, four things immediately stand out:

first, the ascending center console; second, the four individual seats; third, the amount of space in the rear, where even taller passengers will find plenty of legroom and headroom; and fourth, the versatility of the luggage compartment, thanks to the folding rear seats.

The ignition is, of course, located on the left-hand side of the steering wheel, as in all Porsche vehicles. Among the five circular instrument dials is the tachometer, just where all Porsche drivers expect it to be: in the center.

The four individual seats (p. 91) are comfortable and offer good lateral support. In conjunction with seat heating, a seat ventilation function is also available as an option. The 8-way power seats in the rear (p. 93) are another special feature available as an option.

Why four individual seats? Because only these satisfy our rigorous demands for high-performance driving. The conventional rear bench seat could not fulfill these requirements and instead made way for a center console.



If you regularly spend time as a passenger in the back, you can customize your surroundings with a range of optional equipment and packages, such as the large center console, the roll-up sunblinds for the rear side windows and behind the rear compartment, or the rear interior lighting package.

The preserve of the premium class: the comprehensive range

of personalization options, with seven interior colors, five two-tone combinations, and two additional two-tone combinations exclusively for the Panamera Turbo S. Plus a range of optional interior packages featuring fine woods, Carbon Fiber, or Aluminum.

If you suspected that the Panamera is more than just a sports car with four seats,

this is confirmed by a glance inside the luggage compartment (p. 111). Under the large rear lid, there is space to accommodate four suitcases from the Porsche Design Driver's Selection. Enough room for a trip with four occupants.



Does your head tell you that pleasure and efficiency are mutually exclusive?

Listen to your heart instead.

The Panamera and the Panamera 4.

So, you have duties to perform, but who says that you cannot follow your heart and combine practicality with pleasure at the same time? For us, this is intelligent overall performance.

The distinguishing features of the Panamera and Panamera 4 are the 18-inch Panamera wheels, black brake calipers, and twin single-tube tailpipes. Side windows have matte-black borders.

The double slats on the side air intakes are black on the Panamera and titanium-colored on the Panamera 4.



Panamera



Panamera 4

The Panamera and Panamera 4 are equipped with the 3.6-liter, naturally aspirated V6 engine. Efficient and sporty, thanks to Direct Fuel Injection (DFI, p. 44) and VarioCam Plus (p. 45) fitted as standard, it generates 300 horsepower and 295 lb.-ft. of torque.

On the Panamera, power is transmitted to the rear axle by the 7-speed Porsche Doppelkupplung (PDK, p. 47) with Auto Start Stop function (p. 43). This double-clutch transmission enables fast gear changes with no interruption in the flow of power, for increased performance and greater comfort but lower fuel consumption.*

*Please see fuel economy estimates on pages 147-150.



Panamera 4 with 19-inch Panamera Design wheels, Panamera with 20-inch 911 Turbo II wheels

On the Panamera 4, the standard active all-wheel drive of Porsche Traction Management (PTM, p. 53) and the 7-speed Porsche Doppelkupplung (PDK) with Auto Start Stop function inspire a confident drive.

The steel spring suspension is standard on both models, offering a high level of comfort combined with a sporty setup. Porsche Active Suspension Management (PASM, p. 59) or

adaptive air suspension with PASM is available on request.

Also standard is Porsche Stability Management (PSM, p. 63), which helps maintain stability during dynamic driving performance, delivering better traction and increased safety.

With the weight of these models as low as 3,880 pounds, driving pleasure is simply inevitable.

The figures speak for themselves: The Panamera accelerates from 0–60 mph in 6.0 seconds, with a top track speed* of 160. With the optional Sport Chrono Package Plus, 0–60 mph is an even more impressive 5.8 seconds. The Panamera 4 completes the 0–60 mph sprint in 5.8 seconds and has a top track speed* of 159 mph. With Sport Chrono Package Plus, 0–60 mph is 5.6 seconds.

The interior offers plenty of comfort and lots of space. The two individual seats in the rear compartment fold separately or jointly, increasing luggage capacity to 44.6 cubic feet. Automatic climate control is standard. Three interior colors are available for the Partial Leather interior. The seat surfaces, inner backrest surfaces and side bolsters, door handles, door armrests, and armrest section of the

center console are finished in embossed leather, while the gear selector and steering-wheel rim are in Smooth-Finish Leather.

The sport steering wheel, black dial faces, and interior trims in high-gloss black add to the interior's visual appeal.

Porsche Communication Management (PCM, p. 96) with navigation module is standard, with the Bose® Surround Sound System (p. 101)

and the Burmester® High-End Surround Sound System (p. 103) available as options.

The Panamera and Panamera 4 offer the best of both worlds: performance and practicality. They are comfortable, luxurious, perfect for long journeys, and every bit a Porsche.

*Top track speed is achieved when vehicle is equipped with optional summer tires with adequate speed rating.

**Four doors.
But a classic sports car nonetheless.**

The Panamera S and the Panamera 4S.

Your lifestyle demands a vehicle that is practical. Your heart desires a sports car. The Panamera S and 4S. Four-seaters with driving dynamics and performance figures to match a sporty two-seater.

The S models are recognizable by the silver-colored brake calipers behind the 18-inch Panamera S wheels and by their round twin tailpipes.

The side windows have a chrome-colored border. In the interior, the silver-grey tachometer is visually striking.

On the Panamera S, the double slats on the front side air intakes are black. On the Panamera 4S, they are titanium-colored.

Both models have a 4.8-liter, naturally aspirated V8 engine that produces 400 horsepower

and 369 lb.-ft. of torque. On both the Panamera S and the Panamera 4S, the 7-speed Porsche Doppelkupplung (PDK) is the standard transmission. The active all-wheel-drive Panamera 4S combines PDK with Porsche Traction Management (PTM, p. 53) for an enhanced driving experience.

The Panamera S accelerates from 0–60 mph in just 5.2 seconds,

with a top track speed* of 175 mph. With the optional Sport Chrono Package Plus, 0–60 mph is achieved in 5.0 seconds.

The Panamera 4S completes the sprint in only 4.8 seconds and has a top track speed* of 175 mph. Add Sport Chrono Package Plus and the acceleration is in 4.6 seconds.

Steel spring suspension with Porsche Active Suspension Management (PASM, p. 59) is standard in both models. Adaptive air suspension, 20-inch wheels, and a sport exhaust system are just three of many options you can select.

Additional standard features include Bi-Xenon™ main headlights with dynamic range adjustment (p. 71), which provide more effective illumination of the road, the Tire Pressure Monitoring System (TPMS, p. 58), and automatically dimming exterior and interior mirrors.



Panamera 4S with sport exhaust system and 20-inch RS Spyder Design wheels

A high level of interior comfort is assured by the automatic climate control system and seat heating as standard in the front, with seat heating optional for the rear. Seat ventilation is available on request. The Partial Leather interior has the same specification as for the Panamera/Panamera 4.

Standard in the Panamera S and Panamera 4S is the Porsche Communication Management

(PCM) with navigation module. The Bose® Surround Sound system (p. 101), the Burmester® High-End Surround Sound System (p. 103), and SiriusXM Satellite Radio™ are available as options in conjunction with PCM.

These options are only the beginning when it comes to customizing the Panamera S or 4S. Give your four-seater Porsche your very own personal touch.



Panamera S

*Top track speed is achieved when vehicle is equipped with optional summer tires with adequate speed rating.

A 380-hp hybrid.

The next evolution of Porsche Intelligent Performance.

The new Panamera S Hybrid.

With the Panamera, we've already taken a fairly radical step—the creation of a sports car that can accommodate four people in comfort. The next step is to blend performance driving pleasure with—what else—hybrid technology. Introducing the new Panamera S Hybrid.

So what makes the new Panamera S Hybrid so special? Above all, it's the parallel full hybrid drive: a 3.0-liter, supercharged V6 engine with an electric motor producing a total output of 380 horsepower and a maximum torque of 428 lb.-ft. at 1000 rpm. The hybrid drive offers several driving modes, ranging from an all-electric mode for emissions-free driving in

residential areas, to an “e-boost” function where the electric motor assists the combustion engine, to a coasting mode where the combustion engine is switched off.

Power transmission in the rear-wheel-drive Panamera S Hybrid is facilitated by the eight-speed Tiptronic S gearbox, which ensures rapid gear

changes combined, naturally, with high levels of gearshift and ride comfort. The 7th and 8th gears have a very long ratio, which helps to reduce fuel consumption, particularly on long highway stretches.

Impressively, the Panamera S Hybrid accelerates from 0–60 mph in 5.7 seconds, and has a top track speed* of 167 mph.

Visually, the Panamera S Hybrid is identical both inside and out to the Panamera S, the only difference being the “hybrid” logo on the front doors, rear lid, and tachometer.

Standard features include Bi-Xenon™ headlights with dynamic range adjustment, 18-inch Panamera S wheels with Tire Pressure Monitoring System (TPMS, p. 58), automatically dimming exterior and interior mirrors, and seat heating at the front. In addition, the



Interior of the Panamera S Hybrid in two-tone Black and Platinum Grey with Brushed Aluminum interior package

Panamera S Hybrid comes with adaptive air suspension, including Porsche Active Suspension Management (PASM), Servotronic (p. 57), and a rear window wiper.

Inside the vehicle, the TFT color display in the instrument cluster keeps you informed about the hybrid drive's energy flow, while further information can be accessed via the PCM.

Thanks to Porsche Intelligent Performance, the new Panamera S Hybrid delivers the performance of a sports car—and the efficiency of a hybrid.



Panamera S Hybrid with 19-inch Panamera Design wheels

*Top track speed is achieved when vehicle is equipped with optional summer tires with adequate speed rating.

Meet the pinnacle of the Panamera range.

The Panamera Turbo and the new Panamera Turbo S.

Four doors. Four seats. Eight cylinders. Up to this point, others may even have been able to keep up—until the Panamera Turbo and the new Panamera Turbo S arrived. They not only join a long line of Porsche Turbo models, but they lead the way with their extensive

standard equipment combined with a host of features that are exclusive to a Turbo.

What about the aesthetics? 19-inch Panamera Turbo wheels are standard for both Turbos, and 20-inch 911 Turbo II and 20-inch RS Spyder wheels are

no-cost options for Panamera Turbo S, with red brake calipers, naturally. The standard sport exhaust system with twin dual-tube tailpipes in the unmistakable Turbo design. Four LED daytime running lights in each Bi-Xenon™ unit, with separate direction indicators. The front apron



Panamera Turbo



Panamera Turbo S with optional Porsche Ceramic Composite Brakes (PCCB)

features horizontal slats and longitudinal struts in the air intakes. The air outlets in the fender behind the front wheels also have slats. Five, to be exact, and all in a chrome finish. The titanium-colored rear apron likewise features slats. The auto-deploying, adaptive, four-way retractable rear spoiler, finished in black on the Panamera Turbo and in the exterior color on the Panamera Turbo S, displays the sports car heritage of the Panamera.

The Panamera Turbo S also features more distinctive side skirts and is available in an exclusive standard color: Agate Grey Metallic.

Both models are powered by a 4.8-liter, twin-turbo V8 engine. On the Panamera Turbo, it generates an output of 500 horsepower and 516 lb.-ft. of torque. Thanks to faster-responding turbochargers with titanium/aluminum alloy turbine and compressor

wheels, and adapted electronic engine management, the engine on the Panamera Turbo S delivers 550 horsepower and a torque of 553 lb.-ft. (590 lb.-ft. with overboost).

The 7-speed Porsche Doppelkupplung (PDK, p. 47) is standard on both models, as is Porsche Traction Management (PTM, p. 53) with active all-wheel drive and an electronic and map-controlled multiplate clutch.

The Panamera Turbo S also comes as standard with Porsche Dynamic Chassis Control (PDCC) including Porsche Torque Vectoring Plus (PTV Plus, p. 61), the sport exhaust system, and the Sport Chrono Package Turbo (p. 65). Displays in the instrument cluster and PCM keep you informed about the car's current longitudinal and lateral acceleration.*

Standard on both models is adaptive air suspension including Porsche Active Suspension Management (PASM, p. 59). Increased performance or greater comfort? The choice is yours. At the press of a button.

The Panamera Turbo completes the sprint from 0–60 mph in just 3.8 seconds with Sport Chrono Plus and has a top

track speed** of 188 mph. The new Panamera Turbo S accelerates to 60 mph in 3.6 seconds and boasts a top track speed** of 190 mph.

The interior is a perfect combination of sportiness and comfort. As standard equipment, the interior features electrically adjustable 14-way power seats with memory package in the front

(p. 91), with seat heating front and rear. Also standard is the Smooth-Finish Leather trim. The Panamera Turbo is accented with the Walnut interior package.

The Panamera Turbo S has a choice of two exclusive two-tone interiors—Agate Grey and Cream, or Black and Cream. The interior also features the Anthracite Birch interior



Interior of the Panamera Turbo S in two-tone Agate Grey and Cream



Panamera Turbo and Panamera Turbo S

package with accents of the Porsche Crest on the front seats and the “turbo S” logo on the door-entry guards.

The Panamera Turbo models. Comfort and sports car technology side by side. What you would expect from Porsche.

Audio and communications on both models are via the Porsche Communication Management (PCM) with navigation module combined with the Bose® Surround Sound system (p. 101). The Burmester® High-End Surround Sound System (p. 103) is also available as an option.

*Available from 10/2011.
**Top track speed is achieved when vehicle is equipped with optional summer tires with adequate speed rating.



Performance

The level of performance Panamera offers isn't something that comes from merely adding power to an existing chassis. It comes from engineering conceived to deliver a true driver's car, a true sports car experience. As only a Porsche can.

**Gasoline or a hybrid. Your choice.
One result: Porsche.**

Engines.

It's always been the Porsche way to use engine power as a precision tool. Where others rely on large displacement to yield massive power, Porsche engineers focus on the physics of performance. How little can a component weigh? How fast can a part move? How exact can the air/fuel mixture be? When it comes to the

environment, the facts speak for themselves—the Panamera engines are highly efficient and low on fuel consumption, but high on power output.

This has been achieved thanks to technologies such as Direct Fuel Injection (DFI), the parallel full hybrid, VarioCam Plus or variable

camshaft control, turbocharging, and the Auto Start Stop function. Also by reducing weight, as the engines are comparatively lightweight and structurally rigid for low fuel consumption and a long service life.

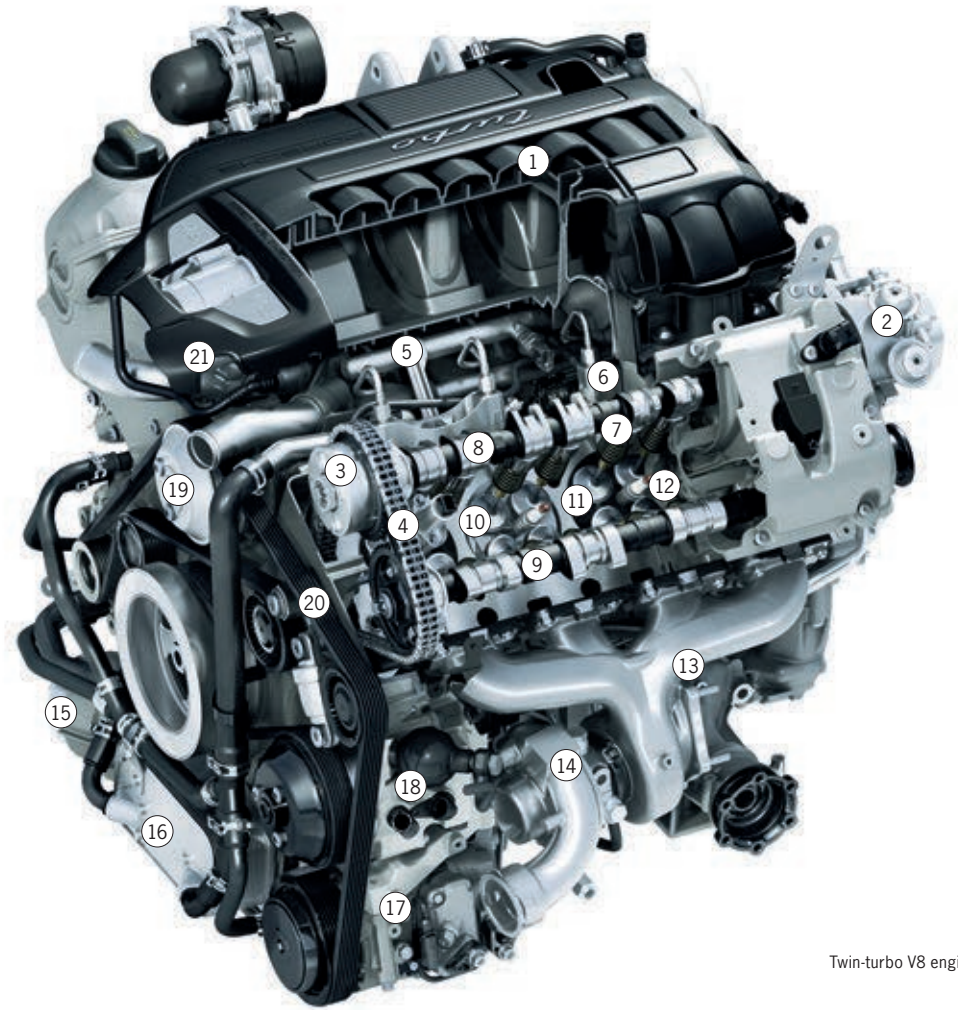

Twin-turbo V8 engine

- | | | |
|--------------------------------------------------------------------------------|------------------------------|---------------------------------|
| 1. Intake manifold | 8. Intake camshaft | 17. Air-conditioning compressor |
| 2. High-pressure pump | 9. Exhaust camshaft | 18. PDCC/power-steering pump |
| 3. VarioCam Plus (vane-cell controller) | 10. Valve | 19. Water pump (underneath) |
| 4. Duplex chain | 11. Piston (underneath) | 20. Poly v-belt |
| 5. High-pressure rail | 12. Spark plug | 21. Throttle body/E-gas |
| 6. Injector (underneath) | 13. Exhaust manifold | |
| 7. VarioCam Plus (switch tappets with integrated valve-clearance compensation) | 14. Turbocharger | |
| | 15. Oil filter | |
| | 16. Oil/water heat exchanger | |



V6 engine

V6 engine.

The Panamera and Panamera 4 models are equipped with an efficient and lightweight 3.6-liter, naturally aspirated V6 engine based on the V8 power unit. A balance shaft reduces vibration to ensure very smooth operation. Direct Fuel Injection (DFI), VarioCam Plus, and integral dry-sump lubrication are standard features. The engine delivers 300 horsepower at 6200 rpm. Maximum torque of 295 lb.-ft. is achieved at 3750 rpm.

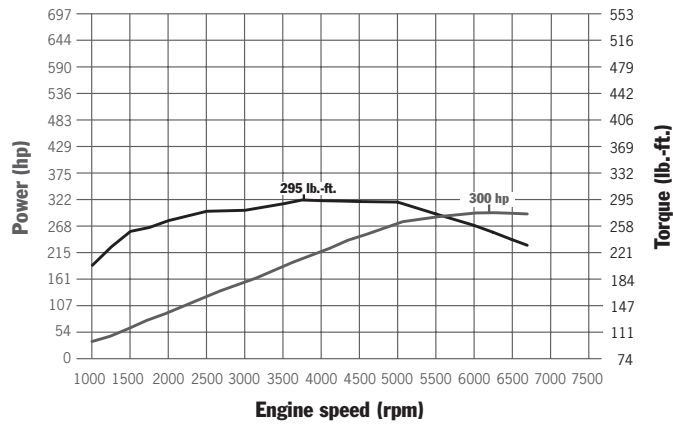

Panamera and Panamera 4: 300 horsepower at 6200 rpm, 295 lb.-ft. of torque at 3750 rpm

This impressive power output enables the rear-wheel-drive Panamera to accelerate to 60 mph in 6.0 seconds and have a top track speed* of 160 mph. Thanks to PDK and the active all-wheel drive of Porsche Traction Management (PTM), the Panamera 4 completes the sprint in 5.8 seconds and has a top track speed* of 159 mph.

*Top track speed is achieved when vehicle is equipped with optional summer tires with adequate speed rating.

V8 engine.

The Panamera S and the Panamera 4S both have a 4.8-liter, naturally aspirated V8 engine with Direct Fuel Injection (DFI), VarioCam Plus, and a variable-intake manifold. It generates 400 horsepower at 6500 rpm and has a maximum torque of 369 lb.-ft. between 3500 rpm and 5000 rpm.

The engine has been designed using lightweight technology, including cast-aluminum pistons and single-piece aluminum cylinder heads. An integral dry-sump lubrication system ensures a reliable oil supply, even when a high-performance driving style is used.

Delivering a top track speed* of 175 mph, the Panamera S accelerates to 60 mph in just 5.2 seconds, and has a top track speed* of 175 mph. Thanks to PDK and the active all-wheel drive of Porsche Traction Management (PTM), the Panamera 4S completes the sprint in an even more impressive 4.8 seconds and has a top track speed* of 175 mph.



V8 engine

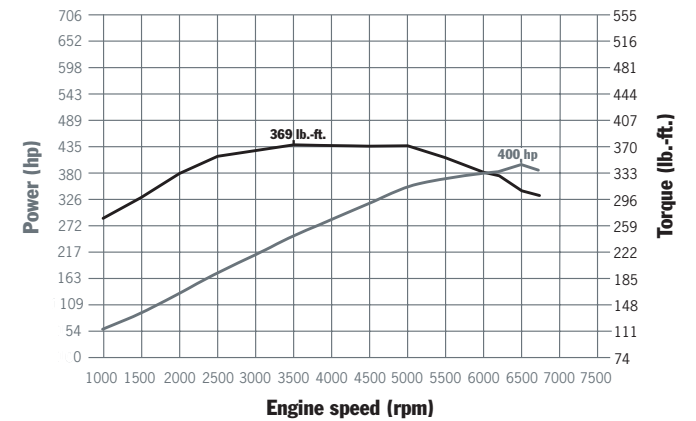

Panamera S and 4S: 400 horsepower at 6500 rpm, 369 lb.-ft. of torque between 3500 and 5000 rpm



The twin-turbo V8 engine in the Panamera Turbo

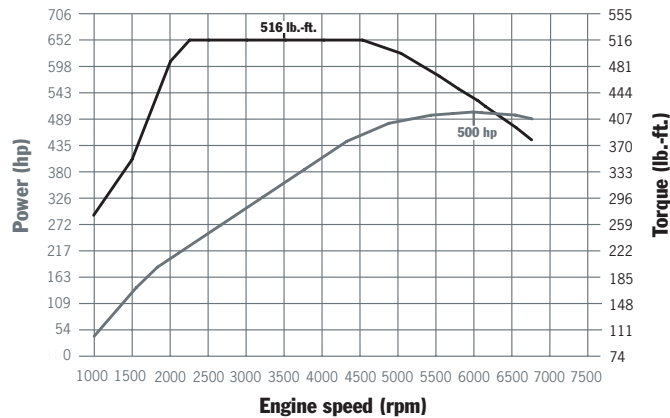

Panamera Turbo: 500 horsepower at 6000 rpm, 516 lb.-ft. of torque between 2250 and 4500 rpm

Twin-turbo V8 engines.

The 4.8-liter, twin-turbo V8 engine is available in two power ratings: the 500-hp version with a maximum torque of 516 lb.-ft., which powers the Panamera Turbo, and the 550-hp variant in the Panamera S, which features a maximum torque of 553 lb.-ft. (590 lb.-ft. with overboost).

The engines have been designed using lightweight technology, including forged pistons and one-piece aluminum cylinder heads, and feature integral dry-sump lubrication for a reliable oil supply, even when a high-performance driving style is adopted. They also have Direct Fuel Injection (DFI), VarioCam Plus, and charge-air cooling.

The higher power output for the Panamera Turbo S has been achieved by revising the engine management system and using two modified turbochargers whose lighter turbine wheels,

made from a titanium/aluminum alloy, respond up to 30 percent more quickly. Visually, that extra power is expressed by new engine-compartment styling featuring a titanium-colored intake manifold and carbon-fiber inlays.

In terms of performance figures, the top track speed* of the Panamera Turbo is 188 mph and that of the Panamera Turbo S is 190 mph. The Panamera Turbo sprints from 0–60 mph in 3.8 seconds, the Panamera Turbo S in 3.6 seconds (with activated Sport Plus button).

The Sport Chrono Package Turbo (p. 67), optional on the Panamera Turbo and standard on the Panamera Turbo S, enhances performance even more. The “overboost” function temporarily increases the charge pressure by up to 10 percent when accelerating at full throttle, enabling the Panamera Turbo and the Panamera Turbo S to briefly deliver up to 568 lb.-ft. and 590 lb.-ft. of torque respectively.



The twin-turbo V8 engine in the Panamera Turbo S

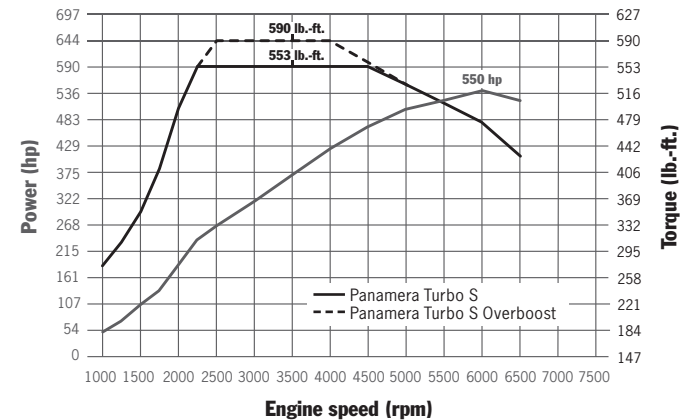

Panamera Turbo S: 550 horsepower at 6000 rpm, 553 lb.-ft. of torque (590 lb.-ft. with overboost) between 2250 and 4500 rpm

*Top track speed is achieved when vehicle is equipped with optional summer tires with adequate speed rating.

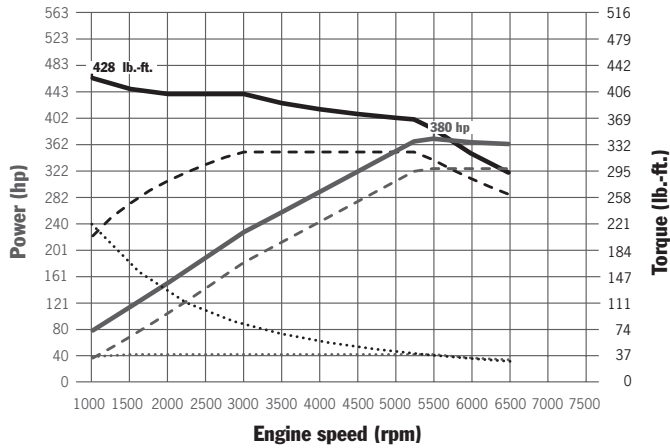

Panamera S Hybrid total system
 Panamera S Hybrid electric motor
 Panamera S Hybrid combustion engine

The parallel full hybrid.

The Panamera S Hybrid has a 3.0-liter, supercharged V6 engine with Direct Fuel Injection (DFI) and fully variable-intake camshaft timing adjustment. Combined with the charge effect of the supercharger, this ensures a high torque of 324 lb.-ft., even at low engine speeds. Power output is 333 horsepower.

The combustion engine is assisted by a 47-hp electric motor incorporated between the transmission and the engine. The motor is powered by a high-voltage nickel-metal hydride (NiMH) battery located below the floor of the rear luggage compartment.

Together, the two units develop a maximum total system output of 380 horsepower and a maximum system torque of 428 lb.-ft., and accelerate the Panamera S Hybrid from 0–60 mph in 5.7 seconds. Top track speed* is 167 mph.

The interplay between combustion engine, electric motor, and high-voltage battery is regulated by the electronic engine management system. It engages and disengages the combustion engine by means of a specially developed separating coupling. Thanks to the rapid-action separating coupling and the equally fast response of the combustion engine, these processes are performed comfortably and smoothly.

Drive modes specific to the hybrid.

The electric motor can drive the car by itself for short distances at moderate acceleration

and speeds up to 52** mph. So you can drive through residential areas, without any emissions and making almost no noise. The combustion engine is automatically decoupled via the separating clutch and switched off.

Pressing the “e-power” button expands the range in which the vehicle can run solely on electric power. Here, the accelerator pedal characteristics are adapted so that the combustion engine switches on later than in Normal mode, depending on power demand. This makes all-electric driving easier and more

comfortable. The availability of all-electric mode depends on factors such as battery charge status and temperature.

The electric motor can also assist the combustion engine to provide more thrust. This so-called e-boost function ensures sportier acceleration and improved flexibility.

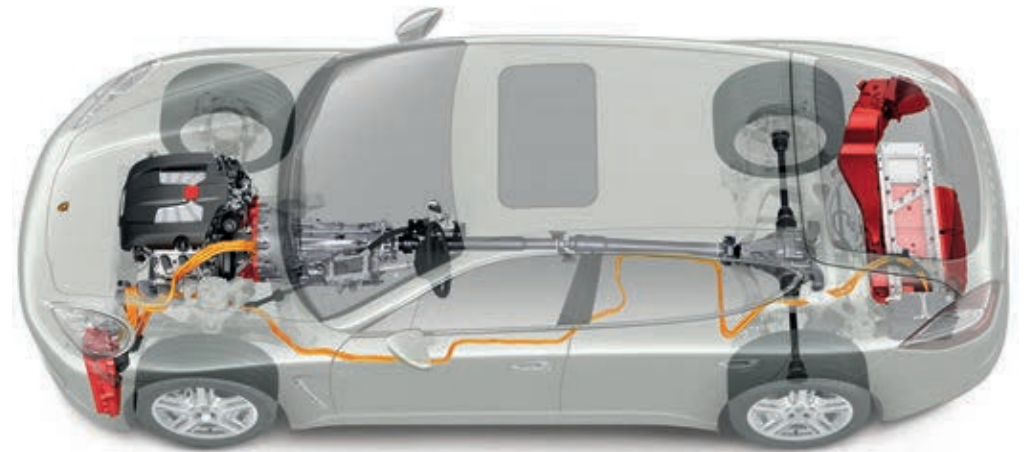

Parallel full hybrid

*Top track speed is achieved when vehicle is equipped with optional summer tires with adequate speed rating.
 **Achieved with optimal low rolling-resistance tires.



With the integral Auto Start Stop function, if you have to stop in traffic, the combustion engine is automatically switched off. It starts again only when you accelerate and the power available from the electric motor alone is not sufficient. This saves fuel.

A further energy saving can be made by coasting during

driving—it switches off automatically. You can see this from the tachometer, which will be on READY and not displaying any revs. Through this, the hybrid shows its advantages away from city traffic.

Systems which are normally dependent on the drive power of the combustion engine, such as climate control,

power steering, and braking, are powered electrically in the Panamera S Hybrid and therefore remain available even when the car is being driven solely using electric power or when it is coasting with the combustion engine switched off.

Recuperation (braking energy recovery).

Braking processes are controlled so that, on activation of the brake pedal, energy can be recovered—or recuperated—via the generator mode of the electric motor. The battery is charged with braking energy, so to speak. The conventional braking system provides the additional required braking power.

Display concept.

The e-power meter in the instrument cluster shows the recuperation power and the drive power of the electric motor, and the TFT color display gives real-time information on the energy flow. Porsche Communication Management (PCM) shows a detailed diagram of the vehicle with energy flow and statistics on the amount of driving without the combustion engine.



Hybrid display in the instrument cluster



Energy flow display in Porsche Communication Management (PCM)

Sport button.

All Panamera models are equipped with the Sport button as standard. It can be used to change the engine characteristics, the chassis setup (on vehicles with PASM), and the transmission control system.

Auto Start Stop function.

This feature is designed for increased fuel efficiency. If you stop at traffic lights with your foot on the brake pedal, the Auto Start Stop function will automatically stop the engine. This system restarts the engine as soon as you release the brakes.

A key advantage is that there is no need for you to change your driving habits. You can simply carry on as normal. All audio and communication systems remain switched on and the climate

control continues to maintain your selected temperature, despite the engine's being switched off. The engine restarts if more power or extra cooling output is required.

On all models except the Panamera S Hybrid, the Auto Start Stop function can be activated and deactivated using a separate button. The function may remain inactive under particular circumstances such as very high outside temperatures, on extreme uphill gradients, or if battery charge is low.

Direct Fuel Injection (DFI).

With millisecond precision, DFI injects fuel at up to 1,740 psi directly into the combustion chamber by means of electromagnetically actuated injection valves.

The spray and cone angles have been optimized for torque, power output, fuel consumption, and emissions by enabling a homogeneous distribution of the air/fuel mixture and, therefore, effective combustion. DFI

improves the internal cooling of the combustion engine by having the mixture prepared directly in the cylinder. This allows for a higher compression ratio, which helps to deliver more output at the same time as enhanced engine efficiency.





VarioCam Plus

VarioCam Plus.

VarioCam Plus is a two-in-one engine concept for adjusting the intake camshafts and switching the lift of the intake valves.

The system first differentiates between driver inputs that typify normal, everyday driving and those inputs that demand maximum power. The electronic

engine management system then seamlessly adapts valve operation to the prevailing conditions. This results in instant acceleration and extremely smooth running.

At medium revs and minimal load, low valve lifts with advanced timing reduce fuel consumption and exhaust emissions and improve smooth running. The

increase in fuel economy is particularly pronounced in the lower engine-speed range. High torque and maximum output are achieved through high valve lifts and advanced timing.

How does this benefit you? Extraordinary power with relatively low fuel consumption. VarioCam Plus is standard on the Panamera, Panamera 4, Panamera S, and Panamera 4S, and on the Panamera Turbo models.

Variable camshaft control.

In the V6 combustion engine of the new Panamera S Hybrid, fully variable camshaft control is used to adjust the intake camshaft timing. This is effectively controlled by the electronic engine management system. The result is high specific output and high torque—even at low engine speeds—and above all, reduced fuel consumption and emissions.

Lightweight exhaust system.

The exhaust system is made from selected long-life stainless steel. The powerful primary and main catalytic converters heat up rapidly for effective emissions control.

The exhaust system of the Panamera Turbo models switches between two configurations automatically: low noise at lower revs and engine loads, and increased throughput at high revs under maximum engine load.

Sport exhaust system.

Standard on the Panamera Turbo S is a sport exhaust system with two twin tailpipes in a special Turbo design. Available as an option for the Panamera, Panamera 4, Panamera S, Panamera 4S, and Panamera Turbo is a sport exhaust system featuring distinctive tailpipe covers. Activated by a separate button, the sport exhaust system produces an even more authentic sports car sound.



Panamera 4S with sport exhaust system

Double your pleasure.

Transmission.

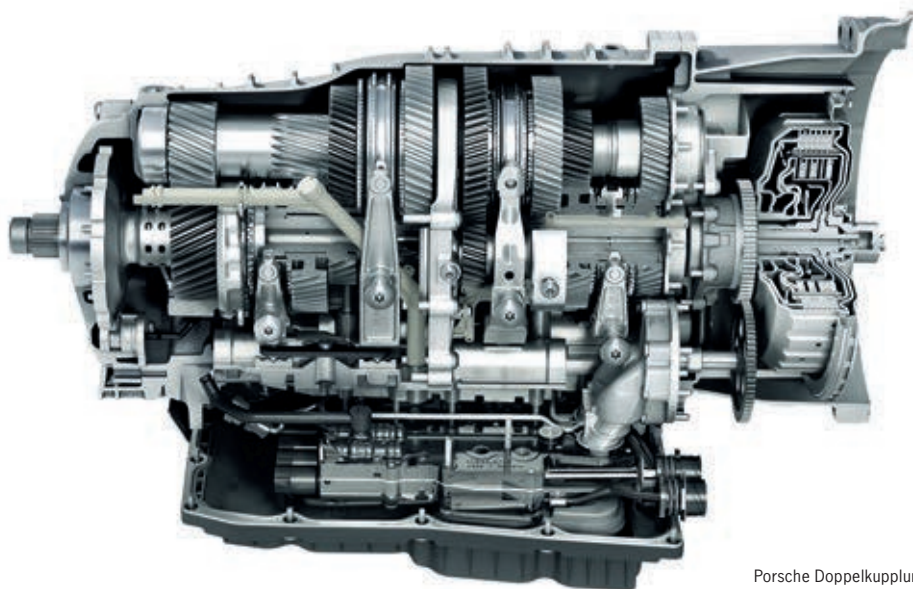

Porsche Doppelkupplung (PDK)

Porsche Doppelkupplung (PDK).

The 7-speed PDK has both a manual gearshift and an automatic mode and enables smooth gear changes with no interruption in the flow of power. Gears 1 to 6 have a sport ratio, and top speed is reached in 6th gear. The 7th gear has a

long ratio, which reduces fuel consumption even further and keeps engine revs comfortably low even at high road speeds.

PDK is essentially two gearboxes in one and this requires two clutches. This double clutch provides an alternating, non-positive connection between

the two half gearboxes and the engine by means of two separate input shafts (input shaft 1 is nested inside the hollowed-out input shaft 2).

The flow of power from the engine is transmitted through one half gearbox and one clutch at a time, while the next gear

is preselected in the other half gearbox. During a gear change, therefore, a complete shift no longer takes place. Instead, one clutch simply opens and the other closes at the same time. Gear changes can take place within a few hundredths of a second.

PDK has distinct benefits, including a high level of driving comfort and very rapid gearshifts for faster acceleration. Driving feels even sportier and more dynamic, and agility is increased. Depending on the gearshift program (Sport button activated or deactivated), the gear change is optimized for comfort or for sporty driving. Its high level of efficiency, combined with the long-ratioed 7th gear, helps to achieve reduced fuel consumption and emissions figures.

In conjunction with the optional Sport Chrono Package Plus (p. 65) or the Sport Chrono Package Turbo (p. 67), PDK is enhanced by a “Launch Control” function, which offers a sportier acceleration and gearshift strategy in automatic

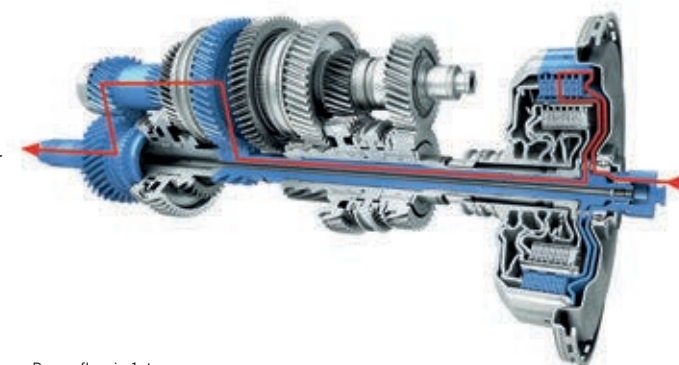

Power flow in 1st gear

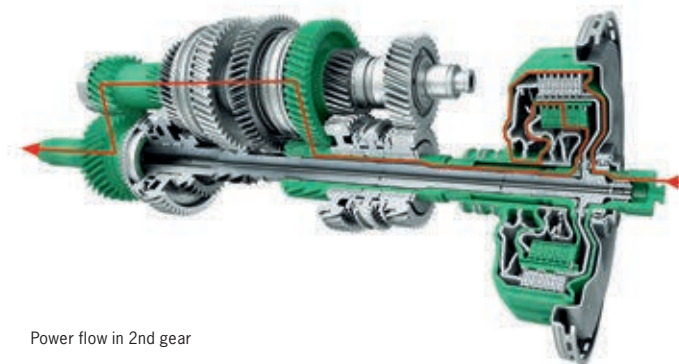

Power flow in 2nd gear

mode and extremely smooth gear changes in manual mode.

PDK offers performance with efficiency and comfort.

Eight-speed Tiptronic S gearbox.

Standard on the Panamera S Hybrid is the eight-speed Tiptronic S gearbox with a wide range of gears. This results in fuel savings and a reduction in highway noise level.

You can also influence the shift behavior of the eight-speed Tiptronic S by deliberate use of the accelerator and brake pedals. Dynamic driving leads to more dynamic gear changes, and a restrained, careful driving style leads to economic shifts. You can, of course, also change

gears manually using either the two ergonomic sliding switches on the sport steering wheel or the gear selector. Push forward and the Tiptronic S shifts up. Pull back and it shifts down.



SportDesign steering wheel with Tiptronic S paddles



Eight-speed Tiptronic S gearbox



Panamera S Hybrid



PDK gear selector

Multifunction steering wheel.

The standard multifunction steering wheel has two ergonomic sliding switches for changing gear. One press forward with the thumb and the transmission shifts up. One pull backward with the index finger and it shifts down. Either the right or left hand can be used.

Even if the gear selector is set to automatic, you can still use the switches to change gear manually at any time. In this

way, even in automatic mode, you can achieve a short burst of speed for an overtaking maneuver. The system reverts to automatic mode if no manual inputs are detected for approximately eight seconds.

Using the gear selector, you can also change gear manually in a separate one-touch manual shift gate. Press forward to shift up; pull backward to shift down.

The multifunction steering wheel incorporates conveniently placed buttons for the control of various vehicle functions and settings. The multifunction steering wheel also features steering-wheel heating.

When PDK is combined with the Sport Chrono Package, there is an additional display above the airbag module. It tells you whether the Sport, Sport Plus, and Launch Control functions are activated.

SportDesign steering wheel.

The SportDesign steering wheel with gearshift paddles is available on request. The alloy paddles are ergonomically located behind the right and left steering-wheel spokes. Pull the right-hand paddle to shift up. Pull the left-hand paddle to shift down.

Visually, the steering wheel is distinguished by its distinctive high-quality twin-spoke design and silver-colored spoke cover.

This steering wheel also has an additional display when combined with PDK and a Sport Chrono Package. Located in the left- and right-hand steering-wheel spokes, it tells you whether Sport, Sport Plus, and Launch Control are activated.

Another feature, reminiscent of the world of motorsport, is the top center marking on the steering-wheel rim.



Multifunction steering wheel, Sport Chrono Package Turbo



SportDesign steering wheel, Sport Chrono Package Turbo

You always like to have your feet firmly planted on the ground. With all-wheel drive, you can.

Porsche Traction Management (PTM).

Fitted as standard on the Panamera 4, Panamera 4S, and the Panamera Turbo models, Porsche Traction Management (PTM) comprises an active all-wheel drive with electronic and map-controlled multiplate clutch with Automatic Brake Differential (ABD) and Anti-Slip Regulation (ASR).

The electronically controlled multiplate clutch regulates the distribution of drive force between the permanently driven rear axle and the front axle.

Through continuous monitoring of the driving conditions, the electronics are able to respond to a variety of situations.

Sensors check, among other variables, the rotation speeds of all four wheels, the longitudinal and lateral acceleration of the vehicle, and the steering angle.

If the rear wheels threaten to spin under acceleration, a greater proportion of drive force is distributed to the front by a



All-wheel drive

more powerful engagement of the multiplate clutch. In addition, ASR helps to reduce wheel slip. When cornering, the front wheels only ever receive as much drive force as is necessary to maintain optimal lateral stability.

In this way, PTM, in conjunction with the enhanced Porsche

Stability Management (PSM, p. 63), ensures that the perfect distribution of drive is achieved every time: whether on long straights, through tight corners, or on surfaces with different friction coefficients. In this situation, traction is additionally enhanced by the Automatic Brake Differential (ABD).

Whenever the brake control systems are required to intervene, PTM decouples the front axle completely so that PSM interventions can take place at each individual wheel.

**Sorry. The condition of the roads is beyond our control.
We'll just make the car adapt instead.**

Chassis.

Through the purposeful use of lightweight technologies, we have managed to save weight in the chassis and increase efficiency. The next challenge was the question of how to reconcile the characteristics of a sports car with the requirements for comfort demanded of a sedan. The answer: modern axle technology. High performance and driving safety, through precise traction control systems, and powerful tires and brakes.

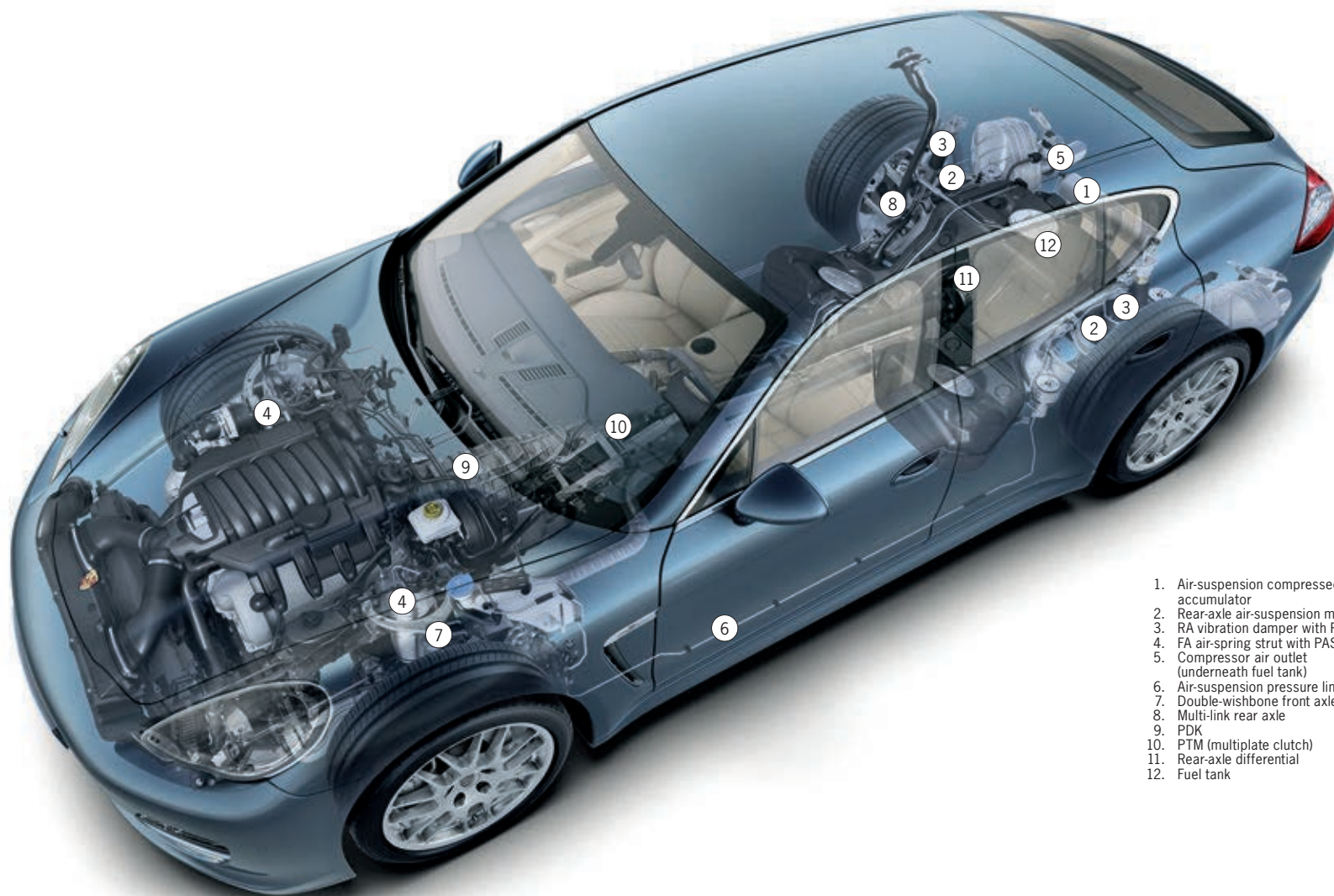

1. Air-suspension compressed-air accumulator
2. Rear-axle air-suspension modules
3. RA vibration damper with PASM
4. FA air-spring strut with PASM
5. Compressor air outlet (underneath fuel tank)
6. Air-suspension pressure line
7. Double-wishbone front axle
8. Multi-link rear axle
9. PDK
10. PTM (multiplate clutch)
11. Rear-axle differential
12. Fuel tank



Panamera Turbo front axle



Panamera Turbo rear axle

Suspension.

The front axle has a wide-spaced aluminum double-wishbone arrangement with an aluminum subframe. The wide spacing between the wishbones keeps the forces in the wheel suspension low for precision wheel guidance and excellent handling. The rear axle is an aluminum multi-link setup. This axle design minimizes the pitching of the body under acceleration and braking.

The high proportion of aluminum used in the construction of the axles reduces the weight of the

vehicle and of the unsprung masses, helping to improve fuel economy and increase agility.

Steering and Servotronic.

“Precise” and “direct” describe a Porsche steering system with variable-steering ratio. Around the straight-ahead position, such as during highway driving, the ratio is less direct with no loss of agility or feedback from the road. When the steering wheel is turned further, the ratio becomes more direct, allowing easier cornering and parking.

Standard on the Panamera S Hybrid and Panamera Turbo S and optional for all other Panamera models is Servotronic, a speed-sensitive power-steering system. At high speeds, the steering is firm and responds with extreme precision while steering comfort remains as high as you would expect. At low speeds, Servotronic’s ratio adjusts for easy maneuvering and parking.

Wheels and Tire Pressure Monitoring System (TPMS).

The Panamera and Panamera 4 have the standard 18-inch Panamera wheels. The Panamera S, 4S, and Panamera S Hybrid feature the 18-inch Panamera S wheels. All wheels are lightweight alloys featuring a classic sporty design. Tire sizes 245/50 ZR 18 and 275/45 ZR 18 are fitted to the front and rear, respectively.

The Panamera Turbo is equipped with 19-inch Panamera Turbo alloy wheels as standard. The tire sizes are 255/45 ZR 19 at the front, 285/40 ZR 19 at the rear.

The new Panamera Turbo S has available as a no-cost option the 20-inch 911 Turbo II wheels fitted with 255/40 ZR 20 tires at the front and 295/35 ZR 20 tires at the rear.

A selection of other 19-inch and 20-inch wheels is available from our range of options.

All-season tires are standard for all models with standard or optional 19-inch wheels. A

low rolling-resistance version of these tires is available as an option. On this tire, the rubber compound, the tread pattern, and the architecture of the tire substructure have been optimized to minimize rolling resistance and thus improve fuel economy, while maintaining comfort and performance.

The standard Tire Pressure Monitoring System (TPMS) sends warnings to the onboard computer’s display screen in the event of low tire pressure.



19-inch Panamera Turbo wheel



18-inch Panamera S wheel



20-inch 911 Turbo II wheel



19-inch Panamera Turbo wheel

The road to success is rarely a smooth one.

Porsche Active Suspension Management (PASM).

Optional for the Panamera and Panamera 4 and standard on all other models, PASM is an electronic damping-control system that offers continuous adjustment of the damping

forces for each individual wheel according to road conditions and driving style. This reduces body movement and thus increases comfort in each of the four seats.

Using a separate button on the center console, the driver can select between three modes: "Comfort," "Sport," or "Sport Plus." Sensors record the body movements that accompany

powerful acceleration, braking, and rapid cornering or uneven road surfaces. The PASM control unit evaluates the driving conditions and modifies the damping force on each of the wheels in accordance with the selected mode. You can feel the result: increased driving stability, more comfort, and improved performance.

Adaptive air suspension.

The Panamera S Hybrid and the Panamera Turbo models are equipped with adaptive air suspension and PASM as standard. This combined system enhances both driving dynamics and comfort at the same time. For all other Panamera models, adaptive air suspension is available as an option.

It comprises a leveling system, a manual lift function, ride-height adjustment capability, and the ability to vary the spring rate.

The purpose of the leveling system is to automatically keep the vehicle level constant, regardless of load distribution. For maneuvering, the manual lift function enables you to raise the vehicle body by 0.78 of an inch to minimize the risk of grounding. When you select the Sport Plus chassis program, the height of the body automatically drops to Low Level (-0.98 of an inch). At the same time, a harder spring rating is achieved through a reduction in the amount of air stored in the air suspension. In simple terms, it's a sport chassis at the push of a button.



A wavering course was never your thing.

Porsche Dynamic Chassis Control (PDCC) with Porsche Torque Vectoring Plus (PTV Plus).

A Porsche holds the road well, its handling sporty and precise—but you’ve known this for a long time.

What you might not know is that Porsche Dynamic Chassis Control (PDCC) with Porsche Torque Vectoring Plus (PTV Plus)—standard on the Panamera Turbo S and optional for all other models except the

Panamera S Hybrid—improves roadholding even further for even more dynamic performance and increased comfort.

PDCC is an active anti-roll system that anticipates and significantly reduces lateral body movement during cornering maneuvers. In addition, it helps minimize the lateral instability of the vehicle

on uneven ground. The effect is achieved with the aid of active anti-roll bars on the front and rear axles, which respond to the current steering angle and lateral acceleration by producing a stabilizing force that precisely negates the roll of the body. PTV Plus combined with PDCC is a system that actively enhances vehicle dynamics and stability.

Operating in conjunction with an electronically regulated rear differential lock, it works by varying the torque distribution to the rear wheels. As a function of steering angle and steering speed, accelerator pedal position, yaw rate, and vehicle speed, PTV Plus is able to improve steering response and steering precision by specific braking of the right or left rear wheel.

To be more precise, this means that, when the car is driven assertively into a corner,

moderate brake pressure is applied to the inside rear wheel. Consequently, a greater amount of drive force is distributed to the outside rear wheel, inducing an additional rotational pulse (yaw movement) around the vehicle’s vertical axis. This results in a direct and sporty steering action as the car enters the corner.

At low and medium vehicle speeds, PTV Plus significantly increases agility and steering precision. At high speeds and when accelerating out of corners, the electronically regulated rear

differential lock helps to ensure greater driving stability. It also serves to improve traction at the rear wheels on road surfaces with varying levels of grip, as well as on snow and ice.

For the driver, this means remarkable stability and easier handling, optimal traction, and greater agility at speed with precise steering and stable load transfer characteristics. The result is a high level of driving pleasure.



Rapid cornering in the Panamera S without PDCC (illustrative example)



Rapid cornering in the Panamera Turbo with PDCC (illustrative example)

Even a Porsche has limits to its dynamic performance.

Porsche Stability Management (PSM).

As standard, all Panamera models are equipped with enhanced Porsche Stability Management (PSM), which helps maintain stability during dynamic driving. Sensors continuously monitor the direction, speed, yaw velocity, and lateral acceleration of the car. Using this information, PSM is able to calculate the actual direction

of travel at any given moment. If the car begins to oversteer or understeer, PSM applies selective braking on individual wheels to help restore stability.

Under acceleration on wet or low-grip road surfaces, PSM improves traction—and agility—using the Automatic Brake Differential (ABD), Anti-

Slip Regulation (ASR), and Engine Drag Torque Control (MSR).

When Sport Plus mode is selected on the optional Sport Chrono Package Plus (p. 65) or Sport Chrono Package Turbo (p. 67), the PSM intervention threshold is raised to allow a sportier driving style.

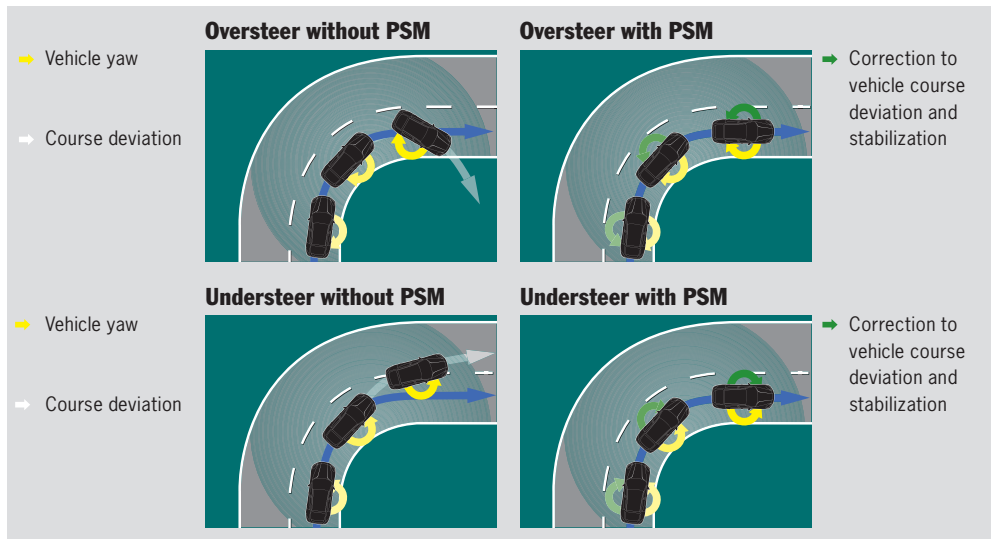

For a more dynamic experience, you always have the option to deactivate PSM. It is automatically reactivated, for your safety, only if you brake harder and either of the front wheels (in Sport Plus mode, both of the front wheels) requires ABS (Anti-

lock Brake System) assistance. ABS and ABD, however, remain active at all times.

PSM includes two additional functions: precharging of the brake system—enabling full braking power to be achieved

much sooner—and Brake Assist for maximum deceleration in emergency braking situations.

PSM therefore offers a high level of driving stability and safety combined with extraordinary agility.

**Your mind is somewhere else.
How are you going to get there?**

Performance enhancement systems.



Sport buttons in the center console

higher engine speeds than in Comfort mode, and downshifts are swifter. When equipped with Porsche Active Suspension Management (PASM) and Porsche Dynamic Chassis Control (PDCC), the switch to Sport mode delivers harder damping and more direct steering and, therefore, more agile cornering.

Sport Chrono Package Plus.

Providing the Panamera models with a sportier setup is the optional Sport Chrono Package Plus. For the Panamera Turbo, there is the optional Sport Chrono Package Turbo (standard on the Panamera Turbo S).

Included in the package are a digital and analog stopwatch, the Sport Plus button, and a performance display in the PCM for displaying lap times.

Sport button.

The Sport button, which is fitted as standard on all models, enables you to select a setup that favors either comfort or sporty performance. At the push of a button, the electronic engine management system switches the engine mapping to offer a sharper response and engine dynamics that are more direct. The system upshifts in automatic mode take place at

When the Sport Plus button on the center console is selected, the engine management system adapts the engine for a sharper response. The rev limiter is adjusted to a harder setting.

Vehicles with Porsche Active Suspension Management (PASM) switch to Sport Plus mode for harder damping and more direct steering. Panamera models with adaptive air suspension lower the chassis to Low Level and switch to a stiffer spring rate.

In Sport Plus mode, the trigger threshold for PSM is raised for increased longitudinal and lateral dynamics. Agility is enhanced when braking for corners, with PSM enabling greater maneuverability under braking and exit acceleration, especially at low speeds.

For maximum dexterity, PSM can be set to standby while the car is still in Sport Plus

mode. For safety, it is set to intervene automatically only when ABS assistance is required on both of the front wheels.

The stopwatch mounted on the dashboard displays recorded driving time in hours, minutes, and seconds. Seconds, tenths, and hundredths of a second appear on a display screen. Alternatively, the stopwatch can be used as a conventional clock. Porsche Communication Management (PCM, p. 96) has a special performance display to view, store, and evaluate lap times or other driving times. It shows the total driving time, lap distance, lap number, and lap times recorded so far. You can evaluate your daily mileage or define benchmark times and rediscover your old routes.

The shift times in Sport Plus mode are shorter, the gear changes sportier. In automatic mode and at low rates of deceleration—even with high engine speeds—the system initiates a swifter brake-induced downshift. In manual mode, gear changes are faster, more dynamic, and more direct.



Digital and analog stopwatch on the dashboard

Launch Control, also a feature of Sport Chrono Package Plus, is designed to produce optimal acceleration from a standing start. This function is operated via the Sport Plus button with the “D” or “M” drive position selected. With the left foot depressing the brake pedal, the driver fully depresses the accelerator for maximum throttle. The engine is revved to an optimal speed of around 5500 rpm and the clutch is held in slight contact.

The message “Launch Control” appears in the PDK display of the sport steering wheel, the multifunction steering wheel, or the optional SportDesign steering wheel. Now, the driver simply releases the brake pedal and prepares for maximum acceleration.



Sport Chrono Package Turbo.

For the Panamera Turbo models, increased power output is a matter of principle. The same applies to the Sport Chrono Package Turbo, which is available as an option for the Panamera Turbo (it is fitted as standard on

the Panamera Turbo S). It not only combines all the functions of Sport Chrono Package Plus—it adds one more: overboost.

Imagine you are accelerating at full throttle with the Sport or Sport Plus button selected. Boost pressure is temporarily

increased by 10 percent, which considerably increases the maximum torque that the engine is able to produce. So, for a limited period, overboost generates a torque of up to 568 lb.-ft. on the Panamera Turbo (instead of the normal 516 lb.-ft.), and a torque of up to 590 lb.-ft.

on the Panamera Turbo S (instead of the normal 553 lb.-ft.). Though the boost may be brief, the smile on your face will last a lot longer.

Illuminating: Bringing light even to the darkest of roads.

Lights.

All models are equipped with a driving light assistant, which switches the lights on automatically when it gets dark. As standard, all Panamera models are equipped with

Bi-Xenon™ headlights with low or high beam, the road ahead is illuminated more uniformly. The lighting system features an automatic switch-off and the “Welcome Home” function—

a customizable delayed switch-off timer that keeps the daytime running lights, the taillights, and, where applicable, the courtesy lights (p. 74) switched on until you reach your front door.

LED daytime running lights are standard equipment on all Panamera models. On the Panamera Turbo models, each main headlight unit has four LED spotlights; on all other models, the LEDs are arranged horizontally in the front light units. Daytime running lights improve safety during daylight hours, as they make you more visible to other road users.

Also contained in the front light units are the direction indicators, bar-shaped LED light guides in the form of position lights, or—exclusively reserved for the Panamera Turbo models—LED light guides as a border for the indicators.



Panamera S, Panamera 4S, and Panamera S Hybrid night-light design



Panamera Turbo and Panamera Turbo S night-light design



Night-light design for the Panamera models



Cornering lights of the Porsche Dynamic Light System (PDLS)

The Porsche Dynamic Light System (PDLS) is standard on the Panamera V8 and Turbo models and available as an option for all other Panamera models. Its dynamic cornering light function swivels the headlights toward the inside of a bend, based on steering angle and road speed, and the static cornering lights activate the auxiliary headlights in order to illuminate more of the road at tight curves and turns. Put simply, when you enter a curve, the road ahead is illuminated immediately so you can see any obstacles much sooner.

The system also features speed-dependent headlight range control. With adaptive light systems, it is possible for the maximum range of the

low beams to be increased as a function of the speed of the vehicle. PDLS takes care of this automatically. When driving at higher speeds, such as on the highway, the range of the low beams is adjusted by adapting the shape of the light cone, extending it further forward to improve visibility without dazzling oncoming traffic.

Another feature of the PDLS, the adverse weather function, is activated when you switch on the rear fog light. It reduces the effect of reflection phenomena in poor visibility conditions. The system fans out the low beams, and the light cone is further lowered.

Vehicles with the driver memory package or 14-way power seats

with memory package (standard in the Panamera Turbo models) feature LED courtesy lights in the exterior mirrors to illuminate the area around the doors.

LED technology is also used for the taillights, the additional brake light in the rear lid, the rear direction indicators, and the rear fog light. LEDs provide better illumination and respond more quickly to driver input. For greater safety—and an unmistakable Porsche design, day or night.



Balance

Performance, safety, and the environment are a balance—one that Porsche engineering tackled to create a level of environmental responsibility and regard for driving safety that reflects a more balanced view of one's place in the world.

On any long journey, there will come a time when you have to stop.

Brakes.

The Panamera models have a braking system equipped with six-piston, aluminum monobloc fixed brake calipers at the front and four-piston, aluminum monobloc fixed calipers at the rear. The brake calipers on the Panamera and Panamera 4 are finished in black; on the Panamera S models, they are silver-colored and on the Panamera Turbo models they are red.

The brake discs are grooved and internally vented for optimal braking performance—even under extreme conditions—and rapid heat dispersal. The brake discs on the Panamera Turbo models have a diameter of 15.4 inches at the front and 13.8 inches at the rear, while on all other models, the discs are 14.2 inches in diameter at the front and 13.0 inches at the rear.

The Anti-lock Brake System (ABS) ensures uniform deceleration. A brake pad wear indicator informs you when the brake pads need to be replaced.

The electric parking brake, which you can activate and deactivate manually, releases automatically as you pull away. With the hill-hold function, you can pull away without ever rolling back.

Porsche Ceramic Composite Brakes (PCCB).

On request, your Panamera can be fitted with a braking system that has already had to cope with the harshest requirements of the racetrack: the Porsche Ceramic Composite Brakes (PCCB). For the Panamera Turbo models, they are compatible

only with 20-inch wheels, and for all other Panamera models, they are only available in conjunction with 19-inch wheels or larger.

On the Panamera Turbo models, the cross-drilled ceramic brake discs have a diameter of 16.14 inches at the front and 13.78 inches at the rear; all other models feature discs with a diameter of 15.35 inches at the front and 13.78 inches at the rear.

PCCBs are characterized by their low thermal expansion, which prevents deformation under heavy braking. Furthermore, the ceramic brake discs are resistant to corrosion and offer more favorable noise-damping properties.

The pedal response is fast and precise with only moderate input required. All the necessary

ingredients are there for a short braking distance, even in the toughest conditions. Moreover, safety under braking at high speeds is increased, thanks to the excellent fade resistance of PCCB.

The key advantage of PCCB is the extremely low weight of the ceramic brake discs, which are approximately 50 percent lighter than standard discs of similar design and size. As well as enhancing performance and fuel economy, this has

helped to reduce unsprung and rotating masses significantly. The consequence of this is better roadholding and increased comfort, particularly on uneven roads, as well as greater agility and improved handling.



Porsche Ceramic Composite Brakes (PCCB)

It sometimes pays to be a tough nut to crack.

Body engineering.

The lightweight construction, made from super high-strength steels, stainless steel, magnesium, and aluminum, ensures a low overall weight and produces a highly resilient passenger cell that offers high levels of protection in the event of an impact. A system of longitudinal and transverse members at the front absorbs

deformation energy and disperses the forces, which minimizes deformation of the passenger cell. Passive safety is further enhanced by the aluminum subframe on the front axle, which is designed to deform in a defined manner. A rigid bulkhead crossmember reduces deformation of the footwell in the event of an impact and

provides improved protection for the feet and legs. In a minor collision, a system of easily replaceable impact absorbers prevents costly damage to the underlying bodyshell.

- Magnesium
- Aluminum
- Deep-drawn steels
- Super high-strength micro-alloyed steels
- Polyphase steels
- Boron-alloyed steels



A high level of protection will ensure that composure is maintained.

Airbags and seat-belt system.

All Panamera models are fitted as standard with full-size driver and front-passenger airbags, which are inflated in two stages depending on the severity and type of accident. In less serious accidents, the airbags are only partially inflated, thereby minimizing discomfort to the occupants.

The standard knee airbags for the driver and front passenger are supplemented by the Porsche Side Impact Protection (POSIP) system. This is comprised of side airbags in the front seats, curtain airbags along the entire roof frame and the side windows from the A-pillar to the C-pillar, and side impact protection elements in the doors. Side airbags in the rear compartment are standard.



Also featured as standard are an energy-absorbing steering column, three-point seat belts on all seats, belt height adjustment and seat-belt force limiters in the front, and seat-belt pretensioners front and rear.

A rollover sensor automatically activates the curtain airbags and seat-belt pretensioners if the vehicle threatens to overturn.

Preserving resources and protecting the planet.

Porsche and the environment.

Environmental protection.

In an era of intensifying debate about global climate change, every automotive

manufacturer is asking itself what it has to offer in terms of environmental protection. Our answer has long been the same: maximum efficiency.

Porsche is among those manufacturers achieving the lowest CO₂ emissions. This has been achieved through the new efficient engine technologies

(DFI and VarioCam Plus), lightweight construction, the Auto Start Stop function, optimized aerodynamics, and low rolling resistance.

This high level of environmental responsibility is clearly demonstrated by our approach to environmental management

at the Porsche development center in Weissach. Here, all technological developments are carried out with environmental protection in mind. The goal is pure performance—but not at the expense of the environment. A goal also achieved by the new Panamera models.

Exhaust emissions.

The Panamera models are equipped with advanced emissions-control technology.

The figures are exemplary: Vehicles manufactured by Porsche demonstrate that even high-performance sports cars can achieve comparatively moderate exhaust emissions values in their respective category. This has been achieved in part by state-of-the-art engine concepts, including the hybrid drive and gasoline

engines. In addition, a fast-heating catalytic converter system ensures that the optimal operating temperature is reached quickly after the vehicle is started, thereby further improving emissions-control system performance.

The gasoline and hybrid models feature stereo Lambda control. Each of the two cylinder banks has a separate Lambda Sensor[®] control loop. This determines, via the engine management system, the optimal quantity of fuel, thus ensuring efficient emissions control. On the V8 engines, this is assisted by an air-injection system, where a compressor pumps extra air into the exhaust tract during the catalytic converter warm-up phase for faster heating and, consequently, lower emissions.



Other measures for improving fuel economy are the Auto Start Stop function and electrical system recuperation, where the vehicle battery is charged predominantly under braking. Under acceleration, on the other hand, the charging current of the regulated alternator is reduced so that the engine does not need to work as hard to charge the battery.

Lightweight construction and recycling.

A fundamental objective in the development of any Porsche is intelligent lightweight construction. For both economical and ecological reasons. This forms the basis for low fuel consumption values in conjunction with outstanding performance. It is economical, thanks to the high proportion of aluminum cast alloys, plastics, and super high-strength sheet steel used. This is substantially more stable and lighter than conventional steel. The Panamera models have a bodyshell with a lightweight-metal content of around 23 percent. For example, the hood, doors, front fenders, and rear lid are made of aluminum, which saves on weight and has a positive effect on the environmental balance: According to eco-balance sheets, the extra energy used and the higher emissions incurred in the manufacturing of aluminum are more than compensated by the savings on fuel after only a relatively short distance.

It is also responsible because all materials used are meticulously selected. We use only innovative and environmentally friendly components. All lightweight materials are easily recyclable, and each material is labeled to facilitate its separation for recycling. The reduction in the number of plastic variants helps to ensure more efficient recycling. Recycled plastics are used where they meet our exacting technical requirements. The Panamera is approximately 95-percent recyclable.

In addition, Porsche uses only environmentally friendly water-based paints, thus reducing the need for solvents, both in production and in the workshop. The Panamera is, of course, absolutely free of asbestos, CFCs, and components manufactured using CFCs because, here at Porsche, environmental protection does not begin at the end of a vehicle's life. It starts at the planning and development stage.





Servicing.

Long service intervals are not only more convenient—they also reduce ownership costs. They promote a more sparing use of consumables and replacement parts, which for you, lowers costs and saves time. Perhaps the greatest benefit, however, is for the environment.

Additionally, Porsche Cars North America offers Service and Maintenance packages. Please see your Authorized Porsche dealer for more information.

As standard, Porsche provides a limited 4-year/50,000-mile warranty, which includes a limited 12-year anti-corrosion plan and Porsche Roadside Assistance.

Fuel.

All Panamera models with gasoline engines are designed to operate on fuels with an ethanol content of up to 10 percent.

The release of hydrocarbons from the fuel system has been minimized, thanks in no small part to the active carbon filter and the multilayered material from which the fuel tank is made. All fuel lines are made from multilayered plastic, steel, or aluminum.

Noise.

The Panamera complies with all applicable noise regulations without any form of engine encapsulation. To achieve this, noises are eliminated at the source. Engine parts are stiff,

moving parts are lightweight, and tolerances are kept to a minimum. No nuisance noise will be heard for the entire life of the vehicle.



Personalization

Is the traditional look of an old-fashioned sedan not the look for you? Would you prefer something less conventional? Then let us break the mold with sporty dynamics, authenticity, and personality.

When Porsche interprets luxury, the result is anything but ordinary.

Comfort.

The interior.

In terms of Porsche design, the Panamera models are, admittedly, a little different from what we are used to. It's no wonder, as they are the first Porsche vehicles to have four individual seats (p. 91). But that's not all.

One's first impression upon climbing behind the wheel of the new Panamera is that which only a Porsche can deliver. With its stunning ascending center console, it is unlike any other sedan one will see. This is due in large part to its sports car demeanor and heritage. The extremely short distance between the gear selector and the height- and reach-adjustable steering wheel lends itself to the sports car handling expected of a Porsche. A heated steering wheel is available as an option.

Add the optional gearshift paddles (p. 52) to the SportDesign steering wheel for an even sportier look.

Standard on all Panamera models is the multifunction steering wheel, which has buttons for the convenient operation of a range of audio and navigation functions. It is available in Smooth-Finish Leather or, in conjunction with steering-wheel heating, any finish of your choice: Walnut, Tineo, Anthracite Birch, Yachting Mahogany, or Carbon Fiber.

With these finishes and a selection of other materials offered in the form of predefined interior packages, there is a wealth of ways for you to personalize the interior. So you can create a performance or luxury feel, or even a blend of both. Detailed information on colors and personalization options can be found on pages 117–118 and onward.

All the frequently used controls on the center console are grouped logically together to enable you to select individual functions quickly and easily.

Just how much attention we have paid to providing space in the passenger compartment can be seen in the details. The Panamera models offer a variety of storage options, which includes the doors and center console. The front center armrest contains a convenient cupholder, and there are two additional fold-out cupholders installed above the glove compartment to supplement the two fitted as standard in the rear compartment.



Interior of the Panamera Turbo with multifunction steering wheel and Sport Chrono Package Turbo



Front cupholder



Glove compartment



8-way power seats (rear) with comfort headrests (in conjunction with large center console) in the Panamera Turbo

For extra storage space, a large rear center console is available as an option. Two 12-volt sockets and the preparation for the cooling compartment are included.

The interior lights with switch-off delay were designed with not only practicality in mind but also aesthetic appeal. This includes illuminated door handles and storage compartments in the front, orientation lighting, and front footwell lights. There are also reading lights

and interior lights—one of each for all four seats.

An optional interior lighting package designed specifically for rear passengers adds two reading lights to the overhead console, lights in each footwell, additional orientation lighting



in the rear, and illumination for door storage compartments and the compartment in the rear center console. Nearly all lights are powerful yet energy-efficient LEDs. The additional ambient lighting in the overhead consoles in the front and rear and the reading lights are dimmable.

The roof liner in Alcantara® is standard for the Turbo models and optional for the other models.

Thermally and noise-insulated glass can be fitted as an option, which will maintain your privacy and protect the interior from

the effects of strong sunlight. Also available as an option, the electric roll-up sunblinds on the rear side windows and behind the rear seats shade rear passengers.



Instruments in the Panamera Turbo

Instruments.

The five circular dashboard instruments in the Panamera models are quick, clear, and easy to read. Classic Porsche design.

The high-resolution, 4.8-inch TFT color screen in the instrument cluster gives you access to the onboard computer or the navigation system map, for example. It also shows the settings of the adaptive cruise control or, in the case of the Panamera S Hybrid, the real-time energy flow.

In the Panamera and Panamera 4, the dial face of the tachometer is black; in the Panamera S

models, it is silver-grey; and in the Panamera Turbo models, it is black and features the “turbo” or “turbo S” logos.

Front seats.

The front seats with integrated headrests offer a high degree of comfort. During cornering, they hold your body firm without restricting your freedom of movement.

Seat adjustment is fully electric as standard with controls on both the driver and front-passenger sides for seat height, seat cushion and backrest angle, and fore/aft position. The driver

memory package enables the driver seat and exterior mirror positions to be saved and restored automatically.

In the Panamera Turbo models, the front seats offer even more functionality. The 14-way power seats with memory package for driver and front passenger are standard (optional for all other Panamera models). In addition to featuring an electric steering-column adjustment, the package includes electric four-way lumbar support, electric seat-cushion length adjustment, and personal memory settings for seat, steering wheel, and mirror positions. The courtesy lights (LEDs in the exterior mirrors) are a component of the driver memory package and 14-way power seats with memory package.



Standard front seat



Adaptive Sport Seat (front)

Adaptive Sport Seats.

Do you wish to take sporty driving to an even higher level? That is precisely what the Adaptive Sport Seats were designed for. Available as an option for all Panamera models, they have firmer upholstery and provide even better lateral support, thanks to the raised side bolsters on the seat cushion and backrest.

Featuring 18-way electric adjustment, the seats can be optimally adapted to meet your needs in terms of seat height, cushion and backrest angle, cushion length, fore/aft adjustment, and four-way lumbar support. The steering column is also electrically adjustable.

In addition, the side bolsters on the seat cushion and backrest are independently adjustable for added comfort on long distances or precision lateral support on winding roads. Also included is the personal memory for the driver and front-passenger seats (including lumbar support), the steering wheel, and the driver’s exterior mirror.

Rear seats.

The rear compartment has two fully independent seats with plenty of leg and headroom, even for taller passengers. They provide good lateral support, even during fast cornering, with no compromise on comfort. Between the seats is a folding armrest with a handy storage compartment. The backrests fold down individually with a ratio of 40:60 to increase storage capacity or to accommodate larger items. With the optional large center console, the backrests can still be folded separately while the console itself remains fixed in position.

Eight-way power seats are available as an option for the rear in any of the Panamera models. In addition to the electric backrest adjustment, seat-cushion length adjustment, and lumbar support functions, there is a facility to adjust the front-passenger seat from the rear.

When specified in conjunction with seat ventilation, the 8-way power seats (rear) feature automatic comfort headrests. In conjunction with the Adaptive Sport Seats in the front, sport seats are also fitted in the rear and feature a contrasting seam pattern and elevated side bolsters.

LATCH child seat-mounting points are fitted as standard on both rear seats in all Panamera models.

Seat heating and ventilation.

The front seats of the Panamera S models and the Panamera Turbo models feature seat heating as standard (optional for the Panamera and Panamera 4). This heats the seat cushion and backrest to a pleasant temperature. In the Panamera Turbo models, the seats in the rear also have a heating function (optional for all other models).

On request, we can equip the front seats, indeed all four seats, with seat ventilation (only in conjunction with seat heating). A slipstream effect is produced by active ventilation of the perforated seat center and backrest and by passive aeration at the side bolsters. This evaporates perspiration moisture and therefore makes for a comfortable seating environment, even in hot weather. Seat heating and seat ventilation can be adjusted independently to any one of three power levels. Simultaneous ventilation and heating are possible.



Rear seats

As well as concentrating on performance, the mind needs to relax from time to time with something lighthearted.

Audio and communication.



Porsche Communication Management (PCM) with navigation module

Porsche Communication Management (PCM) with navigation module.

The Panamera models come equipped with the Porsche Communication Management (PCM) system as standard. PCM is the central control unit for audio, navigation, and communications. It is powerful and multifunctional, yet easy to operate.

The focal point is the intuitive seven-inch high-resolution touchscreen. Alternatively, you can also choose to operate the PCM using the conventional button controls. A maximum of five list entries per page ensures clarity of presentation. A help function is displayed at the bottom of the screen for further guidance in specific situations.

Radio functions include dynamic autostore, up to 42 memory presets, and FM dual-tuner frequency diversity with RDS, which continuously scans in the background for the best signal. The DVD drive plays CDs and audio DVDs, and is MP3-compatible. Audio playback of

video DVDs is also supported. A six-disc CD/DVD changer integrated in the center console is available as an option.

In terms of audio performance, a total output of 235 watts is produced through a combination of 11 loudspeakers. Fitted as standard in the Panamera Turbo (available as an option for Panamera S models), the Bose® Surround Sound system (p. 101) enables the playing of audio sources in the Dolby® Digital 5.1 format. For an even greater sound experience, the PCM can be combined with the optional Burmester® High-End Surround Sound System (p. 103).

Coming standard, the universal audio interface for the PCM enables you to connect an iPod® or, via the Aux-In or USB port, any other compatible MP3 player. The PCM can also be used to control the performance display of the optional Sport Chrono Package Plus (p. 65) or Sport Chrono Package Turbo (p. 67).

A navigation module with high-speed hard drive is included

with the PCM as standard. For route guidance, it is possible to select between a 2-D display and a bird's-eye view. In some regions, even land and buildings can be displayed in 3-D. The remaining journey distance is automatically adapted to the maximum screen size. Split-screen mode enables you to view two functions at once, such as the current navigation map and your next driving instructions.

Bluetooth® hands-free phone interface.

To enable a Bluetooth® connection for those mobile phones that only support the Hands-Free Profile (HFP), an interface is standard on all Panamera models. With HFP, the PCM acts as a hands-free system. The cell phone can remain tucked away and the PCM can be used to control functions of the hands-free phone interface.



Telephone module with cordless handset.

Alternatively, the optional built-in quad-band GSM telephone module provides better reception and exceptional sound quality, using the external vehicle antenna for mobile phones with Bluetooth® SIM Access Profile (SAP) or Bluetooth® Hands-Free Profile (HFP).

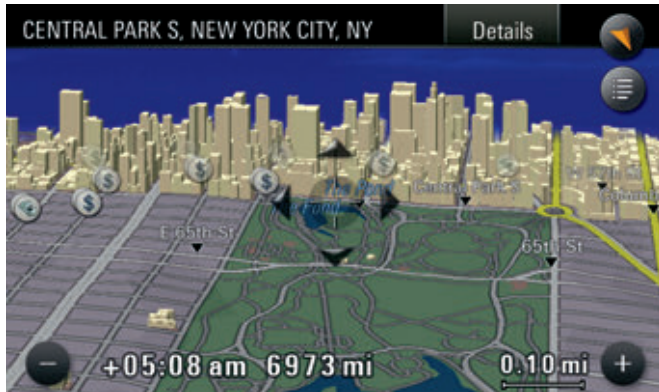

Electronic logbook.

An electronic logbook is available as an option. It enables automatic recording of mileage, route distance, date, time, starting location, and destination. Once you have downloaded the logbooks from the PCM via the USB or Bluetooth® interface, you can evaluate the data on your PC using the software supplied.

Universal audio interface.

The connectivity package, which comes standard in the front center console, contains all of your audio necessities: a USB, an Aux-In, and also a separate iPod® connection. Your iPod® or compatible MP3 player, or USB stick connected to the USB interface, can be controlled using the PCM.

Voice-control system.

The optional voice-control system is at your command with word-by-word input and without the tedious task of training it beforehand. Topic-related prompts make voice input even simpler. You can even browse through lists by voice command.



Universal audio interface

SiriusXM™ Satellite Radio receiver.

Only SiriusXM™ brings you more of what you love. The optional satellite radio service provides over 130 channels coast to coast, including commercial-free music, plus the best sports, news, talk, comedy, and entertainment. Welcome to the world of satellite radio.

Sports and stocks, also provided by SiriusXM™, give you customized updates on your favorite teams and stocks, so you can arrive at your destination well-informed. SiriusXM™ is standard on Panamera Turbo models.



SiriusXM™ Satellite Radio

NavTraffic®.

The optional (standard on Turbo models) NavTraffic® service, available with SiriusXM™, enables your vehicle's PCM to display continuously updated traffic information in over 130 markets. Avoid congestion before you reach it with information on traffic speed, accidents, construction, and road closings.



NavTraffic® and NavWeather®

NavWeather®.

The optional (standard on Turbo models) NavWeather® service, available with SiriusXM™, allows you to stay informed with driver-friendly weather information on your PCM screen. See storms and severe weather, keep track of weather warnings, and see the current conditions and 3-day forecasts.

*SiriusXM™ Radio requires a subscription, sold separately after any trial included with vehicle purchase or lease. **If you decide to continue your SiriusXM™ service at the end of your subscription, service will automatically renew and bill until you call SiriusXM™ at 1-866-635-2349 to cancel.** See SiriusXM™ Customer Agreement for complete terms at www.siriusxm.com. Satellite service available only to those at least 18 and older in the 48 contiguous United States and D.C. Sirius, XM, and all related marks and logos are trademarks of SiriusXM™ Radio Inc.



Porsche Rear Seat Entertainment

Porsche Rear Seat Entertainment.

You could always say you bought it for the kids: the Porsche Rear Seat Entertainment system. Available as an option through Porsche Exclusive before delivery of your Panamera.

The system comprises two display consoles, two multimedia players, and two wireless infrared headphones. Not only is it compatible with all standard

media formats (e.g., CD, DVD, MP3), but you can connect two separate, individually selectable AV sources, such as a game console or digital camera.

The system meets Porsche's stringent requirements for safety, ergonomics, and harmonious interior design. Each containing a swiveling seven-inch TFT screen, the screen consoles are finished in leather in the interior color and mounted on the front-seat backrests.

Your image of the world is also 360 degrees.

Bose® Surround Sound System.

For those times when you or your passengers would prefer music or news rather than the sound of the engine, there's the Bose® Surround Sound System.

It is fitted as the standard sound system in the Panamera Turbo models and available as an option for all other Panamera models.

The system comprises nine amplifier channels with a total output of 585 watts. Its 14 loudspeakers and 200-watt active subwoofer

deliver a balanced acoustic pattern and transform your Panamera into a concert hall.

In combination with the standard Porsche Communication Management (PCM), the Bose® Surround Sound System enables playback of audio DVDs and is thus able to make full use of the impressive sound spectrum of 5.1 digital recordings. Of course, you can still play other audio sources such as CDs and MP3s, in stereo, or at the push of a button, in one of the virtual

surround modes generated by Bose® Centerpoint® 2.

The Bose® patented AudioPilot® Noise Compensation Technology uses a microphone to continuously measure the ambient noise inside the vehicle and adapts music playback automatically so that a consistent sound impression is maintained, whatever the driving conditions.

As an innovator in the field, Bose® has used its considerable experience to adapt the system specifically to the passenger compartment of the Panamera.



Thanks to signal processing technologies developed by Bose® for automotive applications, it has been possible to achieve optimal acoustics by

tailoring the system to suit the layout of the vehicle interior.

The result is a balanced, faithfully reproduced sound and captivating 360-degree

acoustic experience delivered to all four seat positions. It's just a pity that, as the driver, leaning back and closing your eyes is not an option.

*On the Panamera S Hybrid, the subwoofer of the Bose® Surround Sound System is located below the loading edge and consequently reduces the luggage compartment capacity.

**“Made in Germany” is a sign of quality.
Not just when it comes to sports cars.**

The Burmester® High-End Surround Sound System.



The sound developed by our research center in Weissach is amplified by a sound from Berlin. We're talking about Burmester®, a custom audio manufacturer based in Berlin and one of the most respected premium audio manufacturers in the world. The Burmester® High-End Surround Sound System is available as an option for all Panamera models.

The technologies behind the system are on level with the finest of the Burmester® premium home audio systems,

showcasing state-of-the-art technology and featured in a Grand Touring Automobile for the first time. The effort is uncompromising, the craftsmanship excellent, the sound phenomenal. The system owes its superiority to countless details, and one goal: perfection in sound.

As early as the Panamera concept phase, Porsche and Burmester® had already embarked on a close collaboration in order

to determine the optimal installation locations for the special loudspeakers. Never before has such a large and acoustically effective total diaphragm surface area been used in a production vehicle and integrated to such perfection.

The system has 16 amplifier channels with a total output of more than 1,000 watts, 16 loudspeakers including an active subwoofer with a 300-watt Class D amplifier, a total diaphragm surface area of more than 2.5 square feet, and a frequency response of 30 Hz to 20 kHz.

Conceptually, we have broken entirely new ground. Crossover technology has been carried over more or less unmodified from the home audio sector. Analog and digital filters have been optimally defined for their new installation locations and finely tuned after extensive in-car audio testing.



The tweeters are ribbon-based Air Motion Transformers (AMT) that have been designed specifically for the Panamera, for unmistakably fine, clear, and undistorted high-frequency sound reproduction with excellent level stability. All loudspeaker housings are perfectly matched and deliver superior bass foundation,

definition, and impulse accuracy. As yet unequalled, the result is a natural and richly textured spatial sound. All of which is achieved, despite the system's remarkably low overall weight, thanks to intelligent Burmester® lightweight technology.

Furthermore, the elegantly pure design with galvanized surrounds and Burmester® logos

on selected loudspeakers makes it clear that the appeal of the Burmester® High-End Surround Sound System is as much about the visual as it is the audio.

Additional comfort and convenience features go hand in hand.

Automatic climate control.

Automatic climate control is standard in all models. Temperature and airflow volume, speed, and direction can therefore be set individually for the driver and front-passenger seat positions. An active carbon filter traps particles, pollen, and odors, and

an automatic air-recirculation function permanently monitors air quality, reduces humidity, and switches from fresh to recirculated air when required. Even the glove compartment is actively cooled when necessary. With the ignition switched off, it is also possible to use the residual heat of the engine to heat the passenger compartment for up to 20 minutes.

Four-zone climate control is available for all models as an option. With this feature, the driver has access to separate controls for both seat positions in the rear. A control panel on the rear center console also enables the rear passengers to select their own climate control settings for their respective seat positions, independently of the settings in the front compartment.



Air vents in center console



Four-zone climate control



Air-vent in rear



Four-zone climate control in rear compartment

Thermally and noise-insulated laminated glass.

All Panamera models are equipped as standard with tinted heat-insulating glass and a grey top-tint on the windshield. Available as an option is a thermally and noise-insulated laminated glass for all-around more efficient reflection of infrared radiation and enhanced protection against noise. Enjoy an even more pleasant climate and peace in the passenger compartment.

Water-repellent side windows.

The front side windows of the Panamera model range have been treated with a water-repellent coating so that not only water but also dirt runs off more easily, thereby providing optimal visibility, even in poor weather. (Note: Surface finish requires occasional renewal depending on vehicle usage.)

Wiper system with rain sensor.

The windshield wiper system has two wiper speeds with an intermittent wipe. A rain sensor controls the wipers automatically and with adjustable sensitivity. A rear wiper is available as an option (standard on the Panamera S Hybrid).



Reversing camera display in PCM

HomeLink®.

HomeLink® is a programmable garage door opener integrated into the overhead console. At the push of a button, it controls up to three different garage doors, lighting systems, or alarm systems.

ParkAssist.

ParkAssist is standard in all Panamera models. With four inconspicuous sensors in the rear end, it audibly alerts the driver when detecting an obstacle behind the vehicle. An intermittent warning tone increases in rapidity as the

obstacle is approached. Convenient and safe.

An enhanced version of ParkAssist, which includes six sensors in the front end, is fitted as standard in the Panamera Turbo and Panamera Turbo S and is available as an option in

the other models. The audible alert is supplemented by a visual warning in the central display screen, which provides a graphical representation of the vehicle's proximity to obstacles.

Reversing camera.

The optional reversing camera (only in conjunction with ParkAssist—front and rear) facilitates precise reverse parking and maneuvering and also assists in hitching a trailer. Help is provided in the form of the

camera image and the dynamic, superimposed guidelines on the PCM screen, which illustrate the predicted course of the vehicle given the current position of the steering wheel.

Lane Change Assist (LCA).

The optional Lane Change Assist* uses radar sensors to monitor the area behind the vehicle as well as the blind spot. At speeds of 18 mph and above, the system alerts the driver if it detects a vehicle in the blind spot or

approaching quickly from behind. This is done in the form of a visual warning in the exterior mirrors. This enhances comfort and safety, particularly when driving on the highway. However, LCA does not actively intervene to control the vehicle and can be deactivated at any time.

*Available from 09/2011 at the earliest.

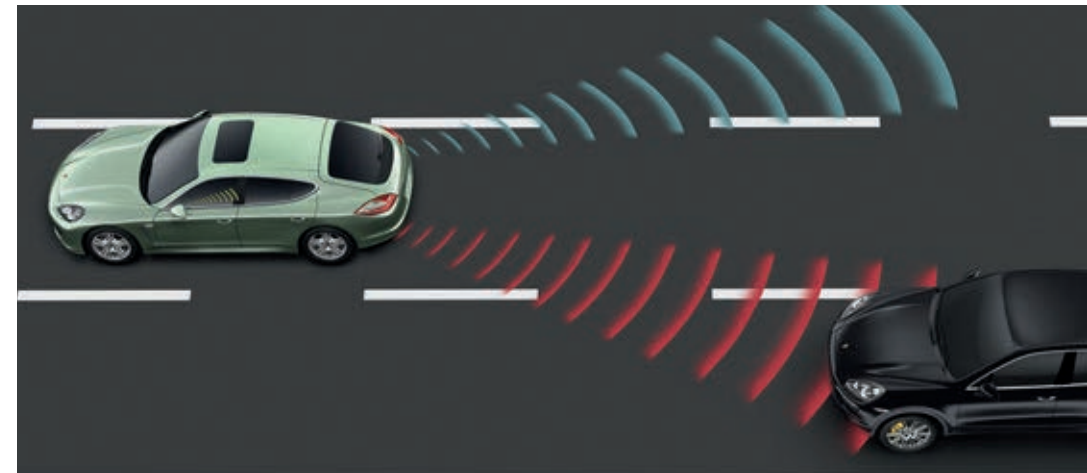

Lane Change Assist



Adaptive cruise control

Cruise control.

Cruise control is fitted as standard for added driver comfort on long stretches of road. Cruise control operates at speeds greater than 20 mph and is selected by using a button on the steering-column control stalk.

Adaptive cruise control.

Available as an option, this enhanced version of cruise control regulates the speed of your vehicle in line with the speed of the vehicle in front. A radar sensor inside the front center air intake scans the road ahead up to a distance of 650 feet. If you've selected a cruising speed but have begun to gain on the vehicle in front because it is driving more slowly, this is detected by the radar sensor.

The system now gently reduces the speed of your vehicle by restricting the throttle or gently applying the brakes. This continues until the distance that you have preset is maintained. Your vehicle will now follow the one in front at a reduced speed. If the other vehicle decelerates further, adaptive cruise control will continue to reduce your cruising speed—even down to a halt. If heavier braking is required, the driver will have to intervene manually.

As soon as the road ahead clears, your vehicle will accelerate back up to the cruising speed originally set.

Slide/tilt moonroof.

Standard on all Panamera models. It is made from tinted toughened safety glass and features a manually adjustable sliding sunscreen and remote closing function.

Porsche Entry & Drive.

Standard in the Panamera Turbo models and optional for all other Panamera models, Porsche Entry & Drive is recognizable from the chrome surfaces on the door handles. Fumbling for your key is now a thing of the past.

Why? As soon as you touch the door handle, the system automatically checks the encrypted access code on the key in your pocket. Once the key is validated, the door unlocks. The engine can then be started and switched off using the electronic ignition switch.

To lock the vehicle, you simply press a button on the outside of the door handle. Porsche Entry & Drive then locks the vehicle and activates the engine immobilizer and steering-column lock.

Anti-theft protection.

As standard, the Panamera models are protected by an immobilizer and an alarm system with ultrasonic interior surveillance. The system secures all four doors, the hood, the rear hatch, the passenger compartment, the ignition, and any trailer that may be attached.

For additional security, as soon as you remove the key, an electromechanical lock engages the steering column.



Slide/tilt moonroof

It carries your cargo. And 60 years of tradition.

Luggage compartment.



Luggage compartment with rear seat folded down



Luggage compartment of the Panamera S Hybrid with optional Bose® Surround Sound System

Four adults, luggage for four, one sports car. It really does work.

The luggage compartments in the Panamera, Panamera 4, Panamera S, and Panamera 4S

models have a capacity of 15.7 cubic feet. In conjunction with the Bose® Surround Sound System or Burmester® High-End Surround Sound System, they offer 15.26 cubic feet of luggage

space, equal to the luggage capacity of the Panamera Turbo models. The Panamera S Hybrid has a luggage compartment capacity of 11.8 cubic feet, or 11.2 cubic feet* if the optional Bose® Surround Sound System is installed. Ample space, for example, for four suitcases available from the Porsche Design Driver's Selection range—color-coordinated with the vehicle's exterior color if you wish. What makes the storage space special is that the four suitcases can be stowed in such a way that you can remove whichever one you choose with ease—no reshuffling required. They can then be concealed using the retractable luggage compartment cover (fitted as standard) or the optional removable luggage compartment cover.

The key to this solution is the extraordinary height of the luggage compartment, achieved



through the special geometry of the rear lid and the large rear window. The wide opening angle of the rear lid facilitates convenient loading.

A rarely encountered feature in this vehicle class is the fully or split-folding rear seats. In the cargo position, the available luggage capacity in the

Panamera, Panamera 4, Panamera S, and Panamera 4S increases to 44.60 cubic feet. In conjunction with the Bose® Surround Sound system or Burmester® High-End Surround Sound System, the luggage compartment has a capacity of 44.14 cubic feet, equal to that of the Panamera Turbo models. The Panamera S Hybrid has a capacity

of 40.7 cubic feet or 40 cubic feet* if the Bose® Surround Sound system is installed.

A ski bag is available as an option and, to accommodate it, the center section between the rear seats folds separately.

*On the Panamera S Hybrid, the subwoofer of the Bose® Surround Sound System is located below the loading edge and consequently reduces the luggage compartment capacity.



Luggage compartment with retractable luggage compartment cover

The contents of the luggage compartment can be concealed using the detachable retractable luggage compartment cover provided as standard.

For extra protection, you could select the optional removable luggage compartment cover, which lifts up when the rear lid is opened, at which point it can be taken out.

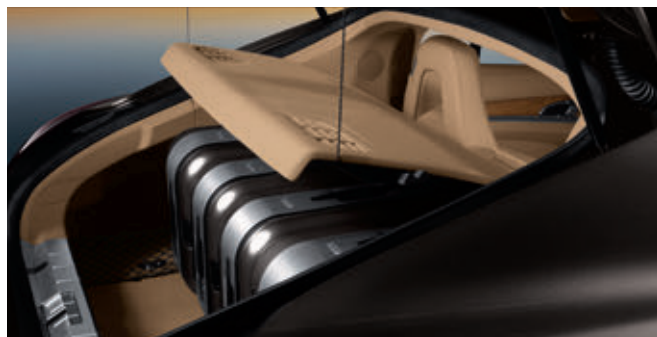

Luggage compartment with removable luggage compartment cover

A roll-up sunblind offered as an option is compatible with either luggage cover. Controlled electrically, it can be raised behind the rear seats for extra privacy.



Electric roll-up sunblind for behind the rear compartment





Roof Transport System

Rear lid.

The rear lid is made of lightweight aluminum. It unlocks in response to the remote control, the switch on the driver door, or the concealed latch handle. Top-hinged, it features a wide opening for comfortable loading, and an electric soft-closing function facilitates closing.

Power liftgate.

A power liftgate with user-programmable opening height is standard on all Panamera models. It closes automatically when the button on the rear lid itself is pressed, and also opens in response to the dedicated button on the key remote and in the interior.

Roof Transport System.

A luggage compartment capacity of 15.7 cubic feet (up to 44.6 cubic feet with rear seat folded) is plenty, you would have thought. You want more? No problem. An integrated roof rail system enables you to fit the optional Roof Transport System. It is then ready to hold any of the popular roof attachments available from Porsche Tequipment, e.g., ski holders or roof boxes. All load-carrying components are made of aluminum. Maximum roof load: 165 pounds.

Express your individuality.

Colors.

The extensive color range of the Panamera models offers no fewer than 16 exterior colors. In total, there are two solid, nine metallic, and five special colors to choose from. An additional metallic color—Agate Grey Metallic—is available for the Panamera Turbo S. Then there are seven interior colors, five

two-tone combinations, two additional two-tone combinations exclusively for the Panamera Turbo S, plus eight interior packages in Aluminum, Carbon Fiber, or a selection of woods.

If you can't find the color you'd like for your Panamera model, we can probably mix it for

you. For more information, see the Porsche Exclusive Panamera catalog.

The Porsche Car Configurator at [porscheusa.com](https://www.porscheusa.com) allows you to see how the available colors would look on your car, not only on the exterior, but in the interior, too.

It's a Porsche.

Of course you are going to take it personally.

Personalization.

The standard specification of the Panamera model range may be second to none, but Porsche still gives you the opportunity to personalize your car to your own taste. There is a comprehensive range of individual items and equipment packages to choose from. For both the exterior and interior.

These are not the only ways to style your Panamera to your personal preference. How about personalizing your car at the factory through Porsche Exclusive, or why not consider our range of aftermarket accessories from Porsche Tequipment? Your Authorized Porsche dealer will be happy to advise you.





Slide/tilt moonroof



ParkAssist (front)



Rear wiper

The vehicles illustrated in the chapter on personalization may include additional options not featured in this catalog. For information on these options, please consult your Authorized Porsche dealer.

Option

Exterior.

Option	Panamera	Panamera 4	Panamera S	Panamera 4S	Panamera S Hybrid	Panamera Turbo	Panamera Turbo S	Code	Page
• Metallic paint (no cost on Turbos)	○	○	○	○	○	●	●	Code	158
• Special colors	○	○	○	○	○	○	○	Code	158
• Colors to sample	○	○	○	○	○	○	○	Code	
• SportDesign package	○	○	○	○	○	○	○	XAP	
• Side skirts	○	○	○	○	○	○	●	XAR	28
• Exterior package in black (high-gloss)	○	○	○	○	○	○	○	806	
• Porsche Entry & Drive	○	○	○	○	○	●	●	625	110
• Bi-Xenon™ headlights	●	●	●	●	●	●	●	601	71
• Bi-Xenon™ headlights including Porsche Dynamic Light System (PDLS)	○	○	●	●	●	●	●	603	
• Automatically dimming exterior and interior mirrors	○	○	●	●	●	●	●	260/261	
• Deletion of model designation	A	A	A	A	A	A	A	498	
• ParkAssist (front and rear)	○	○	○	○	○	●	●	636	107
• ParkAssist (front and rear) with reversing camera	○	○	○	○	○	○	○	638	107
• Privacy glazing	○	○	○	○	○	○	○	866	90
• Thermally and noise-insulated glass	○	○	○	○	○	○	○	865	106
• Thermally and noise-insulated glass including privacy glazing	○	○	○	○	○	○	○	864	
• Electric slide/tilt glass moonroof	○	○	○	○	○	○	○	650	109–110, 119
• Rear wiper	○	○	○	○	○	●	○	425	106, 119
• Roof Transport System	○	○	○	○	○	○	○	549	116
• Automatic rear lid	●	●	●	●	●	●	●	867	116

– not available ○ optional equipment ● standard A available at no extra cost

Option

Engine, transmission, and chassis.

	Panamera	Panamera 4	Panamera S	Panamera 4S	Panamera S Hybrid	Panamera Turbo	Panamera Turbo S	Code	Page
• Porsche Doppelkupplung (PDK) with Auto Start Stop function	•	•	•	•	–	•	•	250	20
• Tiptronic S	–	–	–	–	•	–	–	450	49
• Porsche Ceramic Composite Brakes (PCCB)	○	○	○	○	○	○	○	450	75, 122
• Porsche Active Suspension Management (PASM)	○	○	•	•	•	•	•	475	59
• Adaptive air suspension with PASM	○	○	○	○	•	•	•	350/351	60
• Porsche Dynamic Chassis Control (PDCC) with Porsche Torque Vectoring Plus (PTV Plus)	○	○	○	○	–	○	•	712	61
• Servotronic	○	○	○	○	•	○	•	658	57
• Sport Chrono Package Plus	○	○	○	○	○	–	–	640	65
• Sport Chrono Package Turbo	–	–	–	–	–	○	•	640	67
• Sport exhaust system	○	○	○	○	–	○	•	176/XLF	46, 122
• Sport tailpipe	○	○	○	○	–	○	○	XLR	122
• Tire Pressure Monitoring System (TPMS)	•	•	•	•	•	•	•	482	58
• Turbo Powerkit	–	–	–	–	–	○	–	X80	



Porsche Ceramic Composite Brakes (PCCB)



Sport Chrono Package Turbo



Sport exhaust system on the Panamera, Panamera 4, Panamera S, Panamera 4S, and Panamera Turbo



Sport tailpipes

The vehicles illustrated in the chapter on personalization may include additional options not featured in this catalog. For information on these options, please consult your Authorized Porsche dealer.

– not available ○ optional equipment • standard A available at no extra cost



Panamera with 20-inch 911 Turbo II wheels



18-inch Panamera S wheel



19-inch Panamera Turbo wheel



19-inch Panamera Design wheel



20-inch RS Spyder Design wheel



20-inch 911 Turbo II wheel



20-inch Panamera Sport wheel

Option

Wheels.

Option	Panamera	Panamera 4	Panamera S	Panamera 4S	Panamera S Hybrid	Panamera Turbo	Panamera Turbo S	Code	Page
• 18-inch Panamera wheels	•	•	A	A	A	—	—		58
• 18-inch Panamera S wheels	○	○	•	•	•	—	—	413	58, 123
• 19-inch Panamera Turbo wheels	○	○	○	○	○	•	•	415	58, 123
• 19-inch Panamera Design wheels	○	○	○	○	○	○	A	416	123
• 20-inch RS Spyder Design wheels	○	○	○	○	○	○	A	417	123
• 20-inch 911 Turbo II wheels	○	○	○	○	○	○	A	418	58, 123
• 20-inch Panamera Sport wheels	○	○	○	○	○	○	○	XRW	123
• 20-inch Panamera Sport wheels, painted	○	○	○	○	○	○	○	XRX	
• 20-inch Panamera Sport wheels, painted black	○	○	○	○	○	○	○	XRY	
• Wheel centers with full-color Porsche Crest	○	○	○	○	○	○	•	446	
• All-season tires for 19-inch alloy wheels	A	A	A	A	A	A	A	415/416	
• All-season tires for 19-inch alloy wheels (low rolling-resistance version)	○	○	○	○	○	○	○	237	58
• Spacers for rear axle, 5 mm	○	○	○	○	○	○	•	CRP	

The vehicles illustrated in the chapter on personalization may include additional options not featured in this catalog. For information on these options, please consult your Authorized Porsche dealer.

— not available ○ optional equipment • standard A available at no extra cost

Option	Panamera	Panamera 4	Panamera S	Panamera 4S	Panamera S Hybrid	Panamera Turbo	Panamera Turbo S	Code	Page
Interior.									
• Rear interior lighting package	○	○	○	○	○	○	○	630	18, 126
• HomeLink®	●	●	●	●	●	●	●	608	107
• Multifunction steering wheel	●	●	●	●	●	●	●	844	51, 87
• SportDesign steering wheel	○	○	○	○	○	○	○	840	52
• Steering-wheel heating	○	○	○	○	○	○	○	345	
• Adaptive cruise control	○	○	○	○	○	○	○	456	109, 126
• Lane Change Assist	○	○	○	○	○	○	○	457	108
• Driver memory package	●	●	●	●	●	●	—	537	91
• 14-way power seats with memory package	○	○	○	○	○	●	●	P80	91, 126
• Adaptive Sport Seats with memory package	○	○	○	○	○	○	○	P81	92
• 8-way power seats (rear)	○	○	○	○	○	○	○	834	93
• 8-way power seats (rear) with comfort headrests	○	○	○	○	○	○	○	834	93, 127
• 8-way power seats (rear) (in conjunction with large center console)	○	○	○	○	○	○	○	836	
• 8-way power seats (rear) with comfort headrests (in conjunction with large center console)	○	○	○	○	○	○	○	836	89
• 8-way power seats (rear) (in conjunction with Adaptive Sport Seats)	○	○	○	○	○	○	○	835	



Adaptive cruise control



14-way power seats with memory package



Rear interior lighting package

The vehicles illustrated in the chapter on personalization may include additional options not featured in this catalog. For information on these options, please consult your Authorized Porsche dealer.

— not available ○ optional equipment ● standard A available at no extra cost



Four-zone climate control



8-way power seats (rear) with seat ventilation and comfort headrests, large rear center console

The vehicles illustrated in the chapter on personalization may include additional options not featured in this catalog. For information on these options, please consult your Authorized Porsche dealer.

Option

Interior.

Option	Panamera	Panamera 4	Panamera S	Panamera 4S	Panamera S Hybrid	Panamera Turbo	Panamera Turbo S	Code	Page
• Side airbags in the rear compartment	•	•	•	•	•	•	•	565	78
• Seat heating (front)	○	○	•	•	•	–	–	342	93
• Seat heating (front and rear)	○	○	○	○	○	•	•	343	93
• Seat ventilation (front)	○	○	○	○	○	○	○	541	93
• Seat ventilation (front and rear)	○	○	○	○	○	○	○	542	93
• Removable luggage compartment cover	○	○	○	○	○	○	○	869	113
• Ski bag	○	○	○	○	○	○	○	213	112
• Floor mats	•	•	•	•	•	•	•	810	
• Four-zone climate control	○	○	○	○	○	○	○	576	105, 127
• Auxiliary heating	○	○	○	○	–	○	○	851	
• Fire extinguisher	○	○	○	○	○	○	○	509	
• Large rear center console	○	○	○	○	○	○	○	838	89, 127
• Cooling compartment in the rear	○	○	○	○	○	○	○	CZK	
• Electric roll-up sunblind for behind rear compartment	○	○	○	○	○	○	○	862	18, 90
• Electric roll-up sunblind for rear side windows	○	○	○	○	○	○	○	861	
• Two fold-out cupholders above glove compartment	A	A	A	A	A	A	A	585	87

– not available ○ optional equipment • standard A available at no extra cost

Option	Panamera	Panamera 4	Panamera S	Panamera 4S	Panamera S Hybrid	Panamera Turbo	Panamera Turbo S	Code	Page
Interior: leather and natural leather.									
• Leather interior									
– Smooth-Finish Leather in standard color	○	○	○	○	○	●	A	Code	22, 30
– in two-tone combination	○	○	○	○	○	○		● Code	130, 132
– in natural leather	○	○	○	○	○	○		Code	156
– in two-tone combination natural leather	○	○	○	○	○	○		Code	133, 156
• Soft ruffled leather on seats (in conjunction with standard interior)	○	○	○	○	○	–	–	947	
• Soft ruffled leather on seats (in conjunction with leather interior)	○	○	○	○	○	○		982	
• Roof liner in Alcantara®	○	○	○	○	○	●	●	594	90
• Porsche Crest embossed on headrests (front)	○	○	○	○	○	○	●	XYV	
• Porsche Crest embossed on headrests (front and rear)	○	○	○	○	○	○		XYW	
Black (high-gloss) interior.									
• Black (high-gloss) interior package	●	●	●	●	●	A	A	817	22
Yachting Mahogany interior.									
• Yachting Mahogany interior package	○	○	○	○	○	○		XZY	130
• Heated multifunction steering wheel in Yachting Mahogany	○	○	○	○	○	○		XZZ	87
• Roof liner grab rails in Yachting Mahogany	○	○	○	○	○	○		CZH	



Interior in two-tone combination (Marsala Red and Cream), Carbon Fiber interior package, and other optional equipment



Interior in two-tone combination (Yachting Blue and Cream), Yachting Mahogany interior package, and other optional equipment

The vehicles illustrated in the chapter on personalization may include additional options not featured in this catalog. For information on these options, please consult your Authorized Porsche dealer.

– not available ○ optional equipment ● standard A available at no extra cost

Option	Panamera	Panamera 4	Panamera S	Panamera 4S	Panamera S Hybrid	Panamera Turbo	Panamera Turbo S	Code	Page
Walnut interior.									
• Walnut interior package	○	○	○	○	○	●	A	821	133
• Heated multifunction steering wheel in Walnut	○	○	○	○	○	○	○	842	87
Tineo interior.									
• Tineo interior package	○	○	○	○	○	A	A	822	133
• Heated multifunction steering wheel in Tineo	○	○	○	○	○	○	○	849	87
Anthracite Birch interior.									
• Anthracite Birch interior package	○	○	○	○	○	A	●	823	133
• Heated multifunction steering wheel in Anthracite Birch	○	○	○	○	○	○	○	848	87
Natural Olive interior.									
• Natural Olive interior package (Ash in Olive Grain)	○	○	○	○	○	○	○	824	133
Carbon Fiber interior.									
• Carbon Fiber interior package	○	○	○	○	○	○	○	819	130, 134
• Heated multifunction steering wheel in Carbon Fiber	○	○	○	○	○	○	○	845	87
Aluminum interior.									
• Brushed Aluminum interior package	○	○	○	○	○	A	A	818	26, 134
• PDK gear selector in Aluminum	○	○	○	○	○	○	○	XYA	51
• Additional door-entry guards in Brushed Aluminum	○	○	○	○	○	○	○	597	



Interior in two-tone combination (Yachting Blue and Cream), Anthracite Birch interior package with other optional equipment



Interior in Luxor Beige, Natural Olive interior package with other optional equipment

The vehicles illustrated in the chapter on personalization may include additional options not featured in this catalog. For information on these options, please consult your Authorized Porsche dealer.

– not available ○ optional equipment ● standard A available at no extra cost



Interior in Platinum Grey, Walnut interior package with other optional equipment



Interior in two-tone combination (Luxor Beige and Yachting Blue), Carbon Fiber interior package with other optional equipment



Interior in two-tone combination (Cognac and Cedar natural leather), Tineo interior package with other optional equipment



Leather interior in Yachting Blue, Brushed Aluminum interior package with other optional equipment

Option	Panamera	Panamera 4	Panamera S	Panamera 4S	Panamera S Hybrid	Panamera Turbo	Panamera Turbo S	Code	Page
Audio and communication options for vehicles with PCM.									
• Porsche Communication Management (PCM) with navigation module	●	●	●	●	●	●	●		96
• Electronic logbook	○	○	○	○	○	○	○	641	98
• Voice-control system	○	○	○	○	○	○	○	671	98
• Bluetooth® hands-free phone interface	●	●	●	●	●	●	●	619	97
• Telephone module with cordless handset	○	○	○	○	○	○	○	669	97, 136
• Additional charging cradle for active handset in the rear compartment	○	○	○	○	○	○	○	626	
• Porsche Rear Seat Entertainment	○	○	○	○	○	○	○	CEU	100
• Bose® Surround Sound system	○	○	○	○	○	●	●		101
• Burmester® High-End Surround Sound System	○	○	○	○	—	○	○	682	103
• Six-disc CD/DVD changer*	○	○	○	○	○	○	○	693	96, 100
• Universal audio interface (AUX, USB, iPod®)**	●	●	●	●	●	●	●	870	98
• SiriusXM Satellite Radio™ receiver	○	○	○	○	○	●	●	686	



Cordless handset



Bose® Surround Sound system



Burmester® High-End Surround Sound System

The vehicles illustrated in the chapter on personalization may include additional options not featured in this catalog. For information on these options, please consult your Authorized Porsche dealer.

*May be incompatible with some copy-protected CDs.

**For information on compatibility with iPod® models, please contact your Authorized Porsche dealer.

— not available ○ optional equipment ● standard A available at no extra cost



Porsche Exclusive

Let your car reflect your character.

With the range of options featured in this catalog, you can make your Porsche even more special. Introducing Porsche Exclusive. Have your vehicle individually and

exclusively tailored to your wishes, even before it leaves the factory. Aesthetically and technically, inside and outside, using fine materials and with customary Porsche quality.

Our overriding principle? That your car is uniquely handcrafted to your taste. You will find a wide range of design options in the

separate Porsche Exclusive Panamera catalog.

Your Porsche dealer will be happy to answer any questions about the Porsche Exclusive program that you may have. Please note that delivery times may be extended for certain Porsche Exclusive options.

Porsche Tourist Delivery

Come and collect your new Panamera directly from the Porsche factory in which it was made, and enjoy a nearly five-hour experience in the fascinating world of Porsche.

Start with an in-depth factory tour and then venture to the Customer Center. Here, we will introduce you to the history of Porsche and to the latest Porsche vehicles. A visit to the Track Control Center provides a spectacular view of what's going on out on the test track.

A three-course meal in our restaurant is also included.

A professional Porsche instructor will explain all the finer details about your vehicle on the factory's own test track. Race down the straights, steer hard into the hairpins, and weave your way through the chicanes—always under the expert supervision of one of our motorsport professionals.

The end of your experience day, which you can share with up to two companions, culminates in

the handover of your vehicle. Fully fueled, of course.

You now have up to two weeks to tour Europe in your new Porsche. Upon the conclusion of your trip, drop off your vehicle at the factory or any of the alternate drop-off points, and we will ship your vehicle back to your U.S. dealer.





Porsche Tourist Delivery

Imagine touring the original factory and then being handed the keys for an even more gratifying opportunity: touring Europe in your brand-new Porsche. What happens next is up to you. Contact your local Porsche dealer for more information.

Porsche Roadside Assistance

Your ownership experience is enhanced with complimentary enrollment in the Porsche 24-Hour Roadside Assistance program. It includes coverage 24 hours a day, 365 days a year, for the duration of your warranty. Contact your Porsche dealer for specifics.

Porsche Financial Services

Competitive, convenient, and carefully crafted financing options can be customized to meet your needs. Ask your certified Porsche Sales Consultant for details.

Porsche Exclusive

Realize your vision of the perfect Porsche with our factory customization program. From styling enhancements to performance upgrades, all modifications are uniquely handcrafted for your Porsche.

Porsche Tequipment

Personalize your Porsche at any time after purchase with the Tequipment range of approved accessories. Designed exclusively for your Porsche, every product is fully guaranteed.

Porsche Design Driver's Selection

Our distinctive collection of clothing and accessories combines timeless elegance with unmistakable quality. Visit your local Porsche dealer or shop online at porscheusa.com/shop.

Service

Porsche Approved Pre-Owned

Only the best Porsche cars earn the right to be called "Certified." A meticulous 111-point inspection, a 2-year or 50,000-mile Limited Warranty, and 24-Hour Roadside Assistance make this program one of a kind. Contact your Porsche dealer for details.

Porsche Classic

Your specialist source for genuine Porsche parts and technical documentation, as well as servicing, repair, and restoration for all types of Porsche classics. For more information, visit porscheusa.com/classic.

Christophorus

Our bimonthly magazine for Porsche owners is packed with news, articles, and exclusive interviews covering every aspect of Porsche automobiles and the Porsche lifestyle.

Porsche Clubs

With more than 120,000 members worldwide in 60 countries, know you are not alone in your passion for Porsche. Learn more about the brand and meet other Porsche enthusiasts just like yourself. Visit porscheusa.com for more information.

Porsche Driving Experience

1. Porsche Travel Club. Exclusive driving holidays and incentive ideas combining luxury and adventure, worldwide. To find out more, contact us by e-mail at travel.club@porsche.us.

2. Porsche Sport Driving School.

Develop your skill and explore your Porsche with the Porsche Sport Driving School. Learn firsthand from famed Porsche Racing drivers while they teach you at a world-class racing facility. Visit porschedriving.com for more information.



Porsche Online

For all the latest news and information from Porsche, go to porscheusa.com.

Follow us on:





Summary

Four doors. Four seats. Sports car technology for four. With luggage and without compromise. This is our contribution to the premium class. Or more precisely, to driving in the premium class. We've discovered that some extra-sporty dynamics wouldn't go amiss.

Technical data

		Panamera	Panamera 4
Engine			
Cylinders		6	6
Displacement		3.6 liters	3.6 liters
Max. power at rpm		300 hp @ 6200 rpm	300 hp @ 6200 rpm
Max. torque at rpm		295 lb.-ft. @ 3750 rpm	295 lb.-ft. @ 3750 rpm
Compression ratio		12.5:1	12.5:1
Transmission			
Layout		Rear-wheel drive	Active all-wheel drive
PDK (7-speed)		Standard	Standard
Chassis			
Front axle		Fully independent large-format double-wishbone suspension	Fully independent large-format double-wishbone suspension
Rear axle		Fully independent multi-link suspension	Fully independent multi-link suspension
Steering		Power-assist (hydraulic)	Power-assist (hydraulic)
Brakes		Six-piston, aluminum monobloc fixed brake calipers at front, four-piston, aluminum monobloc brakes at rear, internally vented discs, ABS	Six-piston, aluminum monobloc fixed brake calipers at front, four-piston, aluminum monobloc brakes at rear, internally vented discs, ABS
Wheels	Front: Rear:	8J x 18 ET 59 9J x 18 ET 53	8J x 18 ET 59 9J x 18 ET 53
Tires	Front: Rear:	245/50 ZR 18 275/45 ZR 18	245/50 ZR 18 275/45 ZR 18

		Panamera S	
Engine			
Cylinders		8	
Displacement		4.8 liters	
Max. power at rpm		400 hp @ 6500 rpm	
Max. torque at rpm		369 lb.-ft. @ 3500–5000 rpm	
Compression ratio		12.5:1	
Transmission			
Layout		Rear-wheel drive	
PDK (7-speed)		Standard	
Chassis			
Front axle		Fully independent large-format double-wishbone suspension	
Rear axle		Fully independent multi-link suspension	
Steering		Power-assist (hydraulic)	
Brakes		Six-piston, aluminum monobloc fixed brake calipers at front, four-piston, aluminum monobloc brakes at rear, internally vented discs, ABS	
Wheels	Front: Rear:	8J x 18 ET 59 9J x 18 ET 53	
Tires	Front: Rear:	245/50 ZR 18 275/45 ZR 18	

Engine	Panamera 4S	Panamera S Hybrid
Cylinders	8	6
Displacement	4.8 liters	3.0 liters
Max. power at rpm	400 hp @ 6500 rpm	333 hp @ 5500–6500 rpm
Max. torque at rpm	369 lb.-ft. @ 3500–5000 rpm	324 lb.-ft. @ 3000–5250 rpm
Compression ratio	12.5:1	10.5:1
Max. power of electric motor at rpm	–	47 hp >1150
Max. torque of electric motor at rpm	–	221 lb.-ft. @ <1150 rpm
Max. power of parallel full hybrid at rpm	–	380 hp @ 5500 rpm
Max. torque of parallel full hybrid at rpm	–	428 lb.-ft. @ 1000 rpm
Transmission		
Layout	Active all-wheel drive	Rear-wheel drive
Tiptronic S (8-speed)	–	Standard
PDK (7-speed)	Standard	–
Chassis		
Front axle	Fully independent large-format double-wishbone suspension	Fully independent large-format double-wishbone suspension
Rear axle	Fully independent multi-link suspension	Fully independent multi-link suspension
Steering	Power-assist (hydraulic)	Power-assist (hydraulic)
Brakes	Six-piston, aluminum monobloc fixed brake calipers at front, four-piston, aluminum monobloc brakes at rear, internally vented discs, ABS	Six-piston, aluminum monobloc fixed brake calipers at front, four-piston, aluminum monobloc brakes at rear, internally vented discs, ABS
Wheels	Front: 8J x 18 ET 59 Rear: 9J x 18 ET 53	8J x 18 ET 59 9J x 18 ET 53
Tires	Front: 245/50 ZR 18 Rear: 275/45 ZR 18	245/50 ZR 18 275/45 ZR 18

Engine	Panamera Turbo	Panamera Turbo S
Cylinders	8	8
Displacement	4.8 liters	4.8 liters
Max. power at rpm	500 hp @ 6000 rpm	550 hp @ 6000 rpm
Max. torque at rpm	516 lb.-ft. @ 2250–4500 rpm	553 lb.-ft. @ 2250–4500 rpm
Compression ratio	10.5:1	10.5:1
Transmission		
Layout	Active all-wheel drive	Active all-wheel drive
PDK (7-speed)	Standard	Standard
Chassis		
Front axle	Fully independent large-format double-wishbone suspension	Fully independent large-format double-wishbone suspension
Rear axle	Fully independent multi-link suspension	Fully independent multi-link suspension
Steering	Power-assist (hydraulic)	Power-assist (hydraulic)
Brakes	Six-piston, aluminum monobloc fixed brake calipers at front, four-piston, aluminum monobloc brakes at rear, internally vented discs, ABS	Six-piston, aluminum monobloc fixed brake calipers at front, four-piston, aluminum monobloc brakes at rear, internally vented discs, ABS
Wheels	Front: 9J x 19 ET 60 Rear: 10J x 19 ET 61	9.5J x 20 ET 65 11J x 20 ET 68
Tires	Front: 255/45 ZR 19 Rear: 285/40 ZR 19	255/40 ZR 20 295/35 ZR 20

	Panamera	Panamera 4
Weight		
Curb weight	3,880 lbs	4,012 lbs
Max. load	1,334 lbs	1,278 lbs
Performance		
Top track speed*	160 mph	159 mph
0–60 mph	6.0 secs	5.8 secs
0–60 mph with Sport Chrono Package Plus	5.8 secs	5.6 secs
0–60 mph with Sport Chrono Package Turbo	–	–
0–100 mph	15.0 secs	15.2 secs
0–100 mph with Sport Chrono Package Plus	14.8 secs	15.0 secs
0–100 mph with Sport Chrono Package Turbo	–	–
Estimated EPA fuel economy		
City mpg	18	18
Highway mpg	27	26
Dimensions		
Length	195.6 in.	195.6 in.
Width (including exterior mirrors)	76.0 in. (83.2 in.)	76.0 in. (83.2 in.)
Height	55.8 in.	55.8 in.
Wheelbase	114.9 in.	114.9 in.
Luggage compartment volume	15.7 cu. ft.	15.7 cu. ft.
with rear seats folded down	44.6 cu. ft.	44.6 cu. ft.
Tank capacity (refill volume)	21.2 gal.	21.2 gal.

*Top track speed is achieved when vehicle is equipped with optional summer tires with adequate speed rating.

	Panamera S
Weight	
Curb weight	3,968 lbs
Max. load	1,334 lbs
Performance	
Top track speed*	175 mph
0–60 mph	5.2 secs
0–60 mph with Sport Chrono Package Plus	5.0 secs
0–60 mph with Sport Chrono Package Turbo	–
0–100 mph	11.7 secs
0–100 mph with Sport Chrono Package Plus	11.5 secs
0–100 mph with Sport Chrono Package Turbo	–
Estimated EPA fuel economy	
City mpg	16
Highway mpg	24
Dimensions	
Length	195.6 in.
Width (with exterior mirrors)	76.0 in. (83.2 in.)
Height	55.8 in.
Wheelbase	114.9 in.
Luggage compartment volume	15.7 cu. ft.
with rear seats folded down	44.6 cu. ft.
Tank capacity (refill volume)	21.2 gal.

*Top track speed is achieved when vehicle is equipped with optional summer tires with adequate speed rating.

	Panamera 4S	Panamera S Hybrid
Weight		
Curb weight	4,101 lbs	4,365 lbs
Max. load	1,278 lbs	1,113 lbs
Performance		
Top track speed*	175 mph	167 mph
0–60 mph	4.8 secs	5.7 secs
0–60 mph with Sport Chrono Package Plus	4.6 secs	5.5 secs
0–60 mph with Sport Chrono Package Turbo	–	–
0–100 mph	11.5 secs	16.9 secs
0–100 mph with Sport Chrono Package Plus	11.3 secs	14.5 secs
0–100 mph with Sport Chrono Package Turbo	–	–
Estimated EPA fuel economy		
City mpg	16	TBD**
Highway mpg	24	TBD**
Dimensions		
Length	195.6 in.	195.6 in.
Width (with exterior mirrors)	76.0 in. (83.2 in.)	76.0 in. (83.2 in.)
Height	55.8 in.	55.8 in.
Wheelbase	114.9 in.	114.9 in.
Luggage compartment volume	15.7 cu. ft.	11.8 cu. ft.
with rear seats folded down	44.6 cu. ft.	40.7 cu. ft.
Tank capacity (refill volume)	26.4 gal.	21.2 gal.

*Top track speed is achieved when vehicle is equipped with optional summer tires with adequate speed rating.
 **2012 EPA fuel economy estimates not available at time of printing. Please see your Authorized Porsche dealer for updates, or visit porsche.com.

	Panamera Turbo	Panamera Turbo S
Weight		
Curb weight	4,343 lbs	4,398 lbs
Max. load	1,169 lbs	1,169 lbs
Performance		
Top track speed*	188 mph	190 mph
0–60 mph	4.0 secs	–
0–60 mph with Sport Chrono Package Plus	3.8 secs	–
0–60 mph with Sport Chrono Package Turbo	3.6 secs	3.6 secs
0–100 mph	9.0 secs	–
0–100 mph with Sport Chrono Package Plus	–	–
0–100 mph with Sport Chrono Package Turbo	8.8 secs	8.3 secs
Estimated EPA fuel economy		
City mpg	15	15
Highway mpg	23	23
Dimensions		
Length	195.6 in.	195.6 in.
Width (with exterior mirrors)	76.0 in. (83.2 in.)	76.0 in. (83.2 in.)
Height	55.8 in.	55.8 in.
Wheelbase	114.9 in.	114.9 in.
Luggage compartment volume	15.2 cu. ft.	15.2 cu. ft.
with rear seats folded down	44.1 cu. ft.	44.1 cu. ft.
Tank capacity (refill volume)	26.4 gal.	26.4 gal.

*Top track speed is achieved when vehicle is equipped with optional summer tires with adequate speed rating.

Term	Page																
A																	
Adaptive air suspension	60	Direct Fuel Injection (DFI)	44	Instruments	91	Parallel full hybrid	25, 39	Rain sensor	106	Technical data	143						
Adaptive cruise control	109			Interior	13, 87, 125–134	ParkAssist	107	Rear lid	116	Thermally insulated glass	106						
Airbags	78	E															
All-wheel drive	53	Electric motor	39	Interior lighting	89	Parking brake, electric	75	Recuperation	42	Tiptronic S	49						
Anti-theft protection	110	Emissions control	80	Interior packages	125–134	Performance enhancement systems	65	Recycling	81	Tire Pressure Monitoring System (TPMS)	58						
Audio systems	95, 135	Engines	33, 121	L													
Auto Start Stop function	43	Environment	79	Lane Change Assist (LCA)	108	Personalization	118	Reversing camera	108	Touchscreen	96						
Axle concept	57	“E-power” button	40	Launch Control	48, 52, 67	Porsche Active Suspension Management (PASM)	59	Roof Transport System	116	Transmission	47, 121						
B																	
Battery management	39	“E-power” meter	42	Leveling system	60	Porsche Ceramic Composite Brakes (PCCB)	75	S									
Body engineering	77	Exhaust system	46	Light-alloy construction	77, 81	Porsche Communication Management (PCM)	96	Safety	71	Universal audio interface	98						
Bose® Surround Sound system	101	Exterior	11, 120	Lighting concept	71	Porsche Doppelkupplung (PDK)	47	Seat-belt system	78	Seats	91						
Brakes	75	F															
Burmester® High-End Surround Sound System	103	Fuel system	83	Lights	69	Porsche Dynamic Chassis Control (PDCC)	61	Service	139	V6 engine	35						
C																	
CD/DVD changer	96, 100	Headlight-cleaning system	71	Loading options	111	Porsche Dynamic Light System (PDLS)	74	Servicing	84	V8 engine	36						
Ceramic brake	75	Headlights	71	Luggage compartment	111	Porsche Entry & Drive Entertainment	100	Servotronic	57	Variable camshaft control	45						
Chassis	55, 121	Height adjustment	60	M													
Child seats	93	High-voltage nickel-metal hydride (NiMH) battery	39	MP3	96, 98, 100–101	Porsche Rear Seat Entertainment	100	Slide/tilt moonroof	109–110, 119	VarioCam Plus	45						
Climate control	105	HomeLink®	107	Multifunction steering wheel	51, 87	Porsche Side Impact Protection (POSIP) system	78	Sport button	43, 65	Voice-control system	98						
Coasting	41	H															
Colors	117					Porsche Stability Management (PSM)	63	Sport Chrono Package	65	W							
Communication	97, 99, 135					Porsche Torque Vectoring Plus (PTV Plus)	61	SportDesign steering wheel	52	Water-repellent side windows	106						
Cruise control	109					Porsche Traction Management (PTM)	53	Sport exhaust system	46, 122	Wheels	58, 123						
D																	
						Power liftgate	116	Sport steering wheel	51								
						Power output	35–38	Steering	57								
						Privacy glazing	90	Suspension	57								

**Standard interior colors.
Leather/soft-touch paint.**



Black



Platinum Grey



Luxor Beige

Carpet.



Black



Platinum Grey



Luxor Beige

Roof liner.

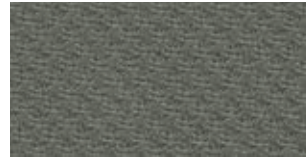

Platinum Grey*

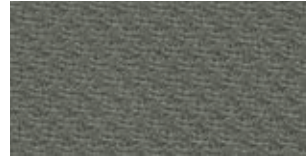

Platinum Grey

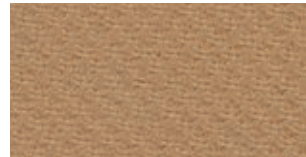

Luxor Beige

**Standard interior colors: Panamera Turbo S.
Leather/soft-touch paint.**



Black and Cream



Agate Grey and Cream

Carpet.



Cream**



Cream**

Roof liner.

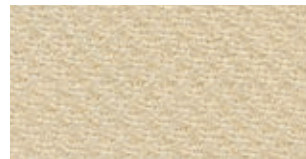

Cream

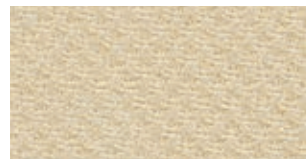

Cream

**Standard interior colors: leather interior.
Leather/soft-touch paint.**

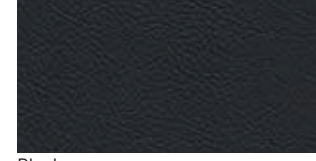

Black

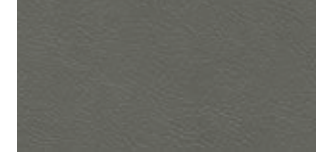

Platinum Grey

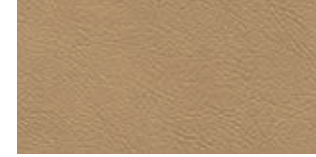

Luxor Beige



Yachting Blue



Marsala Red

Carpet.



Black

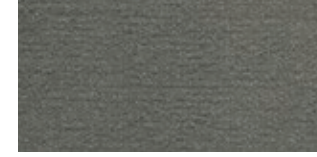

Platinum Grey



Luxor Beige



Yachting Blue



Marsala Red

Roof liner.

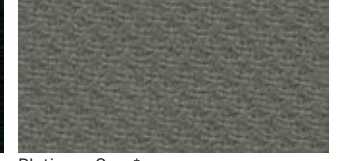

Platinum Grey*



Platinum Grey



Luxor Beige



Platinum Grey

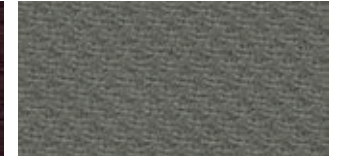

Platinum Grey

*In black when selected in conjunction with roof liner in Alcantara® (standard in the Panamera Turbo models).
**With two-tone combinations, the luggage compartment is always in the darker of the two colors.

Two-tone combinations: leather interior.

Leather/soft-touch paint.

Carpet.

Roof liner.

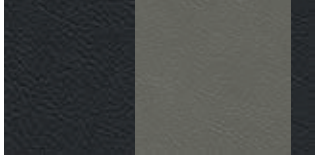

Black and Platinum Grey

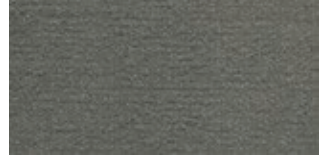

Platinum Grey**



Platinum Grey*



Luxor Beige and Cream



Cream**



Cream



Yachting Blue and Cream



Cream**



Cream



Marsala Red and Cream



Cream**

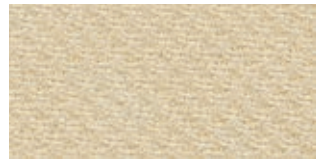

Cream

Natural leather interior.

Leather/soft-touch paint.

Carpet.

Roof liner.

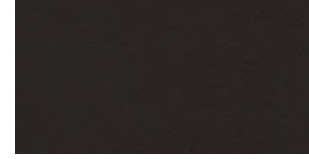

Espresso natural leather

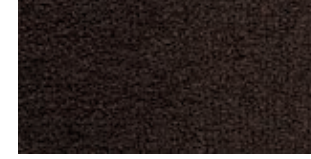

Espresso



Platinum Grey



Cognac natural leather



Cognac

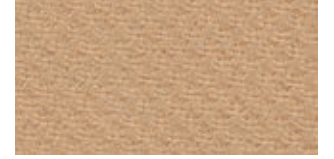

Cedar

Two-tone combination: natural leather interior.

Leather/soft-touch paint.

Carpet.

Roof liner.



Cognac and Cedar natural leather



Cedar



Cedar

*In black when selected in conjunction with roof liner in Alcantara® (standard in the Panamera Turbo models).
 **With two-tone combinations, the luggage compartment is always in the darker of the two colors.

Interior packages.

Wood, Carbon Fiber, Aluminum.



Walnut (standard on the Panamera Turbo)*,**



Tineo*,**



Anthracite Birch (standard on the Panamera Turbo S)*,**



Natural Olive**



Yachting Mahogany*,**



Brushed Aluminum

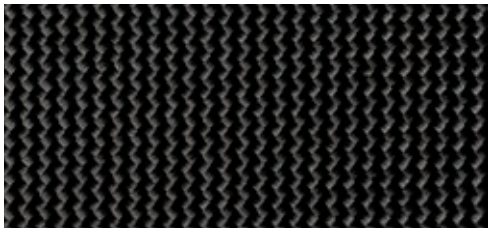

Carbon Fiber*

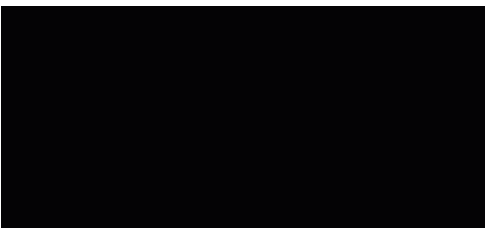

High-gloss black (standard)

*Also available on steering wheel.

**Since wood is a natural product, there may be variations in color and grain.

Solid exterior colors.

Metallic exterior colors.

Special exterior colors.

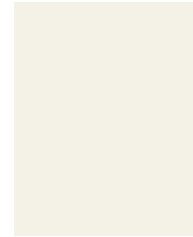

Carrara White



Basalt Black Metallic

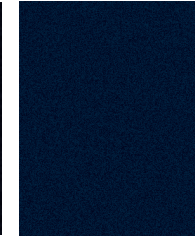

Dark Blue Metallic



GT Silver Metallic

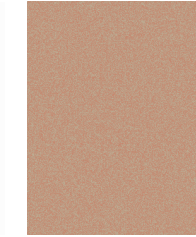

Luxor Beige Metallic



Black



Platinum Silver Metallic

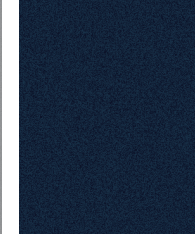

Yachting Blue Metallic



Crystal Green Metallic

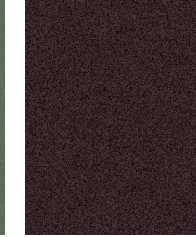

Mahogany Metallic



Carbon Grey Metallic



Agate Grey Metallic



Amethyst Metallic



Cognac Metallic



Ruby Red Metallic



Topaz Brown Metallic

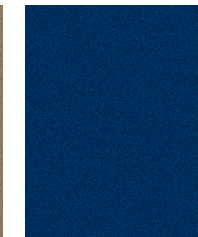

Aqua Blue Metallic