



PORSCHE



# The Panamera model range



<b>Concept</b>	<b>6</b>
The Panamera model range	8
Panamera and Panamera 4	32
Panamera S and Panamera 4S	36
Panamera Turbo	38
<b>Performance</b>	<b>40</b>
Engines	42
Transmission	54
Chassis	62
<b>Balance</b>	<b>78</b>
Safety	80
Environment	92
<b>Personality</b>	<b>98</b>
Comfort	100
Colours	132
Personalisation	141
<b>Factory collection</b>	<b>161</b>
<b>Service</b>	<b>162</b>
<b>Summary</b>	<b>164</b>
<b>Technical data</b>	<b>166</b>
<b>Index</b>	<b>170</b>

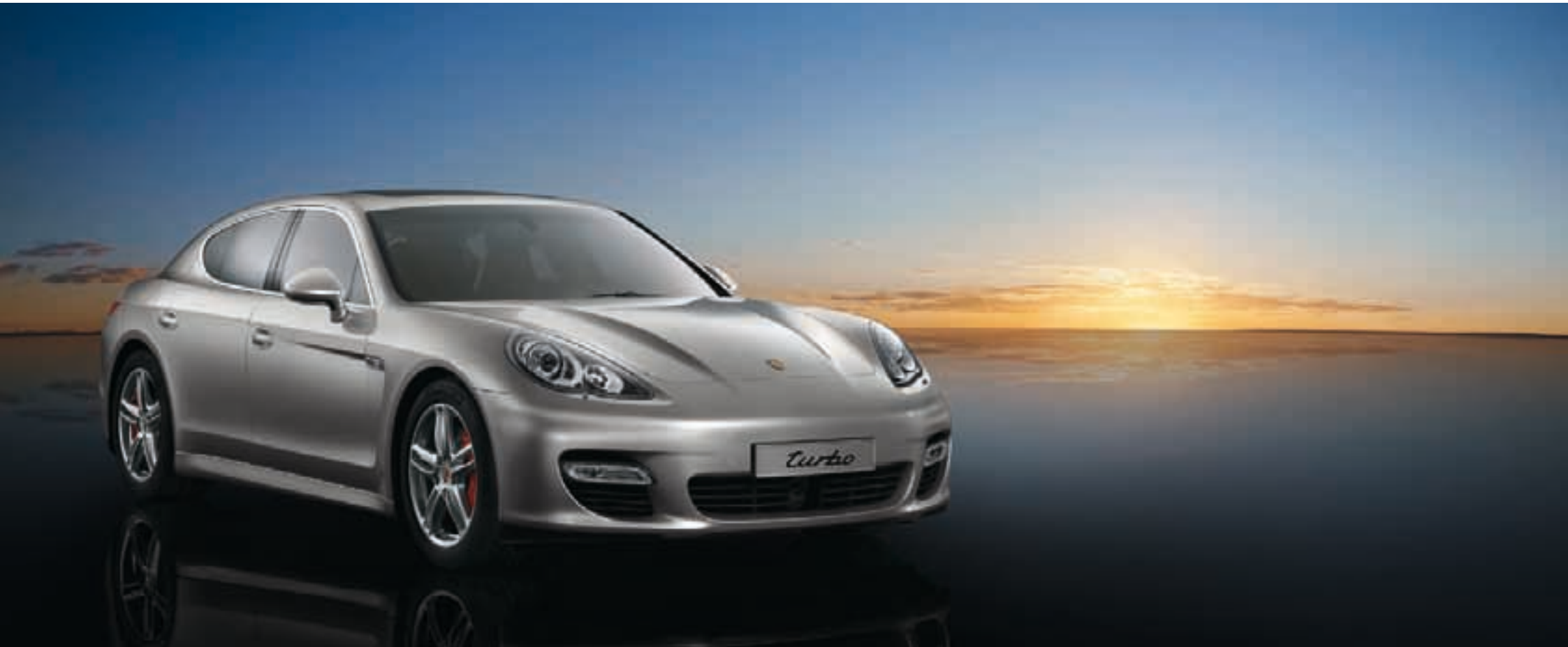

## Concept

The Panamera models. Four doors. Four seats. Sportscar technology for four. Comfort and everyday practicality without compromise. Efficient drive concepts, a lightweight body and highly dynamic. This is the principle of Porsche Intelligent Performance.

**We have absolutely no experience when it comes to building large, heavy saloons. How fortunate.**

### The Panamera model range.

What can a car manufacturer with such a small market share worldwide have to say about luxury saloons? Good question.

It's true that life sometimes has to be taken very seriously, but not necessarily everywhere and all of the time. It's good to lighten up and relax a little. Look at things in an original way. Think differently.

Not everyone who achieves success should feel bound by convention. A few reject the norms and constraints of society and view things from a new perspective: open, surprising, agile and inquisitive.

Luxury needn't mean cumbersome – it can mean dynamic instead. This is our definition of luxury. Let's call it 'dynamic luxury' – because sportiness is more important to us than anything else. It's about a car that you would want to drive, as well as be driven in. That's why we've developed the Panamera model range. It's that simple. And that's actually nothing new for Porsche.

It's not about coupés, nor is it even about saloons. After all, in the sporty luxury saloon and coupé segments, driving, as we understand it, now seems to mean something else.

Perhaps it's a slight exaggeration, but let's simply call it functional mobility. Getting from A to B, where A and B seem to be more important than the road in between. Some believe that the sound of the road is nothing to savour and that soft seats are as essential as ride comfort.





It's an attitude that we don't understand. Nor would we want to. It's our firm belief that the road has its own tales to tell – tales of twisting bends, of weather, and of a passion for driving.

For us (and you?), it's not just about mobility. It's about journeys that are an experience in themselves. It's about time to oneself. It's about ease of performance and a relationship with the road.

We believe it's about the pure driving experience. And it has to be so, regardless of whether you sit in the front or the back. It's about four doors and four seats in a Porsche. Sportscar technology for four.

The new Panamera.  
The new Panamera 4.  
The Panamera S.  
The Panamera 4S.  
The Panamera Turbo.  
  
Zero compromise.

**A breath of fresh air in the premium class: sportscar technology.**

**Engineering.**

Just a second, you may be thinking, sports saloons already exist. Exactly what is so new about all this? What is required when sporty luxury alone is not enough? Well, how about a Porsche with four doors and four seats in the premium class – a Gran Turismo with sportscar technology.

The new 3.6-litre V6 engine is naturally aspirated and produces 300 hp. The 4.8-litre V8 engines, either naturally aspirated or twin-turbocharged, generate 400 hp and 500 hp respectively. All engines feature VarioCam Plus (p. 52) and direct fuel injection (DFI, p. 51) for efficient combustion, a distinct rise in power and torque, and comparatively low fuel consumption for this class of engine.

Fuel economy is also boosted by an Auto start/stop function, only in conjunction with Porsche Doppelkupplung (PDK). If, for example, you stop at traffic lights with your foot on the brake pedal, the system will automatically stop the engine. The engine restarts as soon as you release the brakes or move the steering wheel, for example.

An optional sports exhaust system is available for the Panamera S models and the Panamera Turbo. Activated by a separate button, it produces an even more authentic sportscar sound.

As you would expect from a sportscar, power is transmitted quickly and precisely. In the new Panamera and the Panamera S, power is delivered to the rear axle

by a 6-speed manual transmission. In the new Panamera 4, the Panamera 4S and the Panamera Turbo, all of which feature the 7-speed Porsche Doppelkupplung (PDK, p. 55) as standard, drive force is distributed between the front and rear axles by the active all-wheel drive of Porsche Traction Management (PTM, p. 60) with an electronic and map-controlled multiplate clutch for optimum traction and driving stability.

PDK is based on a development that helped Porsche racing cars in the 1980s to cause a sensation on racetracks around the world. Gear changes take place within hundredths of a second and with no interruption in the flow of power – for sporty acceleration with a high level of comfort and a low rate of fuel consumption.



Gear selector for the 7-speed Porsche Doppelkupplung (PDK)

Also new to the premium class are the optional Sport Chrono Packages (p. 74). These further enhance the driving dynamics of the Panamera models at the push of a button. Two special functions

are available in conjunction with PDK: Launch Control for optimum acceleration from a standing start and, in the Panamera Turbo, the 'overboost' function. This feature increases boost pressure

temporarily and consequently the engine's maximum torque: instead of 700 Nm, a torque figure of up to 770 Nm is achieved.



SPORT PLUS button from the optional Sport Chrono packages

Porsche Active Suspension Management (PASM, p. 66) comes as standard on the Panamera S, 4S and Turbo, and is available as an option for the new Panamera and Panamera 4 models. This system actively and continuously regulates the damping force for each wheel according to the road conditions and driving style. Any one of three suspension settings can be selected. The Panamera Turbo additionally features adaptive air suspension (p. 68) as standard, for increased comfort

or a sportier ride – in simple terms, it's a sports chassis at the push of a button.

Available as an option for all Panamera models is Porsche Dynamic Chassis Control (PDCC) with Porsche Torque Vectoring Plus (PTV Plus). This active anti-roll system reduces the lateral tilt of the vehicle when cornering and thereby improves agility and safety. Combined with PDCC, PTV Plus offers increased traction and driving dynamics (p. 70).

The Porsche Ceramic Composite Brake (PCCB, p. 86) can be fitted on request. On the Panamera, Panamera 4, Panamera S and Panamera 4S models, the grooved ceramic brake discs have a diameter of 390 mm at the front and 350 mm at the rear (only in conjunction with 19-inch wheels or larger). For more powerful braking, the discs on the Panamera Turbo are 410 mm at the front and 350 mm at the rear (only compatible with 20-inch wheels). This advanced braking system offers high-performance braking at all times.

All Panamera models are constructed using lightweight hybrid materials. The axles, bonnet, front wings, doors and rear lid, for example, are made from aluminium and the window frames and cylinder head cover are made from magnesium, all of which reduces weight and therefore fuel consumption.

A steering system with variable steering ratio is fitted as standard. Servotronic (p. 64), a speed-sensitive power-steering system, is available as an option.

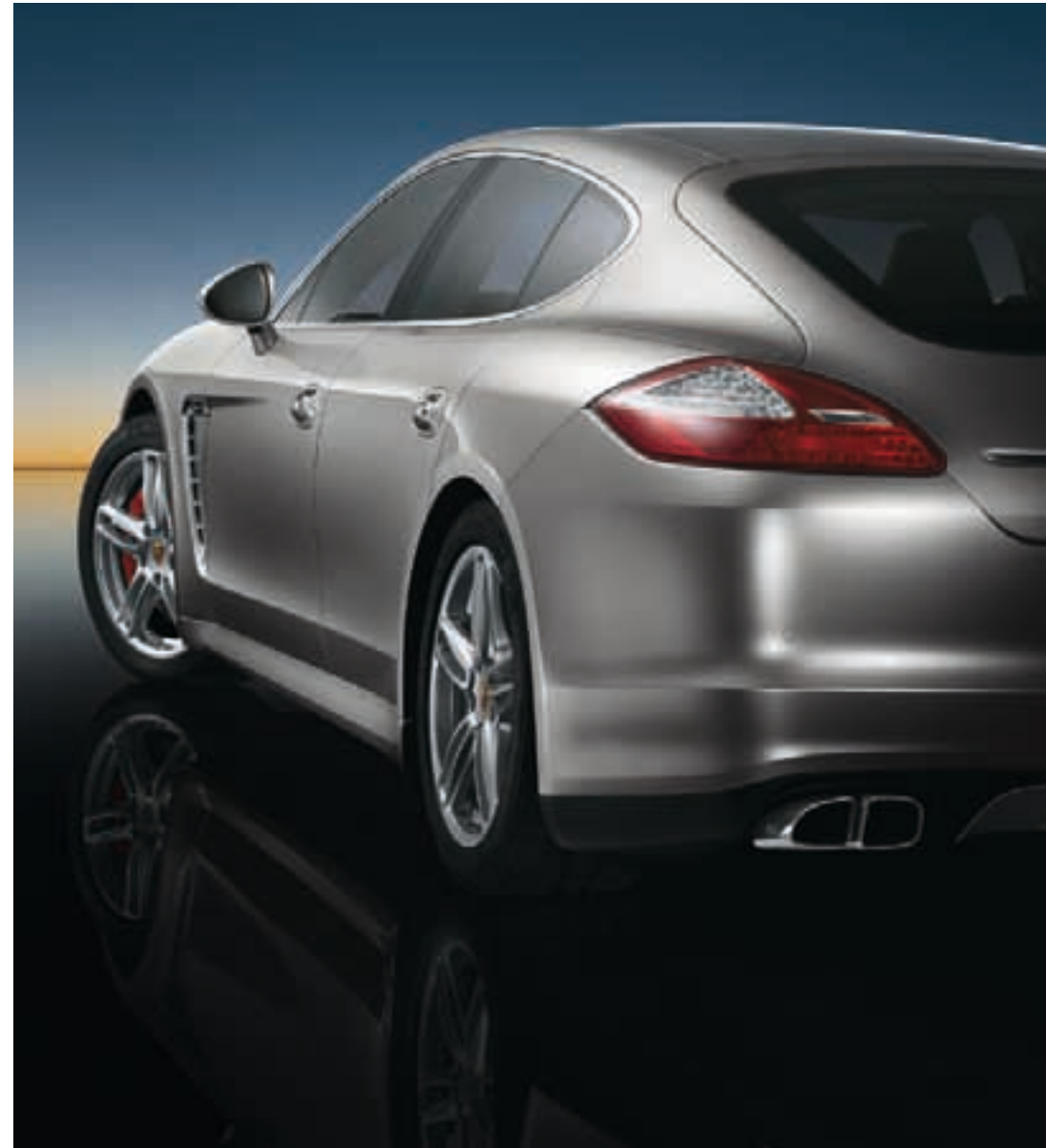



Porsche Communication Management (PCM) with navigation module

Cruise control comes as standard in all models, while adaptive cruise control is available as an option (p. 122). In order to maintain a safe distance from the vehicle in front, adaptive cruise control regulates the speed of your vehicle in line with the distance between your vehicle and the vehicle ahead, even down to a complete stop, thereby relieving the strain on the driver during long journeys.

Cutting edge technology is also featured in the Porsche Communication Management System (PCM,

p. 108), which is fitted as standard on all models. It includes a navigation module with high-speed hard drive, high-resolution 7-inch touchscreen, optional voice control system with word-by-word input, and a CD/DVD-audio drive.

The sound of a Porsche is unique. The audio systems must therefore meet the highest standards. The optional BOSE® Surround Sound System (standard in the Panamera Turbo, p. 114) offers excellent sound quality. Available as an option for all models is the

High-End Surround Sound System from Burmester® (p. 116), one of the most respected premium audio manufacturers worldwide.

Comfort and sportscar technology side by side. Surprising for many, perhaps. For you, it's simply Porsche.



Adaptive cruise control



**If you loved the road,  
you wouldn't dream of tarnishing it.**

**Exterior design.**

As you can see, we didn't experiment with the car's design. We stuck with our philosophy that form should follow function. Nothing else would have made sense. Nothing else would have produced a four-seater Porsche.

But how can you tell whether it has the Porsche DNA? From the

distinctive proportions and lines on all models. The wings are slightly higher than the bonnet and, at the rear, they are distinctly muscular and form the typical Porsche shoulder line. The silhouette of the Panamera models is therefore typically Porsche. It is dynamic without being overbearing, and exudes elegance rather

than extravagance. In its class, the total length of less than five metres is to its advantage. The front, shoulders, and rear all have instantly recognisable Porsche traits. Particularly striking are the side air outlets behind the front wheels – paying homage to the Carrera GT. The result is a timeless exterior, a spacious interior and excellent aerodynamics: the Panamera S models have a drag coefficient of 0.29, the Panamera models and the Panamera Turbo 0.30.

A low, wide stance. A sleek roofline. The overall impression leaves you in no doubt that these are true sportscar proportions. Typically Porsche. And yet, when you get in, you'll wonder how there can possibly be so much room. We'll come to that on the pages that follow.

Unmistakably Porsche and yet characteristically Panamera is the headlight design (p. 80). The headlights on the Panamera Turbo are supplemented by the Porsche Dynamic Light System (PDLS) (p. 83).

Position lights and daytime running lights with LED technology on all Panamera models add a special touch.

The wheels are of classic sportscar design: fine-spoked, lightweight, and stylish. Sizes range from 18 inches to an optional 20 inches, and all the wheels provide a good glimpse of the brake system. Just another example of sporty styling.



The rear lid with large glass screen opens to a wide angle. This makes loading easier and improves access to luggage when the vehicle is laden. An automatic rear lid with customisable opening angle is available as an option (p. 131).

The most striking aspect of the rear is undoubtedly the spoiler which is integrated into the rear lid. From a speed of around 55 mph (90 km/h), it deploys automatically, as you may already have suspected. However, on the Panamera Turbo, it doesn't stop there. The spoiler splits in the middle and extensions deploy to the left and right, making it considerably wider to further reduce lift at the rear axle. And from 127 mph (205 km/h), the spoiler on all models adjusts to increase its steepness to produce even more traction and, as a result, increased driving stability at high speeds.

The appearance of any Panamera model can be customised to your individual taste. The colour palette offers no fewer than 17 exterior colours. In total, there are two solid, ten metallic and five special colours to choose from. On request, you can opt to have your Panamera model finished in practically any colour of your choice. In addition, a wide range of personalisation options is available. For more information, please refer to page 132 onwards.

So you see, whichever way you look at it, it looks like a Porsche. And, most importantly, it feels like one too.



## **We've been playing with the concept of a saloon. It lost 4:0.**

### **Interior design.**

Whatever kind of journey you are making – short or long, for business or pleasure, or even just routine driving – the Panamera offers something a little bit different.

When you sit inside one of the Panamera models, four things immediately stand out: first, the elevated centre console; second, the four individual seats; third, the amount of space in the rear

where even taller passengers will find plenty of leg and head room; and fourth, the versatility of the luggage compartment thanks to the folding rear seats.

The ignition lock is, of course, located on the left-hand side of the steering wheel, as in all Porsche vehicles. The instrument cluster incorporating the central rev counter is clear and quick to read.

The four individual seats (p. 104) are comfortable and offer good lateral support. In conjunction with seat heating, a seat ventilation function is also available as an option. The electrically adjustable 8-way power seats in the rear (p. 106) are another special feature available on request.

Why four individual seats? Because only these satisfy our requirement for high-performance driving and a high level of seating comfort. Conventional rear bench seats can not fulfil this requirement and instead made way for a centre console.







If you regularly spend time in the rear, you can customise it with a range of optional equipment and packages, such as the large centre console, the roll-up sunblinds for the rear side windows and behind the rear compartment, or the rear interior lighting package.

The preserve of the premium class: the comprehensive range of personalisation options,

with seven interior colours and five two-tone combinations and a range of optional packages featuring fine woods, carbon or aluminium.

If you suspected that the Panamera is more than just a sports car with four seats, this is confirmed by a glance inside the luggage compartment (p. 126). Under the large rear lid, there is space to accommodate four

suitcases from the Porsche Design Driver's Selection. Enough room, then, for a journey with four occupants. Practicality, but the Porsche way.

For more information on our many combinations of technological options, colours and materials for the interior, please see page 132 onwards.

**Does your head tell you that pleasure and efficiency are mutually exclusive? Listen to your heart instead.**

**The new Panamera and the new Panamera 4.**

So, you have duties to perform, but who says that you cannot follow your heart and combine practicality with pleasure at the same time? No, for us, there is no conflict here, but a principle: efficiency. It's not about maxi-

mum engine power, but intelligent overall performance. That makes practical sense, and pleasure, too.

The distinguishing features of the Panamera and Panamera 4 are the 18-inch Panamera wheels,

black brake calipers and twin single-tube tailpipes. The side windows have matt black borders.

Characteristic of the new Panamera are the black double slats on the side air intakes in



Panamera



Panamera 4

the front apron and a rear apron diffuser with black-grained finish. The new Panamera 4 is identifiable by the titanium-coloured double slats and a rear apron diffuser with fins.

In terms of performance, the Panamera and Panamera 4 are equipped with the new 3.6-litre naturally aspirated V6 engine. Efficient and sporty, thanks to

direct fuel injection (DFI, p. 51) and VarioCam Plus (p. 52) fitted as standard, it generates 220 kW (300 hp) and 400 Nm of torque.

On the new Panamera, power is transmitted to the rear axle by a 6-speed manual gearbox. The 7-speed Porsche Doppelkupplung (PDK, p. 55) with Auto start/stop function (p. 50) is available as an option. This double-clutch

transmission enables fast gear changes with no interruption in the flow of power, for increased performance and greater comfort but low fuel consumption.



Panamera 4 with 19-inch Panamera Design wheels, Panamera with 20-inch 911 Turbo II wheels

On the new Panamera 4, drive force is transmitted to the road by the active all-wheel drive of Porsche Traction Management (PTM, p. 60) and by the 7-speed Porsche Doppelkupplung (PDK) with Auto start/stop function, both of which are fitted as standard.

The steel spring suspension is standard on both models, offering a high level of comfort despite its sporty setup. Porsche Active Suspension Management (PASM,

p. 66) or adaptive air suspension with PASM are available on request.

Also standard is Porsche Stability Management (PSM, p. 72), which maintains stability even at the limits of dynamic driving performance, delivering better traction and increased safety.

And yet the gross weight of these models is as low as 1,730 kg. Driving pleasure is simply inevitable.

The figures speak for themselves: the new Panamera accelerates from 0 to 62 mph (100 km/h) in 6.8 seconds, with a top speed of 162 mph (261 km/h). With the optional Porsche Doppelkupplung (PDK), these figures are an even more impressive 6.3 seconds and 161 mph (259 km/h). The Panamera 4 completes the 0 to 62 mph (100 km/h) sprint in just 6.1 seconds and has a top speed of 159 mph (257 km/h).

Both models are equipped with Bi-Xenon headlights as standard.

The interior offers plenty of comfort and lots of space. The two individual seats in the rear compartment fold separately or jointly, increasing luggage capacity to 1,263 litres. Automatic climate control is standard. Three interior colours are available for the partial leather interior. The seat surfaces, inner backrest surfaces and side bolsters,

door handles, door armrests and armrest section of the centre console are finished in embossed leather, while the gear lever or selector and steering wheel rim are in smooth-finish leather.

The three-spoke sports steering wheel, black dial faces and interior trims in high-gloss black add to the interior's visual appeal.

Porsche Communication Management (PCM, p. 108) with navigation module is fitted as standard. The BOSE® Surround Sound

System (p. 114) or the Burmester® High-End Surround Sound System (p. 116) are available as options.

The new Panamera and Panamera 4 models offer the best of both worlds: performance and practicality. They are comfortable, luxurious, fit for long journeys, and every bit a Porsche.



Interior of the Panamera in Luxor Beige

**Four doors.  
But a classic sports car nonetheless.**

**The Panamera S and the Panamera 4S.**

You could choose to drive a sporty saloon. Or a sporty MPV. Alternatively, you could choose to drive a four-seater Porsche. Just like the Panamera S or Panamera 4S, with performance figures to match many a sporty two-seater.

The S models are recognisable by the silver-coloured brake calipers behind the 18-inch Panamera S wheels and by their round twin

tailpipes. The side windows have a chrome-coloured border. In the interior, the silver-coloured rev counter dial is visually striking.

On the Panamera S, the double slats on the side air intakes are black. On the Panamera 4S, they are titanium-coloured.

Both models have a 4.8-litre naturally aspirated V8 engine

that produces 294 kW (400 hp) and 500 Nm of torque. On the Panamera S, power is transmitted to the rear wheels by the standard 6-speed manual gearbox. The 7-speed Porsche Doppelkupplung (PDK) is available as an option. On the Panamera 4S, PDK is standard and transmits drive force to the all-wheel drive of Porsche Traction Management (PTM, p. 60) – also fitted as standard.

The Panamera S accelerates from 0 to 62 mph (100 km/h) in just 5.6 seconds, with a top speed of 177 mph (285 km/h). With the optional PDK, figures of 5.4 seconds and 176 mph (283 km/h) are achieved. The Panamera 4S completes the sprint in only 5.0 seconds and has a top speed of 175 mph (282 km/h).

Steel spring suspension with Porsche Active Suspension Management (PASM, p. 66) is fitted as standard in both models. Adaptive air suspension, 20-inch wheels and a sports exhaust system are just three of many options you can select to personalise your vehicle.

Safety features include Bi-Xenon headlights with dynamic range adjustment (p. 80), which provide more effective illumination of the road and are fitted as standard on both models. Also standard is Tyre Pressure Monitoring (TPM, p. 65) and the automatically dimming mirrors.

A high level of interior comfort is assured by the automatic climate



Panamera 4S with sports exhaust system and 20-inch RS Spyder Design wheels

control system and the heated seats fitted as standard in the front, with seat heating optional for the rear. Seat ventilation is available on request. The partial leather interior has the same specification as for the Panamera/Panamera 4.

Porsche Communication Management (PCM) with navigation module is standard on both the

Panamera S and Panamera 4S. The BOSE® Surround Sound System (p. 114) or Burmester® High-End Surround Sound System (p. 116) are both optional.

These options are only the beginning when it comes to customising the Panamera S or 4S. Give your four-seater Porsche your very own personal touch.



Panamera S

**Meet the pinnacle of the Panamera range.**

**The Panamera Turbo.**

Four doors. Four seats. Eight cylinders. Up to this point, others may even have been able to keep up. But then comes a point of difference in the form of the Panamera Turbo. It not only joins a long line of Porsche Turbo models, it leads the way with its extensive standard equipment

combined with a host of features that are exclusive to a Turbo.

What about the aesthetics? 19-inch Panamera Turbo wheels and red brake calipers, naturally. Twin dual-tube tailpipes in the unmistakable Turbo design. Four LED daytime running lights in

each headlight unit with separate direction indicators. The front apron features horizontal slats and longitudinal struts in the air intakes. The air outlets in the wing behind the front wheels also have slats. Five, to be exact, and all in a chrome finish. The

auto-deploying two-piece rear spoiler is typically characteristic.

The Panamera Turbo is powered by a 4.8-litre V8 twin-turbo engine that generates an output of 368 kW (500 hp) and 700 Nm. The seven-speed Porsche Doppelkupplung (PDK, p. 55) is fitted as standard, as is Porsche Traction Management (PTM, p. 60) with active all-wheel drive and an electronic and map-controlled multi-plate clutch.

Performance is exemplary. The Panamera Turbo races from 0 to 62 mph (100 km/h) in just 4.2 seconds and has a top speed of 188 mph (303 km/h).

Also fitted as standard in the Panamera Turbo is adaptive air suspension including Porsche Active Suspension Management (PASM) with three damping, suspension and ride-height settings ranging from comfort to extra sporty (p. 66–69). Increased performance or greater comfort? The choice is yours. Simply press the button.

And what about the interior? Typically Porsche with all the usual Turbo features. A perfect combination of sportiness and comfort. As standard equipment, the interior features electrically adjustable 14-way power seats with memory package in the front (p. 104), with seat heating front and rear. Also standard are the smooth-finish leather and walnut interior packages. Alternatively, the anthracite birch, tinea or brushed aluminium interior packages are available at no extra cost.

Moreover, the Porsche Communication Management (PCM) with navigation module – standard on all models – has been combined with the BOSE® Surround Sound System (p. 114). The Burmester® High-End Surround Sound System (p. 116) is also available as an option.



Panamera Turbo



Interior of the Panamera Turbo in Espresso natural leather



## Performance

You know how it is, you always put in a good performance when you're under pressure. But you give your best performance when there is genuine enjoyment to be had. And nothing is more liberating than the feeling of having accomplished something others said would be impossible.



## So you want to satisfy your green credentials even in the red zone?

### Engines.

For saloon drivers, it seems, the interior is no place for engine noise. But how important is the engine to you? We thought so. Just as important as it is to us. This is why we – like you – are perfectly happy with that seductive sound. We – like you – want to hear that the Panamera models are unmistakably Porsche.

When it comes to the environment, the facts speak for themselves. Engines with high efficiency and low fuel consumption. High power output with comparatively low CO<sub>2</sub> emissions per hp.

Low on weight, too. The light-alloy engines have cast aluminium pistons (Panamera and Panamera S models) or forged pistons (Panamera Turbo), aluminium one-piece cylinder heads and an

aluminium crankcase of closed-deck construction. The casing and cooling ducts around the cylinders form a closed system. The engines are therefore lightweight for reduced fuel consumption and have a long service life.

The V6 engine, which is based on the V8 engine, additionally features a balance shaft to minimise vibrations and ensure smooth running.

An integrated dry-sump lubrication system guarantees a reliable supply of oil in all driving situations. Instead of an external oil tank, the oil reservoir is located directly inside the engine, which saves on space and weight.

### Electronic engine management system.

The electronic engine management system ensures optimum engine performance at all times. In par-

ticular, it evaluates the signals of the electronic accelerator pedal (E-Gas) – a prerequisite for Porsche Stability Management (PSM, p. 72), which is fitted as standard. Moreover, it regulates all engine-related functions and assemblies. The results: optimum performance and torque with reduced fuel consumption and emissions, whatever your driving style.

Another important function is the cylinder-specific knock control, which compensates for different fuel grades added to the engine. Since cylinders never all work under exactly the same conditions, the ignition point is shifted individually, as and when necessary.

The on-board diagnostics ensure timely detection of any faults and defects that may occur in the

exhaust and fuel systems and notify the driver immediately. This also prevents increased pollutant emissions and unnecessary fuel consumption.





V6 engine

**New V6 engine.**

The new Panamera and Panamera 4 models are equipped with an efficient and lightweight 3.6-litre naturally aspirated V6 engine based on the V8 power unit. A balance shaft reduces vibration to ensure very smooth operation. Direct fuel injection (DFI) and VarioCam Plus are featured as standard. The engine delivers 220 kW (300 hp) at 6,200 rpm. Maximum torque of 400 Nm is achieved at 3,750 rpm.

This impressive power output enables the rear-wheel-drive Panamera with manual gearbox to accelerate from 0 to 62 mph (100 km/h) in only 6.8 seconds, with a top speed of 162 mph (261 km/h). With the optional Porsche Doppelkupplung (PDK), these figures are an even more impressive 6.3 seconds and 161 mph (259 km/h). Thanks to PDK and the active all-wheel drive of Porsche Traction Management (PTM), the Panamera 4 completes the sprint in 6.1 seconds and has a top speed of 159 mph (257 km/h).

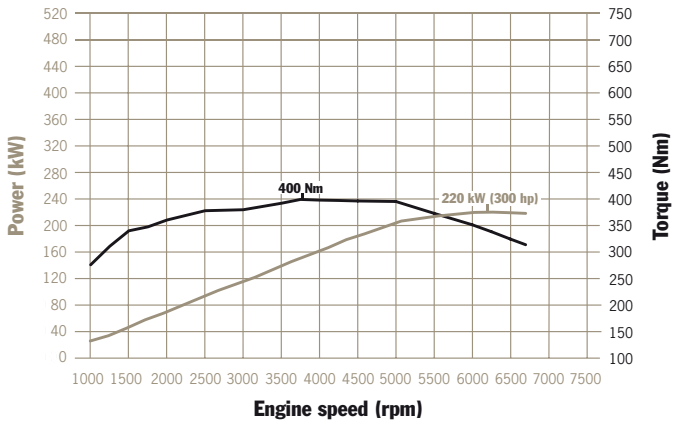

Panamera and Panamera 4: 220 kW (300 hp) at 6,200 rpm, 400 Nm at 3,750 rpm



- |   |                              |                                 |
|---|------------------------------|---------------------------------|
| 1. Throttle body/E-Gas                  | 9. Spark plug                | 17. Air-conditioning compressor |
| 2. Intake manifold                      | 10. Piston                   | 18. PDCC/power-steering pump    |
| 3. Intake manifold flap                 | 11. High-pressure pump       | 19. Poly-V belt                 |
| 4. Duplex chain                         | 12. High-pressure rail       |                                 |
| 5. VarioCam Plus (vane-cell controller) | 13. Injector                 |                                 |
| 6. Intake camshaft                      | 14. Exhaust manifold         |                                 |
| 7. Exhaust camshaft                     | 15. Water pump (behind)      |                                 |
| 8. Valve                                | 16. Oil-water heat exchanger |                                 |



**V8 engine.**

The Panamera S and the Panamera 4S both have a 4.8-litre naturally aspirated V8 engine with direct fuel injection (DFI), VarioCam Plus and a variable intake manifold. It generates 294 kW (400 hp) at 6,500 rpm and has a maximum torque of 500 Nm between 3,500 rpm and 5,000 rpm.

Delivering a top speed of 177 mph (285 km/h), the Panamera S with manual gearbox and rear-wheel drive accelerates from 0 to 62 mph (100 km/h) in 5.6 seconds. With the optional Porsche Doppelkupplung (PDK), the clock stops after just 5.4 seconds, and a top speed of 176 mph (283 km/h) is achieved. Thanks to PDK and the active all-wheel drive of Porsche Traction Management (PTM), the Panamera 4S completes the sprint in an even more impressive 5.0 seconds and has a top speed of 175 mph (282 km/h).



V8 engine

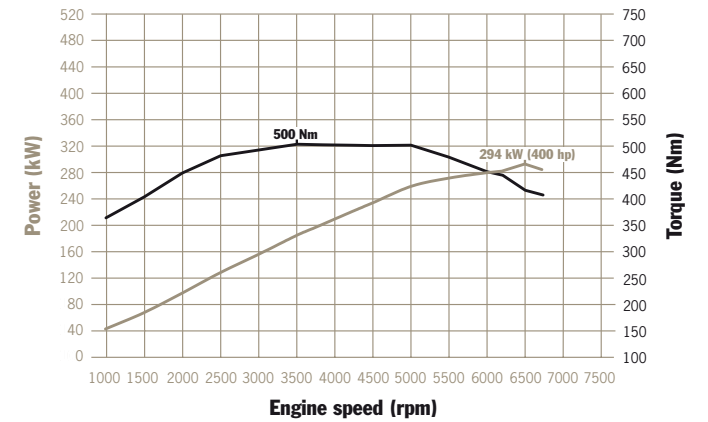

Panamera S and 4S: 294 kW (400 hp) at 6,500 rpm, 500 Nm between 3,500 and 5,000 rpm



V8 twin-turbo engine

**V8 twin-turbo engine.**

The Panamera Turbo is powered by a 4.8-litre V8 twin-turbo engine with direct fuel injection (DFI), VarioCam Plus and charge-air cooling. It generates 368 kW (500 hp) at 6,000 rpm and its maximum torque of 700 Nm is available between 2,250 and 4,500 rpm. With a top speed of 188 mph (303 km/h), it races from 0 to 62 mph (100 km/h) in 4.2 seconds. Using the Launch Control function of the Sport Chrono Package Turbo (p. 76), the clock stops even sooner at 4.0 seconds.

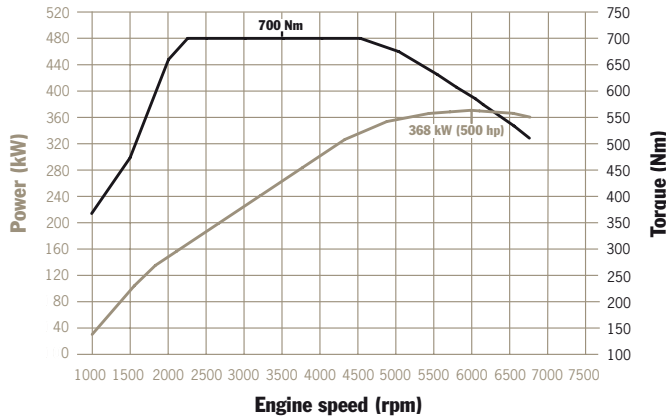

Panamera Turbo: 368 kW (500 hp) at 6,000 rpm, 700 Nm between 2,250 and 4,500 rpm



- |  |                         |                                 |
|--|-------------------------|---------------------------------|
| 1. Intake manifold   | 8. Intake camshaft      | 16. Oil-water heat exchanger    |
| 2. High-pressure pump  | 9. Exhaust camshaft     | 17. Air-conditioning compressor |
| 3. VarioCam Plus (vane-cell controller)  | 10. Valve               | 18. PDCC/power-steering pump    |
| 4. Duplex chain  | 11. Piston (underneath) | 19. Water pump (underneath)     |
| 5. High-pressure rail  | 12. Spark plug          | 20. Poly-V belt                 |
| 6. Injector (underneath)   | 13. Exhaust manifold    | 21. Throttle body/E-Gas         |
| 7. VarioCam Plus (switch tappets with integrated valve clearance compensation) | 14. Turbocharger        |                                 |
|  | 15. Oil filter          |                                 |

**SPORT button.**

All Panamera models are equipped with the SPORT button as standard. This feature enables the driver to vary the engine characteristics and, in vehicles with PASM, the suspension setup. In vehicles with Porsche Doppelkupplung (PDK), the SPORT button can be used to select a sportier gearshift strategy. For more information, please refer to page 74.

**Auto start/stop function (only in conjunction with Porsche Doppelkupplung, PDK).**

Silence: the typical stationary noise. If, for example, you stop at traffic lights with your foot on the brake pedal, the Auto start/stop function will automatically stop the engine. This fuel-saving system restarts the engine as soon as you release the brakes.

A key advantage is that there is no need for you to change your driving habits. You can simply carry on as normal. All audio and communication systems remain switched on and the climate

control continues to maintain your selected temperature, despite the engine being switched off. The engine restarts if more power or extra cooling output is required.

The Auto start/stop function can be activated and deactivated using a separate button. The function may remain inactive under particular circumstances, e.g. very high outside temperatures, on extreme uphill gradients, or if battery charge is low.

The starter has been modified to meet the increased requirements demanded by this function and

the battery is continuously monitored for the level of charge and condition. The battery and starter are consumable components and are subject to an increased rate of wear in the event of frequent engine stopping.

Fuel economy is further improved by electrical system recuperation, whereby the battery is charged predominantly under braking. Under acceleration, on the other hand, the alternator's charging current is reduced so that the engine does not need to work as hard to charge the battery.



**A sense of relaxation is felt especially after a period of intense pressure.**

**Direct fuel injection (DFI).**

With millisecond precision, DFI injects fuel at up to 120 bar directly into the combustion chamber by means of electromagnetically actuated injection valves.

The spray and cone angles have been optimised for torque, power output, fuel consumption and emissions by enabling a homogeneous distribution of the air/fuel mixture, and, therefore, effective

combustion. At up to 3,500 rpm, the engine operates with dual injection for faster heating of the catalytic converters after a cold start and for greater torque in the upper load range.

DFI improves the internal cooling of the combustion chamber by having the mixture prepared directly in the cylinder. This allows for a higher compression ratio,

which helps to deliver more output at the same time as enhanced engine efficiency. Injection is regulated by the electronic engine management system and emissions are monitored by the stereo Lambda sensors, thus helping to protect the environment.





VarioCam Plus

**VarioCam Plus.**

VarioCam Plus is a two-in-one engine concept for adjusting the intake camshafts and switching the lift of the intake valves.

The system first differentiates between driver inputs that typify normal, everyday driving and those inputs that demand maximum performance. The electronic engine management system then seamlessly adapts valve operation to the prevailing conditions. This results in instant acceleration and extremely smooth running.

In the middle and low load ranges, low valve lifts with advanced timing reduce fuel consumption and exhaust emissions and improve smooth running. The increase in fuel economy is particularly pronounced in the lower engine speed range. High torque and maximum output are achieved through high valve lifts and advanced timing.

How does this benefit you?  
Extraordinary power with relatively low fuel consumption.

**Exhaust turbocharging.**

The Panamera Turbo has two turbochargers arranged in parallel. Intake air is compressed and then fed to the engine via two charge-air coolers, one for each cylinder bank. Cooling of the compressed air has two positive outcomes: high cylinder charge and low component temperatures. Under full load, the boost pressure depends on the current engine speed and a maximum pressure of 0.85 bar is achieved at 2,500 rpm at sea level.

With the optional Sport Chrono Package Turbo, the boost pressure produced at full throttle in the 2,000 rpm to 5,000 rpm range is temporarily increased by up to 10% by the 'overboost' function.

**Lightweight exhaust system.**

The exhaust system is made from selected longlife stainless steel. The powerful primary and main catalytic converters heat up rapidly for effective emissions control. As a result, all Panamera models are equipped to meet the Euro 5 emission standard in Europe.

The exhaust system of the Panamera Turbo switches between two configurations automatically: low noise at low engine speeds, and increased throughput at high revs under maximum engine load.

**Sports exhaust system.**

An optional sports exhaust system is available for the Panamera S models and Panamera Turbo. Activated by a separate button, it produces an even more authentic sports car sound.



Panamera 4S with sports exhaust system

**You don't always want to hand over control, sometimes you prefer to get involved.**

**Transmission.**

**Six-speed manual gearbox.**

For precision handling: the 6-speed manual gearbox fitted as standard in the Panamera and Panamera S

is tuned for sporty performance with optimum connection to the individual gears and extremely precise shift throws.

Thanks to the elevated centre console, the gear lever is within easy reach – ideal for sporty shifting. The cable-operated gearshift unit has a precise feel and the gear lever is insulated against vibration. Together with the dual-mass flywheel, this minimises noise and is key to providing a high level of comfort.

An upshift indicator in the instrument cluster helps to further improve fuel economy. Porsche Doppelkupplung (PDK) is available as an option for both of these models.



Gear lever

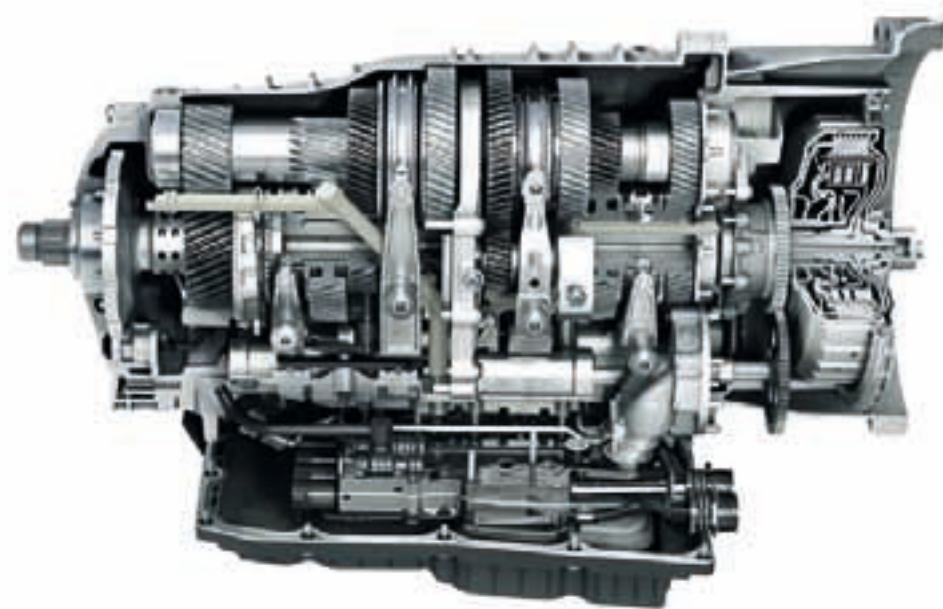

Porsche Doppelkupplung (PDK)

**Porsche Doppelkupplung (PDK).**

The 7-speed PDK – fitted as standard in the Panamera 4, Panamera 4S and Panamera Turbo and available as an option in the Panamera and Panamera S – has both a manual gearshift and an automatic mode and enables smooth gear changes with no interruption in the flow of power.

Gears 1 to 6 have a sports ratio and top speed is reached in 6th gear. The 7th gear has a long ratio, which reduces fuel consumption even further and keeps engine revs comfortably low even at high road speeds.

PDK is essentially two gearboxes in one and thus requires two clutches. This double clutch provides an alternating, non-positive connection between the two half gearboxes and the engine by means of two separate input shafts (input shaft 1 is nested inside the hollowed-out input shaft 2).



The flow of power from the engine is transmitted through one half gearbox and one clutch at a time, while the next gear is pre-selected in the other half gearbox. During a gear change, therefore, a complete shift no longer takes place. Instead, one clutch simply opens and the other closes at the same time. Gear changes can therefore take place within a few hundredths of a second.

Clutch 1 controls the first half gearbox, which contains the odd gears (1, 3, 5 and 7). Clutch 2 controls the second, which contains the even gears (2, 4, 6 and R). The gear which is engaged is displayed on the instrument cluster.

PDK has distinct benefits. A high level of driving comfort and very rapid gearshifts, with no interruption in the flow of power, produces faster acceleration. Driving feels even sportier and more dynamic, and agility is increased. Depending on the gearshift programme (SPORT button

activated or deactivated), the gear change is optimised for comfort or for sporty driving. Its high level of efficiency combined with the long-ratio 7th gear helps to achieve reduced fuel consumption and emission figures even when compared with a standard manual gearbox.

In conjunction with either the optional Sport Chrono Package Plus (p. 74) for all Panamera models with a naturally aspirated engine or the optional Sport Chrono Package Turbo for the Panamera Turbo (p. 76), PDK is enhanced by a Launch Control function which offers a sportier acceleration and gearshift strategy in automatic mode and extremely smooth gear changes in manual mode.

PDK offers sportiness with efficiency and comfort. A new definition of driving in the premium class from Porsche.

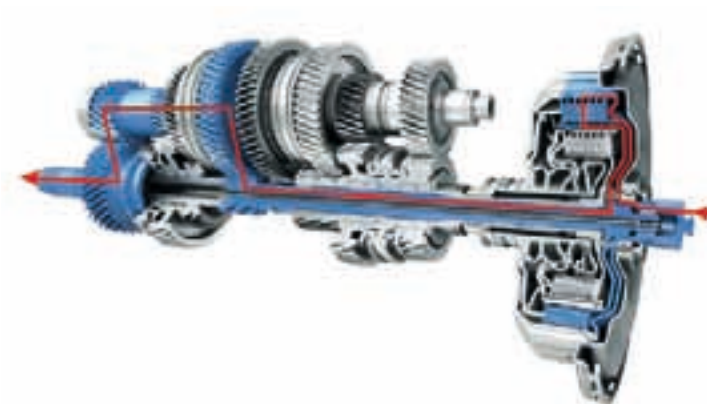

Power flow in 1st gear



Power flow in 2nd gear





PDK gear selector



Three-spoke steering wheel for PDK

**Three-spoke sports steering wheel with gearshift paddles.\***

Available as an option is the three-spoke sports steering wheel with gearshift paddles. The paddles are made from a strong alloy and are ergonomically located behind the right and left steering wheel spokes. Pull the right-hand paddle and the PDK shifts up. Pull the left-hand paddle and the PDK shifts down.

Visually, the steering wheel is distinguished by its distinctive high-quality twin-spoke design and silver-coloured spoke cover.

This steering wheel also has an additional display when combined with the Sport Chrono Package. Located in the left and right-hand steering wheel spokes, it tells you whether SPORT, SPORT PLUS and Launch Control are activated.

Another feature reminiscent of the world of motorsport is the top centre marking on the steering wheel rim.

\* For Panamera S, Panamera 4S and Panamera Turbo, available from 09/2010 at the earliest.

**Three-spoke sports steering wheel with gearshift switches and multifunction option.**

In conjunction with the optional PDK, the three-spoke sports steering wheel fitted as standard has two ergonomic switches for changing gear. One press forwards with the thumb and PDK shifts up. One pull backwards with the index finger and PDK shifts down. Either the right or left hand can be used.

Even if the gear selector is set to automatic, you can still use the switches to change gear manually at any time. In this way, even in automatic mode, you can achieve a short burst of speed for an overtaking manoeuvre. The system reverts to automatic mode if no manual inputs are detected for approximately eight seconds.

Using the PDK gear selector, you can also change gear manually in a separate one-touch manual shift gate. The control concept mirrors the logic of the switches on

the PDK steering wheel – press forwards to shift up, pull backwards to shift down.

A multifunction version of the three-spoke sports steering wheel is available on request. Steering wheel heating is also optional.

When combined with the Sport Chrono Package, there is an additional display\* above the airbag module. It tells you whether the SPORT, SPORT PLUS and Launch Control functions are activated.



Three-spoke multifunction steering wheel



Three-spoke sports steering wheel with gearshift paddles

**You always like to have your feet firmly planted on the ground.  
With all-wheel-drive, the principle is the same.**

**Porsche Traction Management (PTM).**

Fitted as standard in the new Panamera 4, the Panamera 4S and the Panamera Turbo, Porsche Traction Management (PTM) comprises an active all-wheel drive with electronic and map-controlled multi-plate clutch with automatic brake differential (ABD) and anti-slip regulation (ASR).

The electronically controlled multi-plate clutch regulates the distribution of drive force between the permanently driven rear axle and the front axle.

Through continuous monitoring of the driving conditions, the electronics are able to respond to a

variety of situations. Sensors check, among other variables, the rotation speeds of all four wheels, the longitudinal and lateral acceleration of the vehicle, and the steering angle.

If the rear wheels threaten to spin under acceleration, a greater



All-wheel drive



proportion of drive force is distributed to the front by a more powerful engagement of the multiplate clutch. In addition, ASR reduces wheel slip. When cornering, the front wheels only ever receive as much drive force as is necessary to maintain optimum lateral stability.

In this way, PTM, in conjunction with Porsche Stability Management (PSM, p. 72), ensures that the perfect distribution of drive is achieved every time: whether on long straights, through tight corners, or on surfaces with different friction coefficients. In this situation, traction is additionally

enhanced by the automatic brake differential (ABD).

Whenever the brake control systems are required to intervene, PTM decouples the front axle completely so that PSM interventions can take place at each individual wheel.

**Unfortunately, the condition of the roads is beyond our control.  
We'll just make the car adapt instead.**

### Chassis.

Through the purposeful use of lightweight technologies, we have managed to save weight in the chassis and increase efficiency. The next challenge was the question of how to reconcile the characteristics of a sportscar with the requirements for comfort demanded of a saloon. The answer: modern axle concepts. Two apparently more mutually exclusive qualities are high performance and excellent driving safety, which we resolved with precise traction control systems and powerful tyres and brakes.

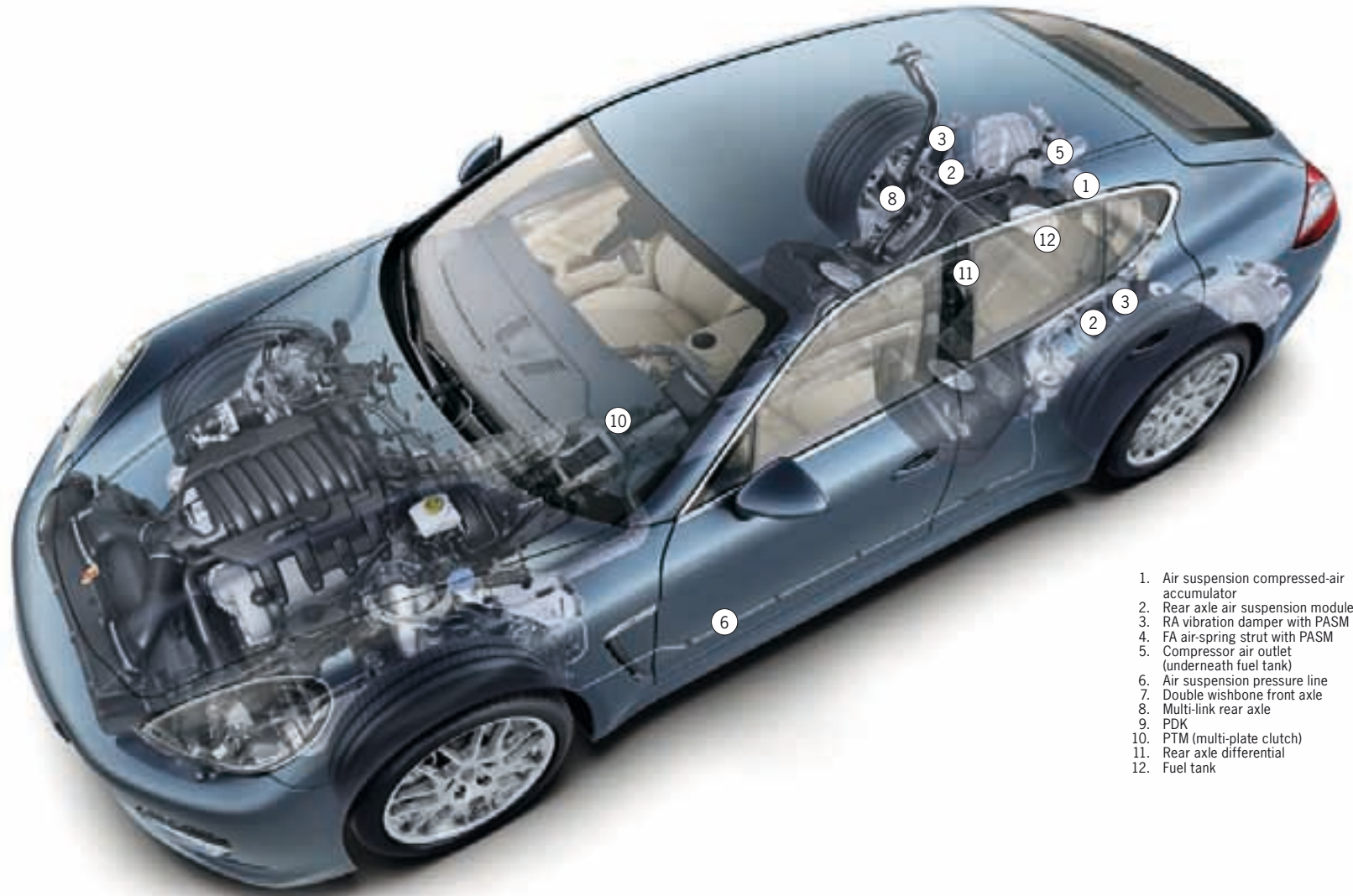

1. Air suspension compressed-air accumulator
2. Rear axle air suspension modules
3. RA vibration damper with PASM
4. FA air-spring strut with PASM
5. Compressor air outlet (underneath fuel tank)
6. Air suspension pressure line
7. Double wishbone front axle
8. Multi-link rear axle
9. PDK
10. PTM (multi-plate clutch)
11. Rear axle differential
12. Fuel tank



Panamera Turbo front axle

The rear axle is an aluminium multi-link setup. This axle design minimises the pitching of the body under acceleration and braking.

The high proportion of aluminium used in the construction of the axles reduces the weight of the vehicle and of the unsprung masses, helping to improve fuel economy and increase agility.

**Steering and Servotronic.**

Precise and direct: describes a typical Porsche steering system – with variable steering ratio.

Around the straight ahead position, such as during motorway driving, the ratio is less direct with no loss of agility or feedback from the road. When the steering wheel is turned further, the ratio becomes more direct, allowing easier cornering and parking.

Servotronic, a speed-sensitive power-steering system, is available as an option for all Panamera models. At high speeds, the steering is firm and responds with extreme precision while steering

comfort remains as high as you would expect. At low speeds, Servotronic's ratio adjusts for easy manoeuvring and parking.

**Wheels and Tyre Pressure Monitoring (TPM).**

The new Panamera and Panamera 4 models are fitted as standard with 18-inch Panamera wheels, the Panamera S and 4S with 18-inch Panamera S wheels. All wheels are lightweight alloys featuring a classic sporty design. Tyre sizes 245/50 ZR 18 and 275/45 ZR 18 are fitted to the front and rear, respectively.

The Panamera Turbo is equipped with 19-inch Panamera Turbo alloy wheels as standard. The tyres are slightly wider to cope with the increased power output of this model: 255/45 ZR 19 at the front, 285/40 ZR 19 at the rear.

A selection of 18-inch to 20-inch wheels is available from our range of options (p. 147).

19-inch all-season tyres are offered as an alternative at no extra cost for all Panamera models with standard or optional 19-inch wheels. A low-rolling resistance version of these tyres is available as an option\*. The three main components of the

tyre – the rubber compound, the tread pattern and the architecture of the tyre substructure – have been optimised to minimise roll resistance and thus improve fuel economy, with no effect on comfort or performance compared with the regular 19-inch all-season tyres.

For increased comfort and safety, Tyre Pressure Monitoring (TPM) sends warnings to the on-board computer's display screen in the event of low tyre pressure as well as in the event of a loss of pressure. The system is available as an option for the Panamera and Panamera 4 and is standard in all other models.

\* Available from 10/2010 at the earliest.

**Suspension.**

The front axle has a wide-spaced aluminium double wishbone arrangement with an aluminium

subframe. The wide spacing between the wishbones keeps the forces in the wheel suspension low for precision wheel guidance and excellent handling.



Panamera Turbo rear axle



18-inch Panamera wheel



18-inch Panamera S wheel



19-inch Panamera Turbo wheel

**The road to success is rarely a smooth one.**

**Porsche Active Suspension Management (PASM).**

Standard in the Panamera S, 4S and Turbo and optional for the Panamera and Panamera 4, PASM is an electronic damping control system which offers continuous adjustment of the damping forces according to the road conditions and driving style.

Designed to operate in accordance with the skyhook principle,

the suspension acts to keep the body stable. This reduces body movement and thus increases comfort in each of the four seats.

Using a separate button on the centre console, the driver can select between three modes: 'Comfort', 'SPORT' or 'SPORT PLUS'. Sensors record the body movements that accompany

powerful acceleration, braking and rapid cornering or uneven road surfaces.

Signals such as lateral acceleration, steering angle, brake pressure and engine torque are also analysed. The PASM control unit evaluates the driving conditions and modifies the damping force on each of the wheels in accordance with the selected mode.

For your safety, PASM continuously monitors the driving conditions. If you are driving in 'Comfort' mode and suddenly adopt a sportier and more dynamic driving style, the system automatically switches to a harder rating within the 'Comfort' setup range to increase driving stability and safety.

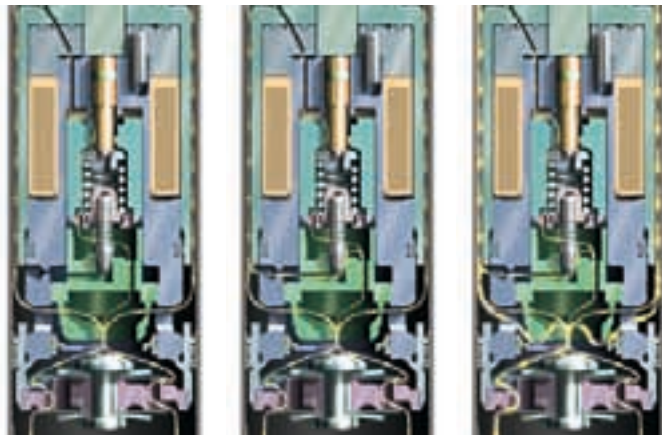

Continuous adjustment based on load and speed



If, in 'SPORT' or 'SPORT PLUS' mode, the quality of the road surface drops below a certain threshold, PASM immediately switches to a softer rating within the setup range to optimise traction and grip. As soon as

the road surface improves, the system reverts to the original harder rating.

This may sound rather complicated, but for you it involves nothing more than the press of

a button. And you can feel the result: increased driving stability, more comfort and improved performance.



**Adaptive air suspension.**

The Panamera Turbo is equipped with adaptive air suspension and PASM as standard. This combined system enhances both driving dynamics and comfort at the same time. For all other Panamera models, adaptive air suspension is available as an option.

It comprises a levelling system, a manual lift function, ride-height adjustment capability and the ability to vary the spring rate.

The purpose of the levelling system is to automatically keep the vehicle level constant, regardless of load distribution. For manoeuvring, the manual lift function enables you to raise the vehicle body by 20 mm to

minimise the risk of grounding, e. g. when entering garages.\* When you select the 'SPORT PLUS' chassis programme, the height of the body automatically drops to Low Level (-25 mm). At the same time, a harder spring rating is achieved through a reduction in the amount of air stored in the air suspension. In simple terms, it's a sports chassis at the push of a button.

\* The vehicle must not be driven at High Level on public roads as the maximum permissible installation height of the reflector units may then be exceeded.

**High Level.**

At 20 mm above Normal Level, this is intended for driving over ramps and into garage entrances. The chassis automatically reverts to Normal Level as soon as the vehicle reaches a speed of 18 mph (30 km/h).



**Normal Level.**

The usual height for the system with a maximum ground clearance of 144 mm above DIN unladen weight.



**Low Level.**

This is 25 mm below Normal Level with a maximum ground clearance of 119 mm. In 'SPORT PLUS' mode, the vehicle body drops to Low Level and a harder spring rate is set. This assures optimum roadholding with a sporty driving style.



**A wavering course was never your thing.**

**Porsche Dynamic Chassis Control (PDCC) with Porsche Torque Vectoring Plus (PTV Plus).**

A Porsche holds the road well, its handling is sporty and precise – but you’ve known this for a long time.

What you might not know is that, with the optional Porsche Dynamic Chassis Control (PDCC) with Porsche Torque Vectoring Plus (PTV Plus), road holding can be even further improved in all the

Panamera models for even more dynamic performance and increased comfort.

PDCC is an active anti-roll system that anticipates and significantly reduces lateral body movement during cornering manoeuvres. In addition, it minimises the lateral instability of the vehicle on uneven ground. The effect is achieved

with the aid of active anti-roll bars on the front and rear axles which respond to the current steering angle and lateral acceleration by producing a stabilising force that precisely negates the roll of the body.

PTV Plus combined with PDCC is a system that actively enhances vehicle dynamics and stability.

Operating in conjunction with an electronically regulated rear differential lock, it works by varying the torque distribution to the rear wheels. As a function of steering angle and steering speed, accelerator pedal position, yaw rate and vehicle speed, PTV Plus is able to improve steering response and steering precision by specific braking of the right or left rear wheel.

To be more precise, this means that when the car is driven assertively into a corner, moderate brake pressure is applied to the

inside rear wheel. Consequently, a greater amount of drive force is distributed to the outside rear wheel, inducing an additional rotational pulse (yaw movement) around the vehicle’s vertical axis. This results in a direct and sporty steering action as the car enters the corner.

At low and medium vehicle speeds, PTV Plus significantly increases agility and steering precision. At high speeds and when accelerating out of corners, the electronically regulated rear differential lock ensures greater driving

stability. It also serves to improve traction at the rear wheels on road surfaces with varying levels of grip as well as on snow and ice.

For the driver, this means remarkable stability and easier handling, optimum traction, and greater agility at every speed with precise steering and stable load transfer characteristics. The result is a high level of driving pleasure.



Rapid cornering in the Panamera S without PDCC (illustrative example)



Rapid cornering in the Panamera Turbo with PDCC (illustrative example)

**Even a Porsche has limits to its dynamic performance.**

**Porsche Stability Management (PSM).**

As standard, all Panamera models are equipped with enhanced Porsche Stability Management (PSM), which maintains stability even at the limits of dynamic driving performance. Sensors continuously monitor the direction, speed, yaw velocity and lateral acceleration of the car. Using this information, PSM is able to

calculate the actual direction of travel at any given moment. If the car begins to oversteer or understeer, PSM applies selective braking on individual wheels to restore stability.

Under acceleration on wet or low-grip road surfaces, PSM improves traction – and agility – using the automatic brake differential (ABD),

antislip regulation (ASR) and engine drag torque control (MSR).

When 'SPORT PLUS' mode is selected on the optional Sport Chrono Package Plus (p. 74) or Sport Chrono Package Turbo (p. 76), the PSM intervention threshold is raised to allow a sportier driving style.

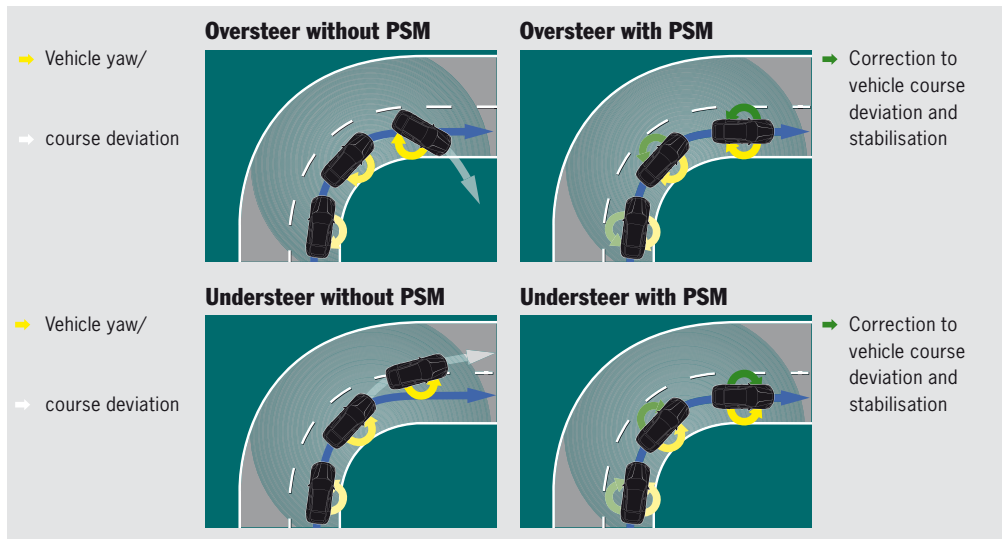

For an even more dynamic experience, you always have the option to deactivate PSM. It is automatically reactivated, for your safety, only if you brake harder and either of the front wheels (in SPORT PLUS mode, both of the front wheels) requires ABS assistance. ABS and ABD, however, remain active at all times.

For an even higher level of active safety, the enhanced PSM includes two additional functions: pre-charging of the brake system, and brake assist.

If you suddenly release the accelerator pedal, PSM detects the release of the throttle and automatically readies the braking system. This precharging of the braking system builds up a small amount of pressure so that the brake pads are already in light contact with the brake discs. If you actually need to apply the brakes, maximum braking power is therefore achieved much sooner, which reduces the stopping distance even further. Brake assist, on the other hand, is able to interpret a panic braking

situation from a rapid increase in brake pressure and acts to ensure that the amount of brake pressure required for maximum deceleration is immediately available.

PSM therefore offers a high level of driving stability and safety combined with extraordinary agility. In line with the Porsche philosophy.



**Your mind is somewhere else.  
How are you going to get there?**

### Performance enhancement systems.



SPORT buttons in the centre console

more direct. In vehicles with Porsche Doppelkupplung (PDK), upshifts in automatic mode take place at higher engine speeds than in 'Comfort' mode and downshifts are swifter. In addition, Porsche Active Suspension Management (PASM) and Porsche Dynamic Chassis Control (PDCC) also switch to 'SPORT' mode to deliver harder damping and more direct steering and, therefore, better road holding.

#### SPORT button.

The SPORT button, which is fitted as standard, enables you to select a setup that favours either comfort or sporty performance. At the push of a button, the electronic engine management system switches the engine mapping to offer an even sharper response and engine dynamics that are

#### Sport Chrono Package Plus.

You expect sporty performance, otherwise you wouldn't be considering a Porsche. Indeed, you expect a higher level of sporty performance, otherwise you would have no urge to keep reading. Available as an option for all Panamera models equipped with the naturally aspirated engine

is the Sport Chrono Package Plus (only in conjunction with Porsche Communication Management – PCM). This package offers even sportier tuning of the chassis and engine setup – the ultimate sports experience.

Included in the package are a digital and analogue stopwatch, the SPORT PLUS button, and a performance display in the PCM for displaying lap times.

When the SPORT PLUS button on the centre console is selected, the engine management system adapts for performance driving and the rev-limiter is adjusted to a harder setting.

The Porsche Active Suspension Management (PASM) – standard in the Panamera S, 4S and Turbo, optional for the Panamera and Panamera 4 – also switches to

'SPORT PLUS' mode for harder damping and more direct steering, and, therefore, better road holding. The optional adaptive air suspension (standard in the Panamera Turbo) drops the chassis to Low Level and hardens the spring rate.

In 'SPORT PLUS' mode, the trigger threshold for PSM is raised for increased longitudinal and lateral dynamics. Agility is enhanced when braking for corners with PSM enabling greater manoeuvrability under braking and exit acceleration, especially at low speeds.

For maximum dexterity, PSM can be set to standby while the car is still in 'SPORT PLUS' mode. For safety, it is set to intervene automatically only when ABS assistance is required on both the front wheels.

A key component of the Sport Chrono Package Plus is the stopwatch mounted on the dashboard. It displays recorded driving time in hours, minutes and seconds. Seconds, tenths and hundredths of a second appear on a display



Digital and analogue stopwatch on the dashboard

screen. Alternatively, the stopwatch can be used as a conventional clock. Porsche Communication Management (PCM, p. 108) has a special performance display to view, store and evaluate lap times or other driving times. It shows the total driving time, lap distance, lap number and lap times recorded so far. You can view the current fastest lap and

the remaining range until empty. It is also useful away from the racetrack. Evaluate your daily mileage or define benchmark times – and rediscover your old routes.

For the Panamera 4 and 4S, and for the Panamera and Panamera S when fitted in combination with Porsche Doppelkupplung (PDK), the optional Sport Chrono Package Plus contains even more functions.

The shift times in 'SPORT PLUS' mode are shorter, the gear changes sportier. In automatic mode and at low rates of deceleration – even with high engine speeds – the system initiates a swifter brake-induced downshift. In manual mode, gear changes are faster, more dynamic and more direct.

A special feature of this package that further enhances sporty performance is Launch Control, which is designed to produce optimum acceleration from a standing start. This function is operated via the SPORT PLUS button with the 'D' or 'M' drive position selected. With the left foot depressing the brake pedal, the driver fully depresses the accelerator for maximum throttle. The engine is revved to an optimum speed of around 5,500 rpm and the clutch is already held in slight contact. The message 'Launch Control



active' appears in the display on the steering wheel for PDK\* or optional three-spoke sports steering wheel with gearshift paddles\*. Now, the driver simply releases the brake pedal, and prepares for maximum acceleration.

#### **Sport Chrono Package Turbo.**

For the Panamera Turbo, increased power output is a matter of principle. The same applies to the optional Sport Chrono Package Turbo. Typifying the Turbo philosophy, it not only combines all the

functions of Sport Chrono Package Plus, it adds one more: Overboost.

Imagine you are accelerating at full throttle with the SPORT or SPORT PLUS button selected. Boost pressure is temporarily increased by 10%, which

considerably increases the maximum torque that the engine is able to produce. Instead of the normal 700 Nm, the overboost function generates a torque of up to 770 Nm for a limited period and a feeling of satisfaction that lasts even longer.

\* For Panamera S, Panamera 4S and Panamera Turbo, available from 09/2010 at the earliest.



## Balance

Sportiness and environmental responsibility do not have to be mutually exclusive. After all, you want to do your part for the environment and do so without having to make sacrifices. What about safety? No, we don't see any contradiction either. No reason, then, to look so serious.

**Nice to know that quick and safe evasive manoeuvres are possible in an emergency.**

**Safety.**

Do you leave chasing after the latest technological fad to others? Do you instead place value on that which is useful, sensible, and reliable? We're on the same wavelength.

**Lighting concept.**

All models are equipped with a driving light assistant, which switches the lights on automatically when it gets dark. As

standard, all Panamera models feature Bi-Xenon headlights with dynamic range adjustment and a headlight cleaning system. With dipped or main beam, the road ahead is illuminated more

uniformly. The lighting system features an automatic switch-off and the 'Welcome Home' function – a customisable delayed switch-off timer that keeps the daytime running lights, the taillights and, where applicable, the courtesy lights (p. 83) switched on until you reach your front door.

Standard equipment on all Panamera models are the LED daytime running lights. On the Panamera Turbo, each headlight unit has four LED spotlights; on all other models, the LEDs are arranged horizontally in the front light units. Daytime running lights improve safety in the daytime as they make you more visible to other road users.

Also contained in the front light units are the direction indicators, bar-shaped LED light guides in the form of position lights or – exclusively reserved for the Panamera Turbo – LED light guides as a border for the indicators.



Panamera S and Panamera 4S night light design



Panamera Turbo night light design



Night light design Panamera models



Cornering lights of the Porsche Dynamic Light System (PDLS)

The Porsche Dynamic Light System (PDLS) is standard on the Panamera Turbo and available as an option for all other Panamera models. Its dynamic cornering light function swivels the headlights towards the inside of a bend based on steering angle and road speed and the static cornering lights activate the auxiliary headlights in order to illuminate more of the road on tight bends and turns. Put simply, when you enter a bend, the road ahead is illuminated immediately so you can see any obstacles much sooner.

The system also features speed-dependent headlight range control. With adaptive light systems, it is possible for the maximum range of the dipped beams to be increased as a function of the speed of the vehicle. PDLS takes care of this automatically. Stage 1 is the basic position for driving

in city traffic, for example. Stage 2 is for driving at faster speeds, such as on the motorway. Here, the range of the dipped beams is adjusted by adapting the shape of the light cone, extending it further forward to improve visibility without dazzling oncoming traffic.

Another feature of the PDLS, the adverse weather function, is activated when you switch on the rear fog light. It reduces the effect of reflection phenomena in poor visibility conditions, e.g. fog, heavy rain or snowfall. The dipped beams are fanned out and the light cone is lowered to reduce the risk of the driver being dazzled.

Vehicles with the driver memory package or 14-way power seats with memory package (standard in the Panamera Turbo) feature

LED courtesy lights in the exterior mirrors to illuminate the area around the doors.

In the event of sudden braking, the adaptive LED brake lights of the Panamera model range pulsate to alert following traffic more quickly to a critical situation.

Cutting edge LED technology is also used for the taillights, the additional brake light in the rear lid, the rear direction indicators and the rear fog light. LEDs provide better illumination and respond more quickly to driver input. Not only do they increase active safety in this way, they are energy efficient, eco-friendly and have a longer service life than conventional bulbs. Furthermore, their design is unmistakably Porsche, day or night.

**On any long journey, there will come a time when you have to stop.**

**Brakes.**

Porsche brakes are renowned for their stopping power, setting the standards for deceleration and stability. They are designed to cope with extreme forces such as those experienced during hard braking.

The Panamera, Panamera 4, Panamera S and Panamera 4S all have a braking system equipped with six-piston aluminium monobloc fixed brake calipers at the

front and four-piston aluminium monobloc fixed calipers at the rear. The brake calipers on the Panamera and Panamera 4 are finished in black; on the Panamera S and Panamera 4S, they are silver-coloured. The brake disc diameters are 360 mm and 330 mm at the front and rear respectively.

Owing to its greater engine power, the Panamera Turbo's

braking system features red-painted six-piston aluminium monobloc fixed brake calipers at the front and a four-piston unit at the rear, and brake discs with a diameter of 390 mm at the front and 350 mm at the rear for outstanding braking performance and a short braking distance.

The brake calipers have an enclosed monobloc construction. This makes them tough but light



Standard brake system on Panamera and Panamera 4



Standard brake system on Panamera S and Panamera 4S



Standard brake system on Panamera Turbo

and enables a rapid response and release of the brake. The pedal travel is short and easy to control.

All models have grooved brake discs ensuring optimum braking even under extreme conditions. The discs are internally vented for rapid heat dispersal.

The Panamera models are also equipped with an anti-lock braking

system (ABS), designed to keep deceleration constant. A specially designed air duct cools the brakes effectively and, for added safety, a brake pad wear indicator for each wheel informs you when the brake pads need to be replaced.

The electric parking brake, which you can activate and deactivate manually, releases automatically as you pull away. With the hill-hold

function, you can pull away without ever rolling back. The system automatically detects when the vehicle has come to a halt on an uphill gradient. PSM then maintains the brake pressure at all four wheels for a brief period to prevent the vehicle from moving in the opposite direction.

**Presumably, you won't be using your Panamera for motorsport activities. But you never know.**

**Porsche Ceramic Composite Brake (PCCB).**



PCCB

Brake (PCCB). For the Panamera and Panamera S models, it is available only in conjunction with 19-inch wheels or larger and for the Panamera Turbo, it is compatible only with 20-inch wheels.

On the Panamera and Panamera S models, the cross-drilled ceramic brake discs have a diameter of 390 mm at the front and 350 mm at the rear. To cope with more powerful braking on the Panamera Turbo, these discs are 410 mm at the front and 350 mm at the rear.

PCCB is characterised by its low thermal expansion, which prevents deformation under heavy braking. Furthermore, the ceramic brake discs are totally resistant to corrosion and offer more favourable noise-damping properties.

On request, we can equip any Panamera model in the range with a braking system that has already had to cope with the harshest requirements of the racetrack: the Porsche Ceramic Composite

The use of six-piston aluminium monobloc brake calipers on the front axle and four-piston units at the rear – all finished in yellow – ensures extremely high brake forces which, crucially, are exceptionally consistent. The pedal response is fast and precise with only moderate input required.

All the necessary ingredients are there for a short braking distance, even in the toughest conditions. Moreover, safety under braking at high speeds is increased thanks to the excellent fade resistance of PCCB.

The key advantage of PCCB is the extremely low weight of the ceramic brake discs, which are approximately 50% lighter than standard discs of similar design and size. As well as enhancing performance and fuel economy,

this represents a major reduction in unsprung and rotating masses. The consequence of this is better road holding and increased comfort, particularly on uneven roads, as well as greater agility and improved handling.

Please note that circuit racing, track day use and other forms of performance driving can significantly reduce the service life of even the most durable brake pads and discs.

As with conventional high-performance braking systems, we recommend that all brake components be professionally inspected and replaced where necessary after every track event.



**It sometimes pays to be a tough nut to crack.**

**Engineered safety design.**



- Magnesium
- Aluminium
- Deep-drawn steels
- Super-high-strength micro-alloyed steels
- Polyphase steels
- Boron-alloyed steels

The ongoing development of the lightweight steel construction used in Porsche vehicles makes a key contribution to the level of safety offered by the Panamera model range. Indeed, the rigidity of the bodywork is exemplary.

The fully galvanised and light-weight hybrid construction, made from super-high-tensile and stainless steels, magnesium and aluminium, produces a highly resilient passenger cell that offers high levels of protection in the event of an impact. A patented system of longitudinal and transverse members at the front gives three separate load paths that absorb energy, disperse the force

of impact and minimise deformation of the passenger cell. Passive safety is further enhanced by the aluminium subframe on the front axle, which is designed to deform in a defined manner.

A rigid bulkhead cross member reduces deformation of the footwell in the event of an impact and provides improved protection for the feet and legs. In a minor collision, a system of easily replaceable impact absorbers prevents costly damage to the underlying bodyshell.

The axles, bonnet, front wings, doors and rear lid are made of aluminium, which saves on weight and therefore fuel.

**Active bonnet system.**

The active bonnet system is designed with enhanced pedestrian safety in mind. When the sensors in the front apron detect a collision, this pyrotechnically assisted system raises the rear portion of the bonnet, which can help to reduce the risk of injury.



Active bonnet system



**A high level of protection will ensure that composure is maintained.**

**Airbags.**

In all Panamera models, we use advanced airbag technology in the form of full-size driver and front passenger airbags which are inflated in two stages depending on the severity and type of accident (e.g. frontal or offset frontal). Two sensors in the front end allow a crash to be detected and evaluated far sooner and with considerably greater accuracy. In less serious accidents, the airbags are only partially inflated, thereby minimising discomfort to the occupants.

As standard, the knee airbags for the driver and front passenger are supplemented by the Porsche Side Impact Protection System (POSIP). This comprises two-chamber side airbags for the pelvis and thorax regions, curtain airbags along the entire roof

frame and the side windows from the A-pillar to the C-pillar, and side impact protection elements in the doors. Side airbags in the rear compartment are available as an option.

The headrests are integrated into the backrest. Also featured as standard are an energy-absorbing steering column, three-point seat-belts at all seats, height adjustment and seat-belt force limiters in the front and seat-belt pretensioners in the rear, energy-absorbing elements in the dashboard and flame-retardant materials throughout the interior.

A rollover sensor automatically activates the curtain airbags and seat belt pretensioners if the vehicle threatens to overturn.



**As a Panamera driver, you are responsible for four people.  
We are responsible for everyone else.**

**Porsche and the environment.**

**Environmental protection.**

In an era of intensifying debate about global climate change and CO<sub>2</sub> emissions, every automotive

manufacturer is asking what it has to offer in terms of environmental protection. Our answer has long been the same: maximum efficiency.

Porsche has been reducing the CO<sub>2</sub> emissions of its vehicles by an average of around 1.7%\* every year for the past 15 years. As far as engine output is

concerned, we are already among those manufacturers achieving the lowest CO<sub>2</sub> emissions. This has been achieved through the new efficient engine technology (e.g. by DFI and VarioCam Plus), lightweight construction, optimum aerodynamics and low rolling resistance.

This high level of environmental responsibility is clearly demonstrated by our approach to environmental management at the Porsche Development Centre in Weissach. Here, all technological developments are carried out with environmental protection in mind. The goal is pure performance – but not at the expense of the environment. A goal achieved by the Panamera.

**Fuel economy and emission control.**

Vehicles manufactured by Porsche demonstrate that even high-performance sportscars can achieve moderate fuel consumption and exhaust emission values in their respective category.

The balance is exemplary: the Panamera, Panamera 4 and Panamera Turbo comply with the Euro 5 emission standard in Europe and the LEV regulations in the USA, the Panamera S and

Panamera 4S meet the requirements of EU 5 and ULEV.

This is achieved through the use of fuel-efficient technologies such as direct fuel injection (DFI, p. 51) and VarioCam Plus (p. 52).

Efficient emission control is achieved by a two-stage cascade-type catalytic converter, which comprises two monoliths arranged in series. These specially coated substrates contain ultra-fine honeycomb channels in which pollutants are converted as exhaust gas passes through.

The stereo Lambda control circuitry controls and monitors each cylinder bank separately. For each exhaust tract, oxygen sensors regulate the composition of the exhaust gas, while another Lambda sensor on each cylinder bank monitors pollutant conversion in the respective catalytic converter.\*\*

\* The stated reduction in fuel consumption has been calculated from the NEDC (New European Drive Cycle) fuel consumption figures for the respective model years of the vehicles and in relation to the applicable European legislation.  
\*\* Not in markets with leaded fuel.



In models with the V8 engine, exhaust gas cleaning is supported by an air injection system. A compressor pumps extra air into the exhaust tract during the catalytic converter warm-up phase for faster heating and, therefore, lower emissions.

Other measures for improving fuel economy are the Auto start/stop function (p. 50) and electrical system recuperation, whereby the vehicle battery is charged predominantly under braking. Under acceleration, on the other hand, the charging current of the regulated alternator is reduced so that the engine does not need to work as hard to charge the battery.

#### **Lightweight construction and recycling.**

A fundamental objective in the development of any Porsche is intelligent lightweight construction. For both economical and ecological reasons. This forms the basis for low fuel consumption values in

conjunction with outstanding performance. It is economical thanks to the high proportion of aluminium cast alloys, plastics and super-high-strength sheet steel used. This is substantially more stable and lighter than conventional steel. The Panamera models have a bodyshell with a lightweight-metal content of 23%. For example, the bonnet, doors, front wings and rear lid are made of aluminium, which saves on weight and has a positive effect on the environmental balance: according to eco balance sheets, the extra energy used and the higher emissions incurred in the manufacturing of aluminium are more than compensated by the savings on fuel after only a relatively short distance.

It is also responsible because all materials used are meticulously selected. We use only innovative and environmentally friendly components. All lightweight materials are easily recyclable and each material is labelled to facilitate its separation for recycling. The

reduction in the number of plastic variants helps to ensure more efficient recycling. Recycled plastics are used where they meet our exacting technical requirements

In all, the Panamera is approximately 95% recyclable.

In addition, Porsche uses only environmentally friendly water-based paints, thus reducing the need for solvents both in production and in the workshop. The Panamera is also absolutely free of asbestos, CFCs and components manufactured using CFCs because, here at Porsche, environmental protection does not begin at the end of a vehicle's life. It starts at the planning and development stage.





### **Servicing.**

Long service intervals are not only more convenient, they reduce ownership costs. They also promote a more sparing use of consumables and replacement parts, which is in both our interests. For you, lower costs and saved time are two major benefits, but perhaps the greatest benefit is for the environment. For full details of service intervals, please refer to the separate price list.

### **Fuel.**

All Porsche models – including the Panamera – are already designed to operate on fuels with an ethanol content of up to 10%. Ethanol has a positive impact on the CO<sub>2</sub>

balance since the plants grown for the production of this biofuel also absorb CO<sub>2</sub> from the atmosphere.

The release of hydrocarbons from the fuel system has been

minimised thanks in no small part to the active carbon filter and the multilayered material from which the fuel tank is made. All fuel lines are made from multilayered plastic, steel or aluminium.

### **Noise.**

The Panamera complies with all applicable noise regulations without any form of engine encapsulation. To achieve this, noises are eliminated at source.

Engine parts are stiff, moving parts are lightweight and tolerances are kept to a minimum. No nuisance noise to be heard, just the characteristic Porsche sound.



## Personality

Is the traditional look of an old-fashioned saloon not the look for you? Would you prefer something less conventional? Then let us break the mould with sports dynamics, with authenticity, with personality.

**Do you like to sit on a seat or in a seat?**

**Comfort.**

**The interior.**

In terms of Porsche design, the Panamera models are, admittedly, a little different from what we are used to. It's no wonder, as they are the first Porsche vehicles to have four individual seats (p. 106). But that's not all.

What strikes you immediately about the front is the elevated centre console. It doesn't look like a saloon does it? That's good, because it does look distinctly like a sports car. Even more importantly, it handles like one. This is thanks in no small part to the extremely short distance between the gear lever and steering wheel – to be more precise, the three-spoke sports steering wheel with smooth-finish leather rim, which is fitted as standard and adjusts for height and reach. A heated

steering wheel is available on request.

Also available as an option for all models is the three-spoke multifunction steering wheel, which has buttons for the convenient operation of a range of radio and, where applicable, navigation and telephone functions. It is finished in smooth-finish leather or, in conjunction with steering wheel heating, any finish of your choice from walnut, tinea, anthracite birch, Yachting Mahogany or carbon.

With these finishes and a selection of other materials offered in the form of predefined interior packages, there is a wealth of ways for you to personalise the interior. Additionally, there are seven interior colours and five two-tone combinations in several

leathers. So you can create a sporty or luxurious feel, or even a blend of both.

All the frequently used controls on the centre console are grouped logically together to enable you to select individual functions quickly and easily.

Just how much attention we have paid to providing space in the passenger compartment can be seen in the details. The Panamera models offer a variety of storage options, e.g. in the doors and centre console. The front centre armrest contains a convenient cupholder. Alternatively, at no extra cost, you can have two additional fold-out cupholders installed above the glove compartment to supplement the two fitted as standard in the rear compartment.



Interior of the Panamera Turbo with optional multifunction steering wheel and Sport Chrono Package Turbo



Front cupholder



Glove compartment



Large centre console in the Panamera Turbo

For extra storage space, a large rear centre console is available as an option. Two 12-volt sockets are included.

The interior lighting concept with switch-off delay was designed with not only practicality in mind but also aesthetic appeal. This

includes illuminated door handles and storage compartments in the front, orientation lighting and front footwell lights. Also, reading lights and interior lights – one of each for all four seats.

An optional interior lighting package conceived specifically for the

rear adds two reading lights to the overhead console, lights in each footwell, additional orientation lighting in the rear, and illumination for door storage compartments and the compartment in the rear centre console. Nearly all lights are powerful yet energy-efficient LEDs. The additional ambient



lighting on the overhead consoles in the front and rear and the reading lights are dimmable.

The rooflining in Alcantara is standard for the Turbo and optional for the other models.

As an option, it is possible to have thermally and noise insulated glass fitted. Alternatively, dark-tinted glazing will maintain your privacy and protect the interior from the effects of strong sunlight. Just like the electric roll-up sunblinds on the rear side windows and behind the rear seats.



Instruments in the Panamera Turbo

**Instruments.**

The five circular dashboard instruments in the Panamera models are quick, clear and easy to read. Typically Porsche.

The instrument cluster with high-resolution 4.8-inch TFT colour screen gives you access to the on-board computer or the navigation system map, for example. It also shows the settings of the optional adaptive cruise control or gives various warnings, such as alerts from the Tyre Pressure Monitoring (TPM).

In the new Panamera and Panamera 4 models, the dial face of the rev counter is black; in the Panamera S and Panamera 4S it is silver-grey, and in the Panamera Turbo it is black and bears the 'turbo' logo.

**Front seats.**

The front seats with integrated headrests offer a high degree of comfort. During cornering, they hold your body firm but without restricting your freedom of movement.

Seat adjustment is fully electric as standard with controls on both the

driver and front passenger sides for seat height, squab and backrest angle, and fore/aft position. A driver memory package, available as an option, enables the driver's seat and exterior mirror positions to be saved and restored automatically.

In the Panamera Turbo, the front seats offer even more functionality. The 14-way power seats with memory package for both driver and front passenger are standard (optional for all other Panamera models). In addition to featuring an electric steering column adjustment facility, this includes electric four-way lumbar support, electric seat squab length adjustment and personal memory for seat, steering wheel and mirror positions. The courtesy lights (LEDs in the exterior mirrors) are a component of the driver memory package and 14-way power seats with memory package.

ISOFIX child seat mounting points are available as an option for the front passenger seat in conjunction with the deactivation function for the passenger airbag.



Standard front seat



Adaptive sports seat (front)

**Adaptive sports seats.**

Do you wish to take sporty driving to an even higher level? That is precisely what the adaptive sports seats were designed for. Available as an option for all Panamera models, they have firmer upholstery and provide even better lateral support thanks to the raised side bolsters on the seat squab and backrest.

Featuring 18-way electric adjustment, the seats can be optimally adapted to meet your needs in terms of seat height, squab and backrest angle, squab length, fore/aft adjustment and 4-way lumbar support. The steering column is also electrically adjustable.

In addition, the side bolsters on the seat squab and backrest are independently adjustable for

added comfort with longitudinal or precision lateral support on winding roads. Also included is the personal memory for the driver and front passenger seats (including lumbar support), the steering wheel and the driver's exterior mirror.



**Rear seats.**

Two fully independent seats with plenty of leg and head room, even for taller passengers. They provide good lateral support, even during fast cornering, with no compromise on comfort. Between the seats is a folding armrest with a handy storage compartment. The backrests fold down individually with a ratio of 40:60 to increase storage capacity or to accommodate unwieldy items. With the optional large centre console, the backrests can still be folded separately while the console itself remains fixed in position.

8-way power seats are available as an option for the rear in any of the Panamera models. In addition to the electric backrest adjustment, seat squab length adjustment and lumbar support

functions, there is a facility to adjust the front passenger seat from the rear.

When specified in conjunction with seat ventilation (p. 150), the 8-way power seats (rear) feature automatic comfort headrests. In conjunction with the adaptive sports seats in the front, sports seats are also fitted in the rear and feature a contrasting seam pattern and elevated side bolsters.

ISOFIX child seat mounting points are fitted as standard on both rear seats in all Panamera models.

**Seat heating and ventilation.**

The front seats of the Panamera S, 4S and Turbo models feature seat heating as standard (optional for Panamera and Panamera 4). This

heats the seat squab and backrest to a pleasant temperature. In the Panamera Turbo, the seats in the rear also have a heating function (optional for all other models).

On request, we can equip the front seats, indeed all four seats, with seat ventilation (only in conjunction with seat heating). A slipstream effect is produced by active ventilation of the perforated seat centre and backrest and by passive aeration at the side bolsters. This evaporates perspiration moisture and therefore makes for a comfortable seating environment, even in hot weather. Seat heating and seat ventilation can be adjusted independently to any one of three power levels. Simultaneous ventilation and heating is possible.



Rear seats

**As well as concentrating on performance, the mind needs to relax from time to time with something light-hearted.**

**Audio and communication.**

**Porsche Communication Management (PCM) including navigation module.**

All Panamera models come equipped with Porsche Communication Management (PCM) as standard. PCM is the central control unit for audio, navigation and communications. It is powerful and multifunctional, yet easy to operate.

The focal point is the intuitive 7-inch high-resolution touch-screen. Alternatively, you can also choose to operate PCM using the conventional button controls. A maximum of five list entries per page ensures clarity

of presentation. A help function is displayed at the bottom of the screen for further guidance in specific situations.

Radio functions include up to 42 memory presets and an FM dual tuner frequency diversity with RDS, which continuously scans in the background for the best signal, and a dynamic autostore.

The DVD-audio drive plays CDs and audio DVDs and is MP3-compatible. Audio playback of video DVDs is also supported. A six-disc CD/DVD autochanger integrated in the centre console is available as an option.

In terms of audio performance, in the Panamera S and 4S a total output of 235 watts is produced through a combination of 11 loudspeakers. Fitted as standard in the Panamera Turbo, the BOSE® Surround Sound System (p. 112) enables the playing of audio sources in the Dolby Digital 5.1 format. For an even greater sound experience, PCM can be combined with the optional Burmester® High-End Surround Sound System (p. 114).



Porsche Communication Management (PCM) including navigation module

In the new Panamera and Panamera 4 models and in the Panamera S and 4S, a total output of 235 watts is produced through a combination of 11 loudspeakers. Fitted as standard in the Panamera Turbo, the BOSE® Surround Sound System (p. 114) enables the playing of audio sources in the Dolby Digital 5.1 format. For an even greater sound experience, PCM can be combined with the optional Burmester® High-End Surround Sound System (p. 116).

In conjunction with the PCM, an optionally available universal audio interface enables you to connect an iPod® or any other compatible MP3 player via the USB port.\* An AUX interface for connecting other audio sources is also provided. An optional hybrid TV tuner is capable of receiving free-to-air analogue and digital broadcasts. PCM can also be used to control the performance display of the optional Sport Chrono Package Plus (p. 74) or Sport Chrono Package Turbo (p. 76).

\* For information on compatibility with iPod® models, please contact your Porsche Centre.

A navigation module with high-speed hard drive is included with PCM. For route guidance, it is possible to select between a 2D display and a new 3D perspective. In some regions, it is even possible for buildings and terrain superimposed with a satellite image overlay to be displayed in 3D. The remaining journey distance is automatically adapted to the maximum screen size. Split-screen mode enables you to view two functions at once, such as the current navigation map and list of symbols representing your next driving instructions.

#### Voice control system.

Do you require navigation assistance, need to make a phone call or simply want to listen to the radio? Then why not just say so? The optional voice control system for PCM is at your command with support for word-by-word input. You can even browse through lists by voice command.

#### Electronic logbook.

An electronic logbook is available for PCM as an option. It enables automatic logging on every journey of mileage, route distance, date, time, starting location and destination. The software fulfils all statutory requirements for automatic logbooks as specified by the German revenue authorities.

#### Telephone module.

Available as an option for the Panamera and Panamera 4 (standard on Panamera S, Panamera 4S and Panamera Turbo), the GSM telephone module offers convenience and excellent reception. By inserting a SIM card directly into PCM's integral SIM card reader, calls can be made using either the hands-free facility or the cordless handset. For even more convenience, the Bluetooth® capability of a mobile phone can be used to make calls through the SIM Access Profile (SAP). Once automatic pairing is complete, the mobile phone's aerial is switched off to conserve battery charge and the phone operates via the

car aerial. Depending on the type of mobile phone, this gives access not only to the numbers on the SIM card, but also to the phone's internal memory. Also, depending on the phone, it can be controlled using PCM, the multifunction steering wheel or the voice control system, without it ever leaving your pocket.

In addition, the telephone module enables you to establish a Bluetooth® link with those mobile phones that only support the Handsfree Profile (HFP). In this case, the GSM connection is always established through the aerial of the mobile phone. PCM acts as a hands-free system and you can leave the mobile phone tucked away. Please refer to the note on page 159.

Stowed in the centre console, the telephone module has a cordless Bluetooth® active handset with display and keypad so that calls can be made and received privately in the presence of other passengers. However, the handset cannot be used for Bluetooth® links established using the Handsfree Profile (HFP).

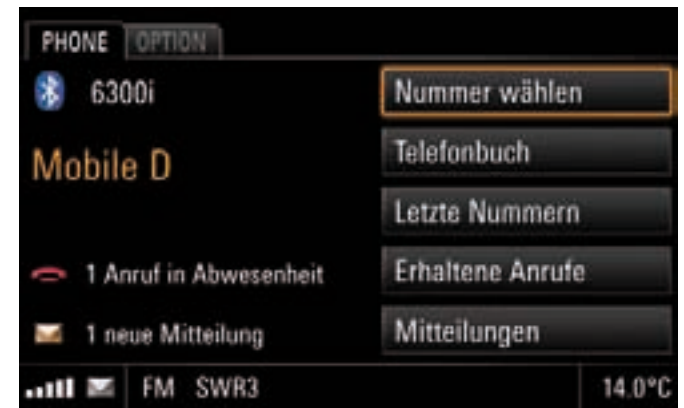



Universal audio interface

**Mobile phone preparation.**

To enable Bluetooth® connection for those mobile phones that only support Handsfree Profile (HFP), an optional mobile phone preparation is available. With HFP, PCM acts merely as a hands-free system and the mobile phone can remain tucked away. PCM can be used to control only the basic functions and the GSM connection is established through the mobile phone's aerial. Please refer to the note on page 159.

**Universal audio interface.**

Enhance your PCM with an optional connectivity package in the front centre console. An AUX interface and a USB port for connecting an iPod®.\* Your iPod®, or compatible MP3 player or USB stick connected to the USB interface, can be controlled using PCM. For more details, please consult your Porsche Centre.

**Porsche Rear Seat Entertainment.**

Porsche Rear Seat Entertainment is available as a factory-fitted option from Porsche Exclusive. The system comprises two display consoles, two multimedia players and two wireless infrared headphones. Not only is it compatible with all popular media formats (e.g. CD, DVD, MP3), it features user-friendly touchscreens and allows you to connect two separate, individually selectable AV sources, such as a games console or digital camera.

Each containing a swivelling 7-inch TFT screen, the screen consoles are finished in leather in the interior colour and mounted on the front seat backrests.



Porsche Rear Seat Entertainment

\* For information on compatibility with iPod® models, please contact your Porsche Centre.

**Your image of the world is also 360°.**

**BOSE® Surround Sound System.**

Can it be true that the passengers in a Porsche actually want to listen to music rather than the sound of the engine? We understand your scepticism, but we do have a compelling solution: the BOSE® Surround Sound System.

The BOSE® Surround Sound System is fitted as standard in the Panamera Turbo and optional across the rest of the Panamera model range.

The system comprises 9 amplifier channels with a total output of 585 watts. Its 14 loudspeakers and 200-watt active subwoofer deliver a balanced acoustic pattern and transform your Panamera into a concert hall.

In combination with Porsche Communication Management (PCM), the BOSE® Surround Sound System enables playback of audio DVDs and is thus able to make

full use of the impressive sound spectrum of 5.1 digital recordings. Of course, you can still play other audio sources such as CDs and MP3s. In stereo, or at the push of a button, in one of the virtual surround modes generated by BOSE® Centerpoint® 2.

The BOSE®-patented AudioPilot® Noise Compensation Technology uses a microphone to continuously measure the ambient noise inside the vehicle and adapts music playback automatically so that a consistent sound is maintained – whatever the driving conditions.

As an innovator in the field, BOSE® has used its considerable experience to adapt the system specifically to the passenger compartment of the Panamera. Thanks to signal processing technologies developed by BOSE® for the automotive industry, it has been possible to achieve optimum acoustics by tailoring the



system to suit the layout of the vehicle interior.

The result is a balanced, faithfully reproduced sound and captivating 360° acoustic experience delivered to all four seat positions. It's

just a pity that, as the driver, leaning back and closing your eyes is not an option.

**‘Made in Germany’ is a sign of quality.  
But, not just when it comes to sportscars.**

**The Burmester® High-End Surround Sound System.**



The sound developed by our research centre in Weissach is amplified by a sound from Berlin. We're talking about Burmester®, a bespoke manufacturer based in Berlin and one of the most respected premium audio manufacturers worldwide. The Burmester® High-End Surround Sound System is available as an option for all Panamera models.

The technologies behind the system are from the finest of Burmester's® premium home

audio systems. State-of-the-art and featured like this in a Porsche for the first time. The extravagance is uncompromising, the craftsmanship excellent, the sound phenomenal. The system owes its eminence to countless details, and one goal: perfection in sound.

As early as the Panamera concept phase, Porsche and Burmester® had already embarked on a close collaboration in order to determine the optimum installation locations for the special loudspeakers.

Never before has such a large and acoustically powerful total diaphragm surface area been used in a production vehicle and integrated to such perfection.

The system has 16 amplifier channels with a total output of more than 1,000 watts, 16 loudspeakers including an active subwoofer with 300-watt class D amplifier, a total diaphragm surface area of more than 2,400 cm², and a frequency response of 30 Hz to 20 kHz.

Conceptually, we have broken entirely new ground. Typically Porsche. Crossover technology has been carried over more or less unmodified from the home audio sector. Analogue and digital filters have been optimally defined for their new installation location and finely tuned after extensive in-car audio testing.

The tweeters are ribbon-based air motion transformers (AMT) that



have been designed specifically for the Panamera. For unmistakably fine, clear and undistorted high-frequency sound reproduction with excellent level stability. All loudspeaker housings are perfectly matched and deliver superior bass foundation, definition and impulse accuracy. As yet unequalled, the result is a nat-

ural and richly textured spatial sound. All of which is achieved, despite the system's remarkably low overall weight, thanks to intelligent Burmester® lightweight technology.

The elegantly pure design with galvanised surrounds and Burmester® logos on selected

loudspeakers make it clear that the appeal of the Burmester® High-End Surround Sound System is as much about the visual as it is the audio.

**You don't need us to reiterate the correlation between comfort and convenience.**

**Additional comfort and convenience features go hand in hand.**

**Climate control.**

Climate control, with zonal regulation in the front compartment, is standard in all models. Temperature and airflow volume, speed and direction can therefore be set individually for the driver and front passenger seat positions. An active carbon filter traps particles, pollen and odours and an automatic air-recirculation function

permanently monitors air quality, reduces humidity and switches from fresh to recirculated air when required. Even the glove compartment is actively cooled when necessary. With the ignition switched off, it is also possible to use the residual heat of the engine to heat the passenger compartment for up to 20 minutes.

Four-zone climate control is available for all models on request. With this option, the driver has access to separate controls for both seat positions in the rear. A control panel on the rear centre console also enables the rear passengers to select their own climate control settings for their respective seat position, independently of the settings in the front compartment.



Air vent in rear



Four-zone climate control in rear compartment



Air vents in centre console



Four-zone climate control

**Thermally and noise insulated glass.**

All Panamera models are equipped as standard with tinted heat-insulated glass and a grey top-tint on the windscreen. Available as an option is a thermally and noise insulated glass for all round more efficient reflection of infrared radiation. Enjoy an even more

pleasant climate and peace and quiet in the passenger compartment.

**Water-repellent side windows.**

The front side windows of the Panamera model range have been treated with a water-repellent coating so that not only water but

also dirt runs away more easily, thereby providing optimum visibility even in poor weather. (Note: surface finish requires occasional renewal depending on vehicle usage.)



Rain sensor

**Wiper system with rain sensor.**

The windscreen wiper system has two wiper speeds with an intermittent wipe. A rain sensor fitted as standard controls the wipers

automatically and with adjustable sensitivity. Three washer jets spray washer fluid uniformly onto the windscreen. A rear wiper is available as an option.

**HomeLink® (programmable garage door opener).**

As an option, it is possible to have a programmable garage door opener integrated into the overhead console. At the push of a button, it controls up to three different garage doors, lighting systems or alarm systems.

**ParkAssist.**

ParkAssist is standard in all Panamera models. With four inconspicuous sensors in the rear end, it audibly alerts the driver when detecting an obstacle behind the vehicle. An intermittent warning tone increases in rapidity as the obstacle is approached. Convenient and safe.

An enhanced version of ParkAssist, which includes six sensors in the front end, is fitted as standard in the Panamera Turbo and available

as an option in the other models. The audible alert is supplemented by a visual warning in the central display screen which provides a graphical representation of the vehicle's proximity to obstacles.

**Reversing camera.**

The optional reversing camera (only in conjunction with PCM and ParkAssist (front and rear)) facilitates precise reverse parking and manoeuvring and also assists in hitching a trailer. Help is provided in the form of the camera image and the dynamic, superimposed guidelines on the PCM screen, which illustrate the predicted course of the vehicle given the current position of the steering wheel.



Reversing camera



Reversing camera display in PCM





Cruise control

**Cruise control.**

Cruise control is fitted as standard for added driver comfort on long stretches of road. Cruise control operates in the 30 to 240 km/h (20–150 mph) speed range and is selected using a button on the steering column control stalk.

**Adaptive cruise control.**

Available as an option, this enhanced version of cruise control regulates the speed of your

vehicle in line with the speed of the vehicle in front. How does it work? A radar sensor inside the front centre air intake scans the road ahead up to a distance of 200 m. If you've selected a cruising speed but have begun to gain on the vehicle in front because it is driving more slowly, this is detected by the radar sensor.

The system now reduces the speed of your vehicle at a maximum rate of 3.5 m/s<sup>2</sup> by restricting the throttle or gently applying the brakes. This continues until the distance that you have preset

is maintained. Your vehicle will now follow the one in front at a reduced speed. If the other vehicle decelerates further, adaptive cruise control will continue to reduce your cruising speed – even down to a halt. For increased safety, the system also readies the brakes whenever a decreasing distance to the vehicle in front is detected. Adaptive cruise control and PSM interact to precharge the braking system. If heavier braking is required, the driver will have to intervene manually.

As soon as the road ahead clears, your vehicle will accelerate back up to the cruising speed originally set. To pull away after an automatic stop, simply press the control lever or depress the accelerator pedal.

**Slide/tilt sunroof.**

The slide/tilt sunroof is available as an option for all Panamera models. It is made from tinted toughened safety glass and features a manually adjustable sliding sunscreen and remote closing function.



Slide/tilt sunroof

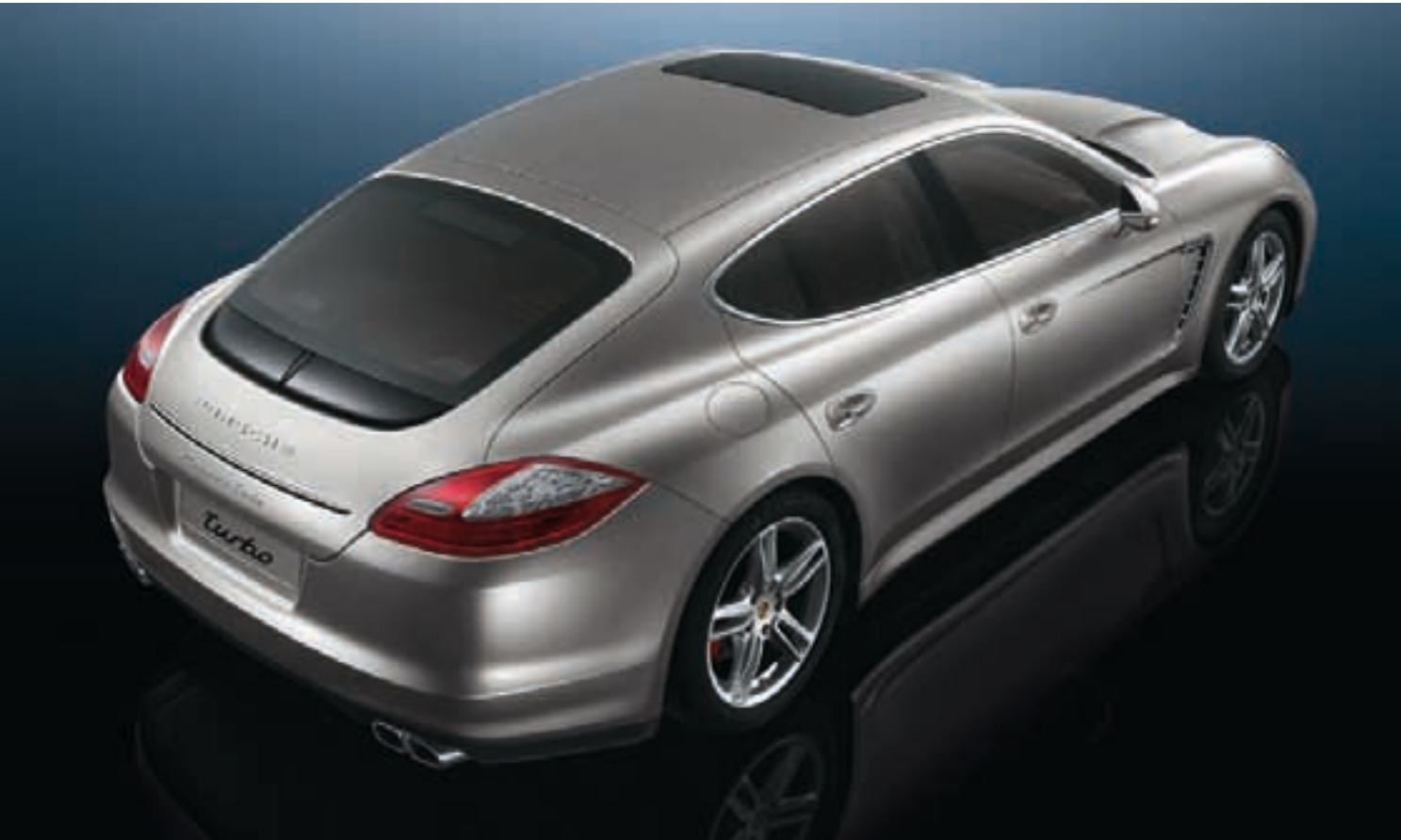

**Porsche Entry & Drive.**

Standard in the Panamera Turbo and optional for all other Panamera models, Porsche Entry & Drive is

recognisable from the chrome surfaces on the door handles. Fumbling for your key is now a thing of the past.

Why? As soon as you touch the door handle, the system automatically checks the encrypted access code on the key in your pocket. Once the key is validated,

the door unlocks. The engine can then be started and switched off using the electronic ignition switch.

To lock the vehicle, you simply press a button on the outside of the door handle. Porsche Entry & Drive then locks the vehicle and activates the engine immobiliser and steering column lock.

**Anti-theft protection.**

As standard, the entire Panamera model range is protected by an immobiliser with in-key transponder, two-stage locking and an alarm system with ultrasonic interior surveillance. The system secures all four doors, the bonnet, the rear lid, the passenger compartment, the ignition and any trailer that may be attached.

The immobiliser is activated and deactivated following validation of the key by the vehicle electronics. If the key is approved, the engine electronics authorise the engine to start.

For additional security, as soon as you remove the key, an electro-mechanical lock engages the steering column.

**In the back: lots of room.  
Right at the back: even more.**

**Luggage compartment.**



Four adults, luggage for four, one sports car. It really does work.

The luggage compartments in the Panamera, Panamera 4, Panamera S and Panamera 4S models have a capacity of 445 litres. In con-

junction with the BOSE® Surround Sound System or Burmester® High-End Surround Sound System, they offer 432 litres of luggage space, equal to the luggage capacity of the Panamera Turbo. Ample space for four suitcases

from the Porsche Design Driver's Selection range, for example. What makes the storage space special is that the four suitcases can be stowed in such a way that you can remove whichever one you choose with ease – no

reshuffling required. They can then be concealed using the retractable luggage compartment cover (fitted as standard) or the optional removable luggage compartment cover.

The key to this solution is the extraordinary height of the luggage compartment achieved through the special geometry of the rear lid and the large rear screen. The wide opening angle of the rear lid facilitates convenient loading.

A rarely encountered feature in this vehicle class is the fully or split-folding rear seats. In the cargo position, the available luggage capacity in the new Panamera and Panamera 4 models and in the Panamera S and 4S increases to 1,263 litres. In conjunction with the BOSE® Surround Sound System or Burmester® High-End Surround Sound System, the luggage compartment has a capacity of 1,250 litres, equal to that of the Panamera Turbo. The Panamera and Panamera S have a total payload of up to 605 kg, the Panamera 4 and 4S 580 kg and the Panamera Turbo 530 kg.



Luggage compartment with rear seat folded down



Luggage compartment holding two golf bags

Perhaps even more important than its capacity alone is the luggage compartment's versatility. The rear seats fold independently, allowing various transport configurations – even if one of the rear seats is occupied. Stowage nets in the side trim panels are provided for smaller items. A ski bag is

available as an option and, to accommodate it, the centre section between the rear seats folds separately.



**Luggage compartment with retractable luggage compartment cover.**  
Load: four large (L) suitcases.



**Luggage compartment with retractable luggage compartment cover and electric roll-up sunblind for behind the rear compartment.**  
Load: four medium (M) suitcases.



**Luggage compartment with removable luggage compartment cover.**  
Load: four medium (M) suitcases.



Retractable luggage compartment cover



Retractable luggage compartment cover with electric roll-up sunblind for behind the rear compartment



Removable luggage compartment cover



Removable luggage compartment cover with electric roll-up sunblind for behind the rear compartment

The contents of the luggage compartment can be concealed using the retractable luggage compartment cover provided as standard. It is also detachable and leaves enough space for four large (L) suitcases.

For extra protection, you could select the optional removable luggage compartment cover, which lifts up when the rear lid is opened, at which point it can be taken out. With the cover fitted, there is sufficient capacity for four medium (M) suitcases.

A roll-up sunblind offered as an option is compatible with either luggage cover. Controlled electrically, it lifts up behind the rear seats for extra privacy, leaving room for four medium (M) suitcases.



**Rear lid.**

The rear lid is made of lightweight aluminium. It unlocks in response to the remote control or the button on the handle. Top-hinged, it features a wide opening for comfortable loading and an electric soft closing function facilitates closing.

**Automatic rear lid.**

An automatic rear lid with customisable opening angle is available as an option. It closes automatically when the button on the rear lid itself is pressed and opens in response to the dedicated button on the key remote and in the interior.

**Roof transport systems.**

A luggage compartment capacity of 1,263 litres is plenty, you would have thought. You want more? No problem. An integrated roof rail system enables you to fit the optional roof transport system. It is then ready to hold any of the popular roof attachments available from Porsche Tequipment, e.g. ski holders and roof boxes. All load-carrying components are made of aluminium. Maximum payload: 75 kg.

**Towbar system.**

Pulling loads is effortless thanks to the optional electrically extending towbar system, which is invisible when retracted. The towbar has a maximum trailer load of 2,200 kg for braked trailers and 750 kg for unbraked trailers. Maximum noseweight: 100 kg.



Electrically extending towbar system

**Painting things in only the darkest colours isn't your style.**

**Colours.**

The extensive colour range of the Panamera models offers no fewer than 17 exterior colours. In total, there are two solid, ten metallic and five special colours to choose

from. Then there are seven interior colours and five two-tone equipment finishes, plus eight interior packages in aluminium, carbon or a selection of woods.



Panamera 4S

**Standard interior colours.  
Leatherette/leather/  
soft-touch paint.**



Black

**Carpet.**

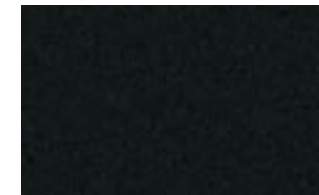

Black

**Rooflining.**

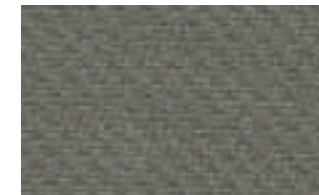

Platinum Grey<sup>1</sup>



Platinum Grey



Platinum Grey



Platinum Grey



Luxor Beige



Luxor Beige



Luxor Beige

**Standard colours: leather interior.**

**Leather/soft-touch paint.**



Black

**Carpet.**



Black

**Rooflining.**

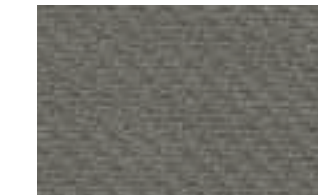

Platinum Grey<sup>1</sup>

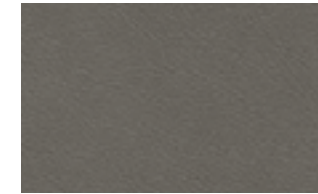

Platinum Grey



Platinum Grey



Platinum Grey

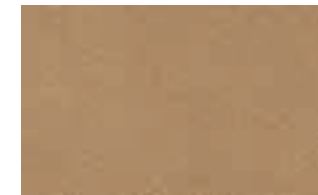

Luxor Beige



Luxor Beige



Luxor Beige



Yachting Blue



Yachting Blue

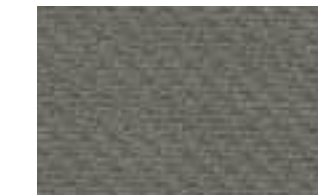

Platinum Grey

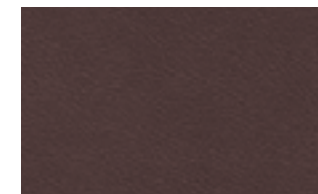

Marsala Red<sup>2</sup>



Marsala Red<sup>2</sup>

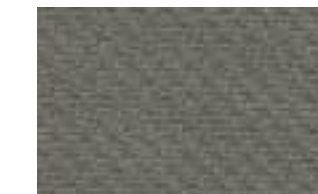

Platinum Grey

**Two-tone combinations: leather interior.**

**Leather/soft-touch paint.**

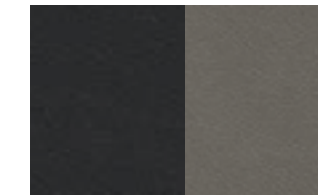

Black and Platinum Grey

**Carpet.**



Platinum Grey<sup>3</sup>

**Rooflining.**

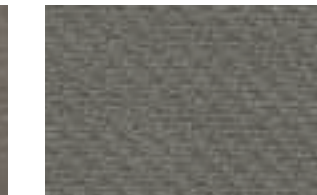

Platinum Grey<sup>1</sup>



Luxor Beige and Cream



Cream<sup>3</sup>



Cream



Yachting Blue and Cream

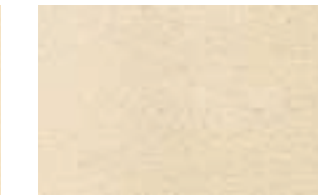

Cream<sup>3</sup>



Cream



Marsala Red and Cream<sup>2</sup>

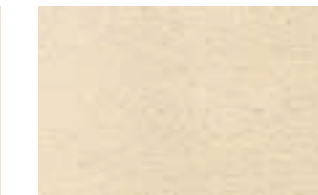

Cream<sup>3</sup>



Cream

**Natural leather interior.**

**Leather/soft-touch paint.**

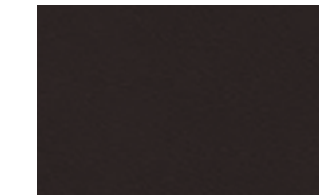

Espresso Natural Leather

**Carpet.**



Espresso

**Rooflining.**

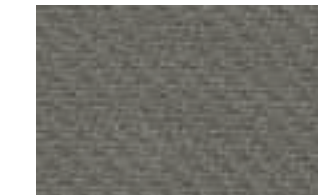

Platinum Grey



Cognac Natural Leather



Cognac



Cedar

**Two-tone combination: natural leather interior.**

**Leather/soft-touch paint.**



Cognac and Cedar Natural Leather

**Carpet.**



Cedar

**Rooflining.**



Cedar

<sup>1</sup> In Black when selected in conjunction with rooflining in Alcantara (standard in the Panamera Turbo).

<sup>2</sup> Available from 09/2010 at the earliest.

<sup>3</sup> With two-tone combinations, the luggage compartment is always in the darker of the two colours.

If you can't find the colour you'd like for your Panamera model, we can probably mix it for you.\* For more information, see the Porsche Exclusive Panamera catalogue.

Using the Porsche Car Configurator at [www.porsche.com](http://www.porsche.com), you can see how the available colours would look on your car, not only on the exterior, but in the interior, too.

\* Colours to sample available from 11/2010 at the earliest.



Panamera Turbo

**Solid exterior colours.**

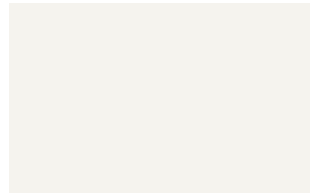

Carrara White



Black

**Metallic exterior colours.**

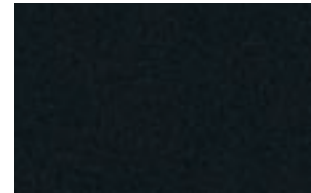

Basalt Black Metallic

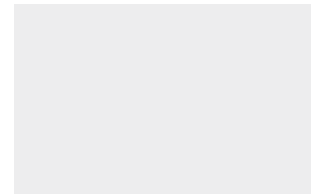

Platinum Silver Metallic



Carbon Grey Metallic



Ruby Red Metallic



Dark Blue Metallic



Yachting Blue Metallic



Jet Green Metallic



Topaz Brown Metallic

<sup>1</sup> Available from 09/2010 at the earliest.

**Special exterior colours.**



Luxor Beige Metallic<sup>1</sup>



Mahogany Metallic

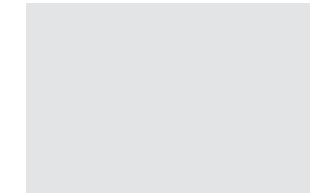

GT Silver Metallic



Aqua Blue Metallic

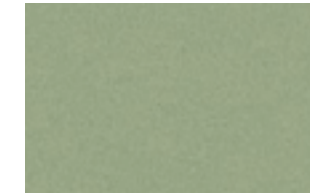

Crystal Green Metallic



Cognac Metallic



Amethyst Metallic

**Interior packages.  
Wood, carbon, aluminium.**

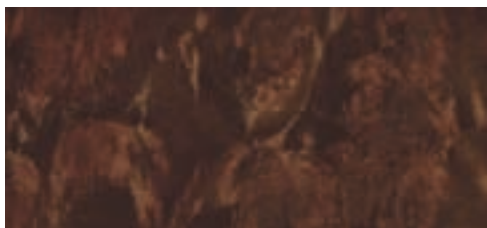

Walnut (standard in Panamera Turbo)<sup>1,2</sup>



Tineo<sup>1,2</sup>



Anthracite birch<sup>1,2</sup>

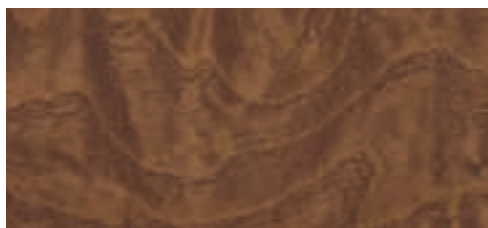

Natural olive<sup>2</sup>



Yachting Mahogany<sup>1,2</sup>



Brushed aluminium

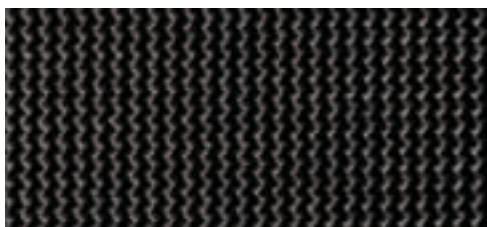

Carbon<sup>1</sup>



Black (high-gloss)

<sup>1</sup> Also available on steering wheel.

<sup>2</sup> Since wood is a natural product, there may be variations in colour and grain.

**Even if you set off without a particular destination in mind,  
the journey makes the trip worthwhile.**

**Personalisation.**

The standard specification of the Panamera model range may be second to none, but Porsche still gives you the opportunity to personalise your car to your own taste. There is a comprehensive range of individual items and equipment packages to choose from. For both the exterior and interior.

You will find more detailed information on the following pages and in the separate price list.

These are not the only ways to style your Panamera to your personal preference. How about personalisation of your car at the factory through Porsche Exclusive, or why not consider

our range of aftermarket accessories from Porsche Tequipment? You will find plenty of inspiring ideas in all the relevant catalogues and your Porsche Centre will be happy to advise you.







Slide/tilt sunroof



ParkAssist (front)



Rear wiper

The vehicles illustrated in the chapter on personalisation may include additional options not featured in this catalogue. For information on these options, please consult your Porsche Centre. For more information on the options featured in this catalogue, please refer to the separate price list.

Option	Panamera	Panamera 4	Panamera S	Panamera 4S	Panamera Turbo	I no.	Page
<b>Exterior.</b>							
• Metallic paint	○	○	○	○	●	Code	138
• Special colours	○	○	○	○	○	Code	139
• Colours to sample <sup>1</sup>	○	○	○	○	○	Code	
• SportDesign Package <sup>2</sup>	○	○	○	○	○	XAP	
• Exterior package Black (high-gloss) <sup>3</sup>	○	○	○	○	○	806	
• Porsche Entry & Drive	○	○	○	○	●	625	124
• Bi-Xenon headlights	●	●	●	●	●	601	81
• Bi-Xenon headlights including Porsche Dynamic Light System (PDLS)	○	○	–	–	–	603	83
• Porsche Dynamic Light System (PDLS)	–	–	○	○	●	603	83
• Automatically dimming mirrors	○	○	●	●	●	260/261	
• Deletion of model designation	A	A	A	A	A	498	
• ParkAssist (front and rear)	●	●	●	●	●	636	120
• ParkAssist (front and rear) with reversing camera	○	○	○	○	○	638	120
• Privacy glazing	○	○	○	○	○	866	103, 119
• Thermally and noise insulated glass	○	○	○	○	○	865	119
• Thermally and noise insulated glass including privacy glazing	○	○	○	○	○	864	119
• Electric slide/tilt glass sunroof	○	○	○	○	○	650	122, 142
• Rear wiper	○	○	○	○	○	425	142
• Roof transport system	○	○	○	○	○	549	131
• Automatic rear lid	○	○	○	○	○	867	131
• Electrically extending towbar system <sup>4</sup>	○	○	○	○	○	206	131

<sup>1</sup> Available from 11/2010 at the earliest.

<sup>2</sup> Available from 10/2010 at the earliest.

<sup>3</sup> Available from 09/2010 at the earliest.

<sup>4</sup> Maximum trailer load 2,200 kg (braked)/750 kg (unbraked), maximum noseweight 100 kg.

– not available    ○ Optional equipment    ● Standard equipment    A Available at no extra cost

Option	Panamera	Panamera 4	Panamera S	Panamera 4S	Panamera Turbo	I no.	Page
<b>Engine, transmission and chassis.</b>							
• Porsche Doppelkupplung (PDK) with Auto start/stop function	○	●	○	●	●	250	55
• Porsche Ceramic Composite Brake (PCCB)	○	○	○	○	○	450	86, 145
• Porsche Active Suspension Management (PASM)	○	○	●	●	●	475	66
• Adaptive air suspension with PASM	○	○	○	○	●	350/351	68
• Porsche Dynamic Chassis Control (PDCC) with Porsche Torque Vectoring Plus (PTV Plus)	○	○	○	○	○	715	70
• Servotronic	○	○	○	○	○	658	64
• Sport Chrono Package Plus	○	○	○	○	—	640	74
• Sport Chrono Package Turbo	—	—	—	—	○	640	76, 145
• Sports exhaust system	—	—	○	○	○	176	53, 145
• Sports tailpipes <sup>1</sup>	○	○	○	○	○	XLR	145
• Tyre Pressure Monitoring (TPM)	○	○	●	●	●	482	65
• Turbo Powerkit <sup>1</sup>	—	—	—	—	○	X80	

<sup>1</sup> Available from 09/2010 at the earliest.

The vehicles illustrated in the chapter on personalisation may include additional options not featured in this catalogue. For information on these options, please consult your Porsche Centre. For more information on the options featured in this catalogue, please refer to the separate price list.



Porsche Ceramic Composite Brake (PCCB)



Sport Chrono Package Turbo



Sports exhaust system



Sports tailpipes

— not available    ○ Optional equipment    ● Standard equipment    A Available at no extra cost



Panamera with 20-inch 911 Turbo II wheels



18-inch Panamera S wheel



19-inch Panamera Turbo wheel



19-inch Panamera Design wheel



20-inch RS Spyder Design wheel



20-inch 911 Turbo II wheel



20-inch Panamera Sport wheel

The vehicles illustrated in the chapter on personalisation may include additional options not featured in this catalogue. For information on these options, please consult your Porsche Centre. For more information on the options featured in this catalogue, please refer to the separate price list.

**Option**

**Wheels.**

Option	Panamera	Panamera 4	Panamera S	Panamera 4S	Panamera Turbo	I no.	Page
• 18-inch Panamera wheels	•	•	A	A	—		65
• 18-inch Panamera S wheels	○	○	•	•	—	413	65, 146
• 19-inch Panamera Turbo wheels	○	○	○	○	•	415	65, 146
• 19-inch Panamera Design wheels	○	○	○	○	○	416	146
• 20-inch RS Spyder Design wheels	○	○	○	○	○	417	146
• 20-inch 911 Turbo II wheels	○	○	○	○	○	418	146
• 20-inch Panamera Sport wheels	○	○	○	○	○	XRW	146
• 20-inch Panamera Sport wheels painted	○	○	○	○	○	XRX	
• 20-inch Panamera Sport wheels painted black	○	○	○	○	○	XRY	
• Wheel centres with full-colour Porsche Crest	○	○	○	○	○	446	9–12
• All-season tyres for 19-inch alloy wheels	A	A	A	A	A	415/416	
• All-season tyres for 19-inch alloy wheels (low-rolling resistance version) <sup>1</sup>	○	○	○	○	○	237	65

<sup>1</sup> Available from 10/2010 at the earliest.

— not available    ○ Optional equipment    • Standard equipment    A Available at no extra cost

Option	Panamera	Panamera 4	Panamera S	Panamera 4S	Panamera Turbo	I no.	Page
<b>Interior.</b>							
• Rear interior lighting package	○	○	○	○	○	630	102, 149
• HomeLink® (programmable garage door opener)	○	○	○	○	○	608	120
• Three-spoke multifunction steering wheel	○	○	○	○	○	844	96, 100
• Three-spoke sports steering wheel with gearshift paddles (only in conjunction with PDK) <sup>1</sup>	○	○	○	○	○	840	59
• Heated steering wheel	○	○	○	○	○	345	
• Adaptive cruise control	○	○	○	○	○	456	122, 149
• Driver memory package	○	○	○	○	–	537	104
• 14-way power seats with memory package	○	○	○	○	●	P80	104, 149
• Adaptive sports seats with memory package	○	○	○	○	○	P81	105
• 8-way power seats (rear)	○	○	○	○	○	834	106
• 8-way power seats (rear) with comfort headrests	○	○	○	○	○	834	106
• 8-way power seats (rear) (in conjunction with large centre console)	○	○	○	○	○	836	
• 8-way power seats (rear) with comfort headrests (in conjunction with large centre console)	○	○	○	○	○	836	150
• 8-way power seats (rear) (in conjunction with adaptive sports seats)	○	○	○	○	○	835	

<sup>1</sup> For Panamera S, Panamera 4S and Panamera Turbo, available from 09/2010 at the earliest.

The vehicles illustrated in the chapter on personalisation may include additional options not featured in this catalogue. For information on these options, please consult your Porsche Centre. For more information on the options featured in this catalogue, please refer to the separate price list.



Adaptive cruise control



14-way power seats with memory package



Rear interior lighting package

– not available    ○ Optional equipment    ● Standard equipment    A Available at no extra cost



Four-zone climate control



8-way power seats (rear) with seat ventilation and comfort headrests, large rear centre console

The vehicles illustrated in the chapter on personalisation may include additional options not featured in this catalogue. For information on these options, please consult your Porsche Centre. For more information on the options featured in this catalogue, please refer to the separate price list.

**Option**

**Interior.**

	Panamera	Panamera 4	Panamera S	Panamera 4S	Panamera Turbo	I no.	Page
• Side airbags in the rear compartment	○	○	○	○	●	565	90
• Heated seats (front)	●	●	●	●	–	342	106
• Heated seats (front and rear)	○	○	○	○	●	343	106
• Seat ventilation (front)	○	○	○	○	○	541	106
• Seat ventilation (front and rear)	○	○	○	○	○	542	106
• ISOFIX child seat mounting points on front passenger seat	○	○	○	○	○	899	104
• Removable luggage compartment cover	○	○	○	○	○	869	129
• Ski bag	○	○	○	○	○	213	127
• Floor mats	●	●	●	●	●	810	
• Four-zone climate control	○	○	○	○	○	576	118, 150
• Auxiliary heating <sup>1</sup>	○	○	○	○	○	851	
• Fire extinguisher	○	○	○	○	○	509	
• Large rear centre console	○	○	○	○	○	838	102, 150
• Cooling compartment in the rear	○	○	○	○	○	CZK	
• Electric roll-up sunblind for behind rear compartment	○	○	○	○	○	862	128
• Electric roll-up sunblind for rear side windows	○	○	○	○	○	861	
• Two fold-out cupholders above glove compartment	A	A	A	A	A	585	100

<sup>1</sup> Available from 09/2010 at the earliest.

– not available    ○ Optional equipment    ● Standard equipment    A Available at no extra cost

Option	Panamera	Panamera 4	Panamera S	Panamera 4S	Panamera Turbo	I no.	Page
<b>Interior: leather and natural leather.</b>							
• Leather interior			•	•	•	Code	156
– smooth-finish leather in standard colour	○	○	•	•	•	Code	153, 156
– in two-tone combination	○	○	○	○	○	Code	39
– in natural leather	○	○	○	○	○	Code	157
– in two-tone combination natural leather	○	○	○	○	○	Code	157
• Soft ruffled leather on seats (in conjunction with standard interior)	○	○	○	○	–	947	
• Soft ruffled leather on seats (in conjunction with leather interior)	○	○	○	○	○	982	
• Rooflining in Alcantara	○	○	○	○	•	594	103
• Porsche Crest embossed on headrests (front)	○	○	○	○	○	XYV	
• Porsche Crest embossed on headrests (front and rear)	○	○	○	○	○	XYW	
<b>Black (high-gloss) interior.</b>							
• Black (high-gloss) interior package	•	•	•	•	A	817	35
<b>Yachting Mahogany interior.</b>							
• Yachting Mahogany interior package	○	○	○	○	○	XZY	153
• Heated three-spoke multifunction steering wheel in Yachting Mahogany	○	○	○	○	○	XZZ	153
• Rooflining grab rails in Yachting Mahogany	○	○	○	○	○	CZH	



Interior in two-tone combination (Marsala Red and Cream), Carbon interior package and other optional equipment



Interior in two-tone combination (Yachting Blue and Cream), Yachting Mahogany interior package and other optional equipment

The vehicles illustrated in the chapter on personalisation may include additional options not featured in this catalogue. For information on these options, please consult your Porsche Centre. For more information on the options featured in this catalogue, please refer to the separate price list.

– not available    ○ Optional equipment    • Standard equipment    A Available at no extra cost

Option	Panamera	Panamera 4	Panamera S	Panamera 4S	Panamera Turbo	I no.	Page
<b>Walnut interior.</b>							
• Walnut interior package	○	○	○	○	●	821	157
• Heated three-spoke multifunction steering wheel in walnut	○	○	○	○	○	842	157
<b>Tineo interior.</b>							
• Tineo interior package	○	○	○	○	A	822	157
• Heated three-spoke multifunction steering wheel in tineo	○	○	○	○	○	849	157
<b>Anthracite birch interior.</b>							
• Anthracite birch interior package	○	○	○	○	A	823	155
• Heated three-spoke multifunction steering wheel in anthracite birch	○	○	○	○	○	848	155
<b>Natural olive interior.</b>							
• Natural olive interior package	○	○	○	○	○	824	155
<b>Carbon interior.</b>							
• Carbon interior package	○	○	○	○	○	819	103, 156
• Heated three-spoke multifunction steering wheel in carbon	○	○	○	○	○	845	156
<b>Aluminium interior.</b>							
• Brushed aluminium interior package	○	○	○	○	A	818	156
• PDK gear selector in aluminium	○	○	○	○	○	XYA	156
• Additional door sill guards in brushed aluminium	○	○	○	○	○	597	



Interior in two-tone combination (Yachting Blue and Cream), anthracite birch interior package with other optional equipment



Interior in two-tone combination (Luxor Beige and Cream), carbon interior package with other optional equipment



Interior in Luxor Beige, natural olive interior package with other optional equipment



Leather interior in Yachting Blue, brushed aluminium interior package with other optional equipment

The vehicles illustrated in the chapter on personalisation may include additional options not featured in this catalogue. For information on these options, please consult your Porsche Centre. For more information on the options featured in this catalogue, please refer to the separate price list.

– not available   ○ Optional equipment   ● Standard equipment   A Available at no extra cost



Interior in Platinum Grey, walnut interior package with other optional equipment



Interior in two-tone combination (Cognac and Cedar natural leather), tinea interior package with other optional equipment

**Option**

**Audio and communication options for vehicles with PCM.**

	Panamera	Panamera 4	Panamera S	Panamera 4S	Panamera Turbo	I no.	Page
• Porsche Communication Management (PCM) with navigation module <sup>3</sup>	•	•	•	•	•	P23	108
• Electronic logbook	○	○	○	○	○	641	110
• Voice control system	○	○	○	○	○	671	110
• TV tuner	○	○	○	○	○	676	110
• Telephone module with cordless handset <sup>1, 2</sup>	○	○	•	•	•	669	110, 159
• Additional charging cradle for active handset in the rear compartment	○	○	○	○	○	626	
• Mobile phone preparation <sup>1, 2</sup>	○	○	–	–	–	619	112
• Porsche Rear Seat Entertainment	○	○	○	○	○	CEU	112
• BOSE® Surround Sound System	○	○	○	○	•	680	114
• Burmester® High-End Surround Sound System	○	○	○	○	○	682	116
• Six-disc CD/DVD autochanger <sup>3</sup>	○	○	○	○	○	693	109
• Universal audio interface (AUX, USB, iPod®) <sup>4</sup>	○	○	○	○	○	870	112



Cordless handset



BOSE® Surround Sound System



Burmester® High-End Surround Sound System

<sup>1</sup> For information on compatible mobile phones, please contact your Porsche Centre or visit [www.porsche.com](http://www.porsche.com).

<sup>2</sup> Mobile phone preparation or telephone module with cordless handset in HFP mode: The use of a mobile phone inside a car may cause an increase in the interior electromagnetic field strength and, accordingly, in the electromagnetic radiation to which passengers are exposed (within the permissible limit values for mobile phones). The use of the telephone module for PCM via Bluetooth® SAP connection or with inserted SIM card helps to prevent exposure to electromagnetic radiation as only the car's external aerial is ever used.

<sup>3</sup> May be incompatible with some copy-protected CDs.

<sup>4</sup> For information on compatibility with iPod® models, please contact your Porsche Centre.

– not available   ○ Optional equipment   • Standard equipment   A Available at no extra cost

The vehicles illustrated in the chapter on personalisation may include additional options not featured in this catalogue. For information on these options, please consult your Porsche Centre. For more information on the options featured in this catalogue, please refer to the separate price list.

– not available   ○ Optional equipment   • Standard equipment   A Available at no extra cost





## Porsche Exclusive

### Let your car reflect your character.

With the range of options featured in this catalogue, you can make your Porsche even more special. Introducing Porsche Exclusive. Have your vehicle individually and exclusively tailored to your wishes even before it leaves the factory.

Aesthetically and technically, inside and outside, using fine materials and with customary Porsche quality.

Our overriding principle? That your car is uniquely handcrafted to your taste. You will find a wide range of design options in the separate Porsche Exclusive Panamera catalogue.

Either your Porsche Centre or the customer centre in Zuffenhausen (tel. +49 (0)711 911-25977 or email: [customercenter-exclusive@porsche.de](mailto:customercenter-exclusive@porsche.de)) will be happy to answer any questions about Porsche Exclusive that you may have. Please note that delivery times may be extended for certain Porsche Exclusive equipment.

## Factory collection

Come and collect your new Panamera model directly from the Porsche factory in Leipzig in which it was made, and enjoy a nearly five-hour experience in the fascinating world of Porsche. As part of a factory tour, you'll have an in-depth look behind the scenes. Then, it's on to a voyage of discovery through the customer centre. Here, we will introduce you not only to the history of Porsche but also to the latest vehicles in our range before accompanying you into the track control centre for a spectacular view of what's

going on out on the test track. A three-course meal in our restaurant is also included.

The highlight of your factory collection is still to come. An experienced Porsche instructor will explain all the finer details about your vehicle on the factory's own test track. And that's when your sporty experience really begins, because now you can take your seat behind the wheel of one of our Panamera models. Follow the ideal line along our on-road circuit. Race down the

straights, steer hard into the hairpins and weave your way through the chicanes – always under the expert supervision of one of our motorsport professionals, who will take this opportunity to explain the relevant controls in the vehicle and teach you some useful tips and tricks.

The end of your experience day, which, incidentally, you can share with up to two companions, culminates in the handover of your vehicle. Fully fuelled, and ready to go, of course.





### Porsche Centres

Your Porsche Centre can assist you with every aspect of purchasing and owning your Porsche. You will also find a wide range of products and services, including genuine Porsche parts and accessories.

### Porsche Assistance

Enjoy peace of mind with our exclusive breakdown and accident recovery service. Membership is free when you buy a new Porsche.

### Porsche Financial Services

Our innovative suite of financial services is specially tailored to the needs of Porsche owners. Products range from attractive finance and leasing options to vehicle insurance and the Porsche Card.

### Porsche Exclusive

Realise your vision of the perfect Porsche with our factory customisation programme. From styling enhancements to performance upgrades, all modifications are uniquely handcrafted for your Porsche.

### Porsche Tequipment

Personalise your Porsche at any time after purchase with the Tequipment range of approved accessories. Designed exclusively for your car, every product is fully guaranteed.

### Porsche Design Driver's Selection

With products ranging from fashion and accessories to tailored luggage, this unique collection combines quality and style with everyday practicality.

## Service

### Porsche Used Car Programme

Porsche Approved is the simple way to find the perfect pre-owned Porsche, anywhere in the world. Every car is rigorously tested and comes with a comprehensive vehicle warranty.

### Porsche Classic

Your specialist source for genuine Porsche parts and technical documentation as well as servicing, repair and restoration for all types of classic Porsche. Find out more at [www.porsche.com/classic](http://www.porsche.com/classic).

### Christophorus

Our bi-monthly magazine for Porsche owners has news, interviews and a wide variety of features from throughout the world of Porsche.

### Porsche Clubs

Since the first Porsche Club was founded in 1952, their number has grown to 613 with a total of 120,000 members worldwide. To find out more, call +49 (0)711 911-78307 or go to [www.porsche.com](http://www.porsche.com).

### Porsche Driving Experience

**1. Porsche Travel Club.** Exclusive driving holidays and incentive ideas combining luxury and adventure, worldwide. To find out more, call +49 (0)711 911-78155. E-mail: [travel.club@porsche.de](mailto:travel.club@porsche.de)

### 2. Porsche Sport Driving School.

Develop your skill and explore your Porsche with the Porsche Sport Driving School. To learn about events at some of the world's most famous racing venues, call +49 (0)711 911-78683. E-mail: [sportdrivingschool@porsche.de](mailto:sportdrivingschool@porsche.de)



### Porsche Online

For all the latest news and information from Porsche, go to [www.porsche.com](http://www.porsche.com).



Ask your Porsche Centre for the latest brochures from Porsche Exclusive, Porsche Tequipment, Porsche Design Driver's Selection and the Porsche Driving Experience.

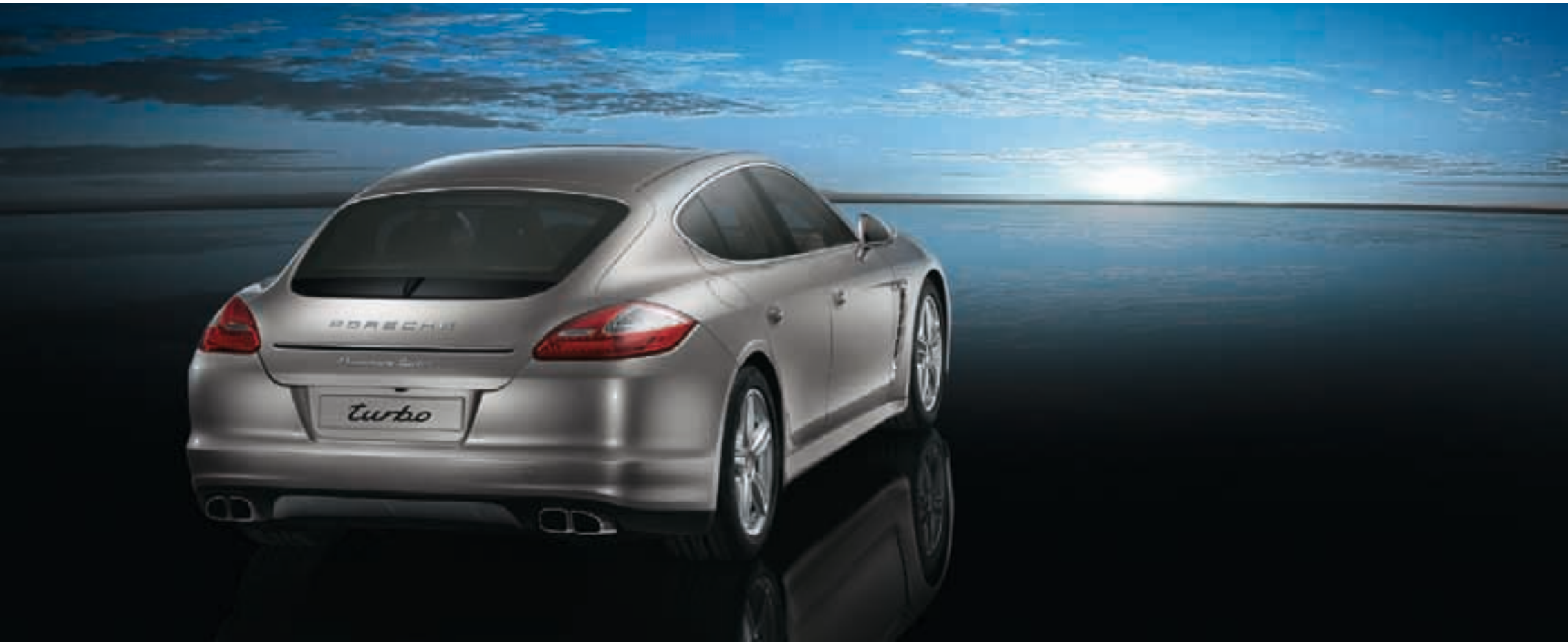

## Summary

Four doors. Four seats. Sportscar technology for four. With luggage and without compromise. This is our contribution to the premium class. Or more precisely, to driving in the premium class. We've discovered that some extra sporty dynamics wouldn't go amiss. The Panamera.

	Panamera	Panamera 4
<b>Engine</b>		
Cylinders	6	6
Displacement	3,605 cm <sup>3</sup>	3,605 cm <sup>3</sup>
Max. power (DIN) at rpm	220 kW (300 hp) 6,200	220 kW (300 hp) 6,200
Max. torque at rpm	400 Nm 3,750	400 Nm 3,750
Compression ratio	12.5:1	12.5:1
<b>Transmission</b>		
Layout	Rear-wheel drive	All-wheel drive
Manual gearbox (6-speed)	Standard	–
PDK (7-speed)	Optional	Standard
<b>Chassis</b>		
Front axle	Fully independent large-format double wishbone suspension	Fully independent large-format double wishbone suspension
Rear axle	Fully independent multi-link suspension	Fully independent multi-link suspension
Steering	Power-assisted (hydraulic)	Power-assisted (hydraulic)
Brakes	Six-piston aluminium monobloc fixed brake calipers at front, four-piston aluminium monobloc brakes at rear, internally vented discs, ABS	Six-piston aluminium monobloc fixed brake calipers at front, four-piston aluminium monobloc brakes at rear, internally vented discs, ABS
Wheels	Front: 8 J x 18 ET 59 Rear: 9 J x 18 ET 53	Front: 8 J x 18 ET 59 Rear: 9 J x 18 ET 53
Tyres	Front: 245/50 ZR 18 Rear: 275/45 ZR 18	Front: 245/50 ZR 18 Rear: 275/45 ZR 18
<b>Weights</b>		
	Manual/PDK	PDK
Unladen weight (DIN)	1,730 kg/1,760 kg	1,820 kg
Unladen weight (EC) <sup>1</sup>	1,805 kg/1,835 kg	1,895 kg
Permissible gross weight	2,335 kg/2,365 kg	2,400 kg
Max. payload	605 kg/605 kg	580 kg

<sup>1</sup> Weight is calculated in accordance with the relevant EC Directives and is valid for vehicles with standard specification only. Optional equipment increases this figure. The figure given includes 68 kg for the driver and 7 kg for luggage.

Panamera S	Panamera 4S	Panamera Turbo
8	8	8
4,806 cm <sup>3</sup>	4,806 cm <sup>3</sup>	4,806 cm <sup>3</sup>
294 kW (400 hp) 6,500	294 kW (400 hp) 6,500	368 kW (500 hp) 6,000
500 Nm 3,500–5,000	500 Nm 3,500–5,000	700 Nm 2,250–4,500
12.5:1	12.5:1	10.5:1
<b>Transmission</b>		
Rear-wheel drive	All-wheel drive	All-wheel drive
Standard	–	–
Optional	Standard	Standard
<b>Chassis</b>		
Fully independent large-format double wishbone suspension	Fully independent large-format double wishbone suspension	Fully independent large-format double wishbone suspension
Fully independent multi-link suspension	Fully independent multi-link suspension	Fully independent multi-link suspension
Power-assisted (hydraulic)	Power-assisted (hydraulic)	Power-assisted (hydraulic)
Six-piston aluminium monobloc fixed brake calipers at front, four-piston aluminium monobloc brakes at rear, internally vented discs, ABS	Six-piston aluminium monobloc fixed brake calipers at front, four-piston aluminium monobloc brakes at rear, internally vented discs, ABS	Six-piston aluminium monobloc fixed brake calipers at front, four-piston aluminium monobloc brakes at rear, internally vented discs, ABS
Front: 8 J x 18 ET 59 Rear: 9 J x 18 ET 53	Front: 8 J x 18 ET 59 Rear: 9 J x 18 ET 53	Front: 9 J x 19 ET 60 Rear: 10 J x 19 ET 61
Front: 245/50 ZR 18 Rear: 275/45 ZR 18	Front: 245/50 ZR 18 Rear: 275/45 ZR 18	Front: 255/45 ZR 19 Rear: 285/40 ZR 19
<b>Weights</b>		
Manual/PDK	PDK	PDK
1,770 kg/1,800 kg	1,860 kg	1,970 kg
1,845 kg/1,875 kg	1,935 kg	2,045 kg
2,375 kg/2,405 kg	2,440 kg	2,500 kg
605 kg/605 kg	580 kg	530 kg

Some items of equipment featured on or in the vehicles in this catalogue are available as extra-cost options only. All information regarding construction, features, design, performance, dimensions, weights, fuel consumption and running costs was correct to the best of our knowledge at the time of going to print. Subject to change without notice.

<b>Performance</b>	<b>Panamera</b>	<b>Panamera 4</b>
	Manual/PDK	PDK
Top speed	261 km/h (162 mph)/ 259 km/h (161 mph)	257 km/h (160 mph)
0–100 km/h (0-62 mph)	6.8 secs/6.3 secs	6.1 secs
0–100 km/h (0-62 mph) with Sport Chrono Package	6.8 secs/6.1 secs	5.9 secs
Flexibility (80–120 km/h (50–75 mph) in 5th gear)	8.4 secs/–	–
In-gear acceleration (80–120 km/h) (50–75 mph)	–/4.3 secs	4.4 secs
<b>Fuel consumption/emissions<sup>1</sup></b>	Manual/PDK	PDK
Urban in l/100 km	16.4 (16.1 <sup>2</sup> )/12.7 (12.5 <sup>2</sup> )	12.8 (12.7 <sup>2</sup> )
Urban in mpg	17.2 (17.5 <sup>2</sup> )/22.2 (22.6 <sup>2</sup> )	22.1 (22.2 <sup>2</sup> )
Extra urban in l/100 km	7.8 (7.6 <sup>2</sup> )/6.9 (6.8 <sup>2</sup> )	7.2 (6.9 <sup>2</sup> )
Extra urban in mpg	36.2 (37.2 <sup>2</sup> )/40.9 (41.5 <sup>2</sup> )	39.2 (40.9 <sup>2</sup> )
Combined in l/100 km	11.3 (11.1 <sup>2</sup> )/9.3 (9.1 <sup>2</sup> )	9.6 (9.4 <sup>2</sup> )
Combined in mpg	25.0 (25.4 <sup>2</sup> )/30.4 (31.0 <sup>2</sup> )	29.4 (30.1 <sup>2</sup> )
CO <sub>2</sub> emissions g/km	265 (260 <sup>2</sup> )/218 (213 <sup>2</sup> )	225 (220 <sup>2</sup> )
<b>Dimensions</b>		
Length	4,970 mm	4,970 mm
Width (including exterior mirrors)	1,931 mm (2,114 mm)	1,931 mm (2,114 mm)
Height	1,418 mm	1,418 mm
Wheelbase	2,920 mm	2,920 mm
Luggage compartment volume	445 litres	445 litres
with rear seats folded down	1,263 litres	1,263 litres
Fuel capacity/reserve	80 litres/15 litres	80 litres/15 litres

<b>Panamera S</b>	<b>Panamera 4S</b>	<b>Panamera Turbo</b>
	Manual/PDK	PDK
285 km/h (177 mph)/ 283 km/h (176 mph)	282 km/h (175 mph)	303 km/h (188 mph)
5.6 secs/5.4 secs	5.0 secs	4.2 secs
5.6 secs/5.2 secs	4.8 secs	4.0 secs
7.0 secs/–	–	–
–/3.2 secs	3.3 secs	2.7 secs
<b>Manual/PDK</b>	<b>PDK</b>	<b>PDK</b>
18.8 (18.5 <sup>2</sup> )/15.5 (15.2 <sup>2</sup> )	16.0 (15.7 <sup>2</sup> )	17.0 (16.7 <sup>2</sup> )
15.0 (15.3 <sup>2</sup> )/18.2 (18.6 <sup>2</sup> )	17.7 (18.0 <sup>2</sup> )	16.6 (16.9 <sup>2</sup> )
8.9 (8.7 <sup>2</sup> )/7.6 (7.5 <sup>2</sup> )	7.9 (7.7 <sup>2</sup> )	8.4 (8.2 <sup>2</sup> )
31.7 (32.5 <sup>2</sup> )/37.2 (37.7 <sup>2</sup> )	35.8 (36.7 <sup>2</sup> )	33.6 (34.4 <sup>2</sup> )
12.5 (12.3 <sup>2</sup> )/10.5 (10.3 <sup>2</sup> )	10.8 (10.6 <sup>2</sup> )	11.5 (11.3 <sup>2</sup> )
22.6 (23.0 <sup>2</sup> )/26.9 (27.4 <sup>2</sup> )	26.2 (26.6 <sup>2</sup> )	24.6 (25.0 <sup>2</sup> )
293 (288 <sup>2</sup> )/247 (242 <sup>2</sup> )	254 (249 <sup>2</sup> )	270 (265 <sup>2</sup> )
4,970 mm	4,970 mm	4,970 mm
1,931 mm (2,114 mm)	1,931 mm (2,114 mm)	1,931 mm (2,114 mm)
1,418 mm	1,418 mm	1,418 mm
2,920 mm	2,920 mm	2,920 mm
445 litres	445 litres	432 litres
1,263 litres	1,263 litres	1,250 litres
80 litres/15 litres	100 litres/15 litres	100 litres/15 litres

<sup>1</sup> The latest Porsche models are designed to operate on fuels with an ethanol content of up to 10%. Data determined for standard specification and in the NEDC (New European Driving Cycle) in accordance with the Euro 5 (715/2007/EC and 692/2008/EC) measurement method. The figures do not refer to an individual vehicle nor do they constitute part of the offer. They are intended solely as a means of comparing different types of vehicle. You can obtain further information about individual vehicles from your Porsche Centre.

<sup>2</sup> In conjunction with 19-inch all-season tyres (low-rolling resistance version).

Some items of equipment featured on or in the vehicles in this catalogue are available as extra-cost options only. All information regarding construction, features, design, performance, dimensions, weights, fuel consumption and running costs was correct to the best of our knowledge at the time of going to print. Subject to change without notice.

**Term** **Page**

<b>A</b>		<b>E</b>		<b>L</b>	
Active bonnet system	89	Electronic engine management	42	Launch Control	76
Adaptive air suspension	68	Emission control	93	Levelling system	68
Adaptive cruise control	122	Engineered safety design	88	Light-alloy construction	89
Airbags	90	Engines	42	Lighting concept	80
All-wheel drive	60	Environment	92	Lights	80
Anti-theft protection	125	Exhaust system	53	Loading options	127
Audio systems	108, 158	Exhaust turbocharging	52	Luggage compartment	126
Auto start/stop function	50	Exterior	22, 138	<b>M</b>	
Axle concept	64			Manual gearbox	54
<b>B</b>		<b>F</b>		<b>MP3</b>	
BOSE® Surround Sound System		Factory collection	161		109, 112
Sound System	114	Fuel system	96	Multifunction steering wheel	58, 100
Brakes	84	<b>G</b>		<b>N</b>	
Burmester® High-End Surround Sound System	116	GPS navigation system	110	Navigation	110
<b>C</b>		<b>H</b>		<b>O</b>	
CD/DVD autochanger	108, 109	Headlight cleaning system	81	Oil supply	42
Ceramic brake	86	Headlights	80	On-board computer	104
Chassis	62	Height adjustment	68	<b>P</b>	
Child seats	104, 106	HomeLink® (programmable garage door opener)	120	ParkAssist	120
Climate control	118			Parking brake, electric	85
Colours	132	<b>I</b>		Payload	127
Cruise control	122	Interior	26, 100, 133	Personalisation	141
<b>D</b>		Interior lighting	102	Porsche Active Suspension Management (PASM)	66
Direct fuel injection (DFI)	51	Interior packages	140, 152		

Porsche Ceramic Composite Brake (PCCB)	86	Recycling	94	<b>V</b>	
Porsche Communication Management (PCM)	108	Reversing camera	121	V6 engines	44
Porsche Doppelkupplung (PDK)	55	Roll-up sunblind	103, 129	V8 engines	47
Porsche Dynamic Chassis Control (PDCC)	70	Roof transport systems	131	VarioCam Plus	52
Porsche Dynamic Light System (PDLS)	83			Voice control system	110
Porsche Entry & Drive	124	<b>S</b>		<b>W</b>	
Porsche Rear Seat Entertainment	112	Safety	80	Water-repellent side windows	119
Porsche Side Impact Protection System (POSIP)	90	Seats	104	Wheels	65, 146
Porsche Stability Management (PSM)	72	Servicing	97		
Porsche Torque Vectoring Plus (PTV Plus)	70	Servotronic	64		
Porsche Traction Management (PTM)	60	Slide/tilt sunroof	123		
Power output	44, 47, 48	SPORT button	50, 74		
Privacy glazing	103	Sport Chrono Packages	74		
<b>R</b>		Sports exhaust system	53, 145		
Radio	108	Steering	64		
Rain sensor	120	<b>T</b>			
Rear lid	131	Technical data	166		
		Thermally insulated glass	119		
		Touchscreen	108		
		Towbar system	131		
		Transmission	54		
		TV tuner	110		
		Tyre Pressure Monitoring (TPM)	65		
		<b>U</b>			
		Universal audio interface	112		



