

SAAB 900



SAAB 900 TURBO



NOTHING PERFORMS LIKE A SAAB.

The 1980 Saab 900's are among the most exciting and sophisticated automobiles available in the world today. They are technically advanced, impeccably engineered and fun and safe to drive.

All 900's are exquisitely road-worthy, comfortable and well-

equipped. And since no two drivers' taste for excitement is alike, there are four great 900's to choose from: the sensational turbo-driven Turbos, the plush GLE, the sporty EMS, and the practical GLi. Each one has its own unique combination of features.



SAAB 900 TURBO, 5-DOOR.

The high point of the 900 series. The height of performance and luxury. The Saab Turbo engine delivers remarkable power in everyday driving situations. The plush velour interior seats five in style and comfort. Air conditioning and power steering are standard.



SAAB 900 TURBO, 3-DOOR.

The same sparkling acceleration and performance of its five door brother. The styling both inside and out is designed for the driver who's after advanced and sporty design. Power steering is standard.



SAAB 900 GLE, 5-DOOR.

The power plant is the famous Saab overhead cam, fuel-injected engine. Inside you'll find the same dignity and trim appointments of the 5-door Turbo.



SAAB 900 EMS, 3-DOOR.

The sporty 900. The EMS combines the gutsy performance of our overhead cam, fuel-injection with the dashing interior of the Turbo 3-door. And like all Saab 900's the EMS has road gripping front wheel drive.



SAAB 900 GLi, 3-DOOR.

The GLi is powered by a fuel injected two litre, overhead cam engine. As with all other 900 models, the GLi has a luggage capacity which is easily adjustable between 13.5 and 53.0 cubic feet.

A SAAB 900 CAN BE WHATEVER YOU WANT IT TO BE.

1. Sun roof. The Saab sun roof is made of steel. It slides silent and tight, and adjusts easily with one hand. It's padded and lined.

Metallic paint. The lustre of our optional metallic paint will give your Saab a jewel-like quality.

2. 4-speed gearbox. A sturdy, race proven manual transmission. It allows the driver to squeeze the most from Saab power plants. Shifting is smooth and precise.

3. 5-speed manual gearbox. A new transmission for our Turbo cars. In fifth gear you can hardly hear the engine. And fuel economy is improved too, since the engine speed is reduced 13% in fifth gear.



1.



2.



3.



4.



5.



6.

4. Automatic transmission. Our silent, efficient three speed automatic makes driving a 900 relaxed and more comfortable than ever.

5. Air conditioning. All 900's are available with either factory or dealer installed fully integrated air conditioning system depending on model.

6. Power steering. Our rack and pinion power steering is one of the best in the industry. It takes about 50% of the effort out of parking, but retains the solid Saab feel of the road.

ONE THING THE EXPERTS CAN AGREE ON: NOTHING PERFORMS LIKE A SAAB.

"Exceptional road car. Quiet, fast, stable, comfortable. This is the way to tour. Probably one of the best 4 or 5 doors on the market."

Road & Track

"... the car can hold its own against such sophisticated competitors as the Audi 5000, BMW 528i and Mercedes 280E."

Autoweek

"... the back half of the car can be converted from a drawing room into a cargo area big enough to swallow a Subaru."

Car and Driver

"The best part of the Turbo is the two-litre four-cylinder engine, which acts like a V-8."

Car and Driver

"... it's a car that can be flung around corners and hustled down straightaways with the best of them."

Road & Track

"Perhaps BMW and Mercedes will build a similar state-of-the-art car in four or five years ..."

Autoweek

"Along with the spirited performance and exhilarating handling characteristics, the 5-door also gives everyone on board a pleasant, smooth ride."

Road & Track

SAAB 900

SAAB 900 TURBO









A DRIVING ENVIRONMENT IN A CLASS BY ITSELF.

When you're inside a Saab 900 you're in another world. The seating is ample and sumptuous. Space is abundant. The ride is virtually silent. And as a finishing touch, even the air around you hasn't been overlooked. Saab engineers have developed an ingenious fully integrated heating and ventilation system.

The secret lies in a special air filter that prevents virtually all small particles, such as pollen and dust, from entering the car. We hardly have to point out what this means to every motorist, not to mention those who suffer from allergies or asthma.



Saab seating. The height of comfort. The new front seats of the Saab 900 are designed to meet the most stringent demands for both safety and comfort. The seat and backrest give superb support from the knees right up to the neck. The lumbar support is elastic and needs no manual re-setting. The sides of the backrest are deeper and distinctively contoured. The front seats

are fully reclining. The frame of the backrest has sturdy tubular members and two reinforcing plates. The top is fitted with an adjustable head restraint which also serves as a headrest. The driver's seat is electrically heated on the EMS, GLE and Turbo models. And so is the front passenger's on the GLE and 5-door Turbo. The rear of the Saab 900 easily accommodates three people. And the headroom is practically the same front and rear. And since there's no bulky drive shaft (thanks to front wheel drive), there's lots of legroom, even for the passenger in the center of the back seat.

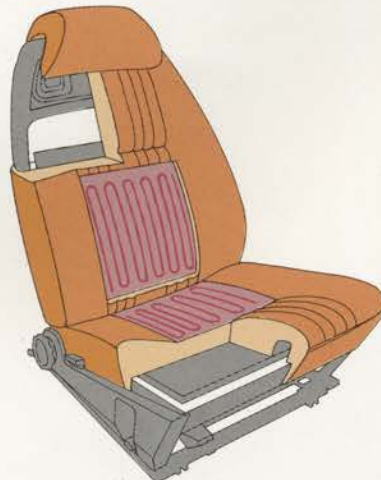

The driver's seat on the EMS, GLE and Turbo is equipped with a thermostatically controlled electric heating element. If the temperature of the seat falls below 54 degrees F, the heat comes on automatically when the ignition key is turned. When the seat temperature rises to 82 degrees F, the heat is automatically turned off.

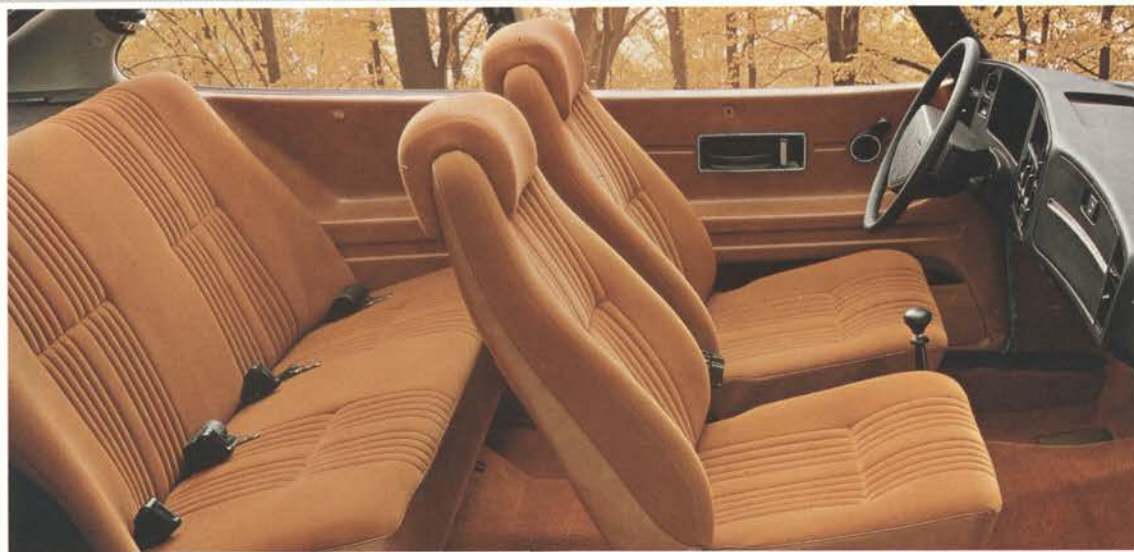

1. The spacious, airy interior of the GLi 3-door model features a matched range of colors and beautifully designed seat upholstery in soft velour.

2. Note the special detailing of the upholstery in the EMS and Turbo 3-door. There's also a folding center armrest in the back seat.

3. Passengers in the back seat have the same sense of space and comfort as those in the front.

4. Saab has introduced a unique air filter that virtually eliminates pollen and dust particles from entering the interior. It's easily accessible under the hood and simple to replace. (Not available on cars equipped with air conditioning.)



3.

4.



SAAB 900 EMS



PERFORMANCE. YOU'VE COME TO THE RIGHT PLACE.

Over the years, Saabs have carved out an excellent reputation for their stirring performance. Few cars can match Saab's combination of power, handling and comfort.

The Saab 900's are the logical extension of that tradition. They're built to withstand the hardships of rough terrain, blustery winds, sharp turns and steep hills. The key ingredient behind the 900's remarkable performance is consis-



changes significantly. You will gain more confidence in a Saab 900 than you've ever had in a car before. Saab's formula for a great car has always been simple: Engine in the front, front wheel drive, lightweight rear axle and a body with low wind resistance. In the 900 these principles have been refined and honed to near perfection. That is why they are a major advance in performance vehicles.

tency. You know exactly what to expect from a Saab 900; whether you're cornering, accelerating or braking. The road behavior never

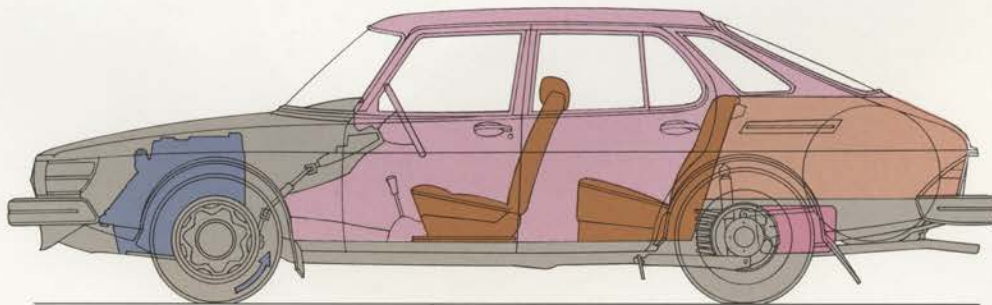

Front engine, front wheel drive, rack and pinion steering. The front wheels support almost 60% of the weight for outstanding

road contact. The fuel tank is well forward and below the luggage compartment where it is protected by the rear axle and wheels.

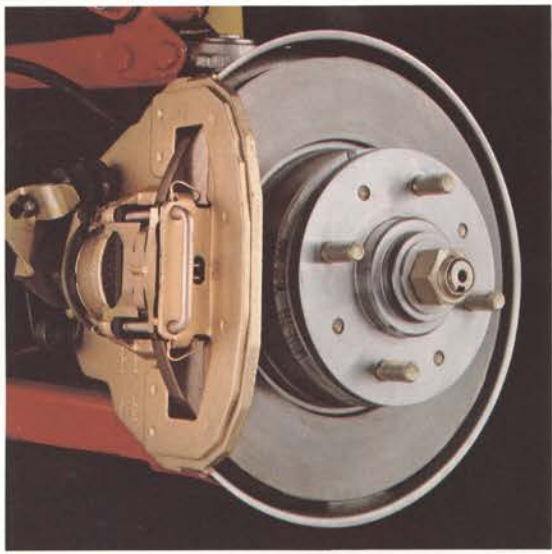

1.



2.



3.

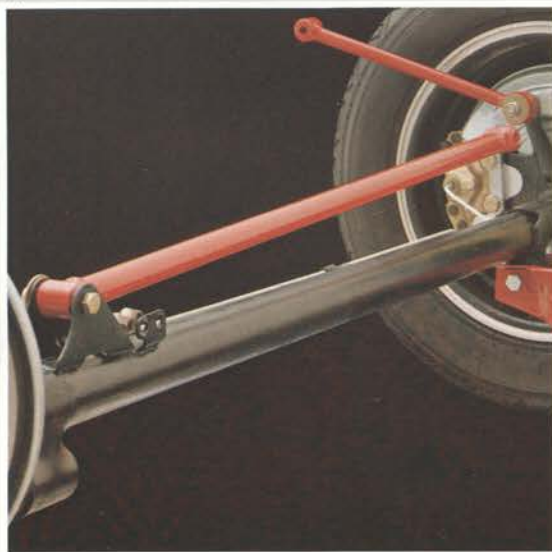

4.

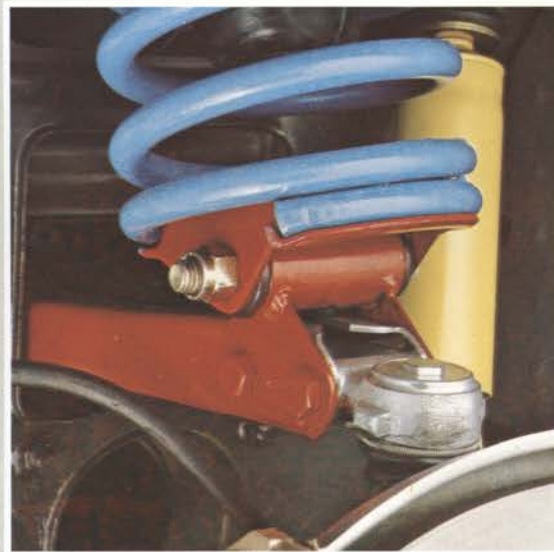

5.

1. Self-adjusting power-assisted disc brakes on all four wheels. For optimum safety, the system consists of two diagonally split circuits. The most dependable type of brake system available.

2. For the 900 EMS, GLE and Turbo models gas pressurized shock absorbers. They give the road holding character of a sports car.

3. For the sports minded there's the EMS with its sports steering ratio, tach, aluminum alloy wheels and low profile tires.

4. The rear axle of the Saab 900 is a straight, one piece, light-weight unit. This helps to assure that the wheels remain in good contact with the road for maximum cornering and braking traction.

5. The front springs are pivot mounted. This means that the tendency to buckle during compression is eliminated, and since the spring travel is relatively long, the wheels can better retain their grip of the road. Even over potholes, frost heaves and road dips.

SAAB 900 GLE





THE PERFECT DRIVER ENVIRONMENT.

A relaxed, comfortable driver is a better driver. With that premise firmly in mind, Saab engineers set out to create a setting for the driver where all the elements for controlling the vehicle were located and arranged in a precise logical pattern. But before even our draftsmen put pen to paper, we consulted psychologists and ergonomic specialists, and considered our own wealth of experience. Man's reach and senses were carefully studied. Particular attention was paid to the length of arms, legs and trunks



of a wide variety of drivers. We established the ideal relationships between instrumentation, steering wheel, windshield, and hood outline. The conclusions from these

studies formed the basis for the design and location of the controls. All instruments and indicators are located at a high level, within a person's central field of vision. The driver's attention is never drawn away from the road. All this is rounded off by the Saab driver's seat, recognized as one of the most comfortable and anatomically correct in the world. It's equipped with a new adjustable head restraint and headrest combination. And it's electrically heated on the EMS, GLE and Turbo models.

Excellent visibility and location of controls maximize the driver's ability to react. Since everything is at eye level and within easy reach you can concentrate on the road.

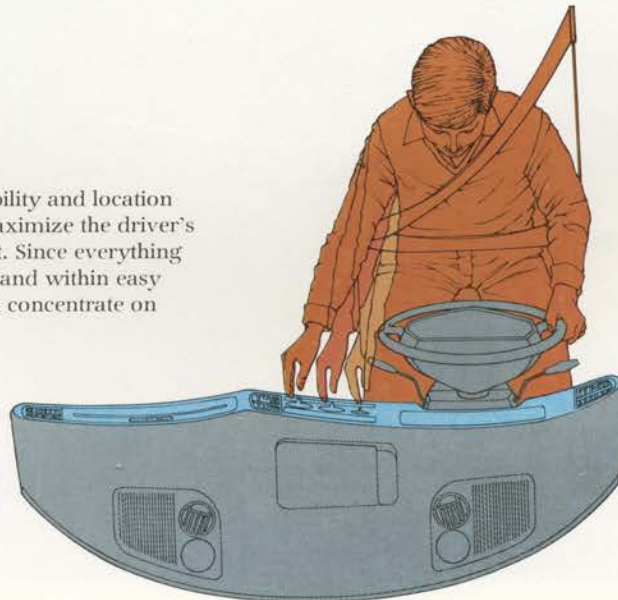



1.

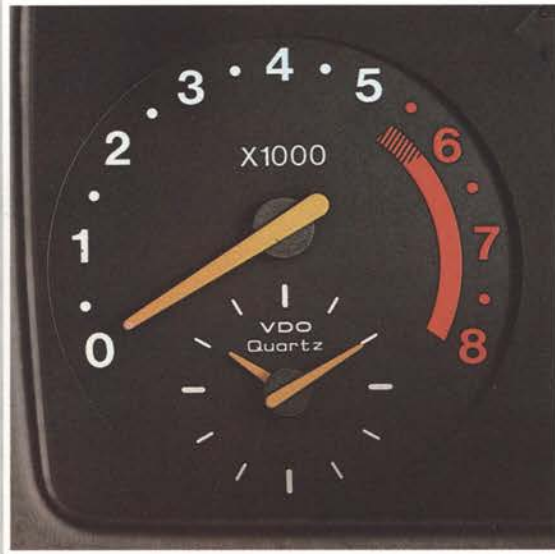

2.



3.



4.

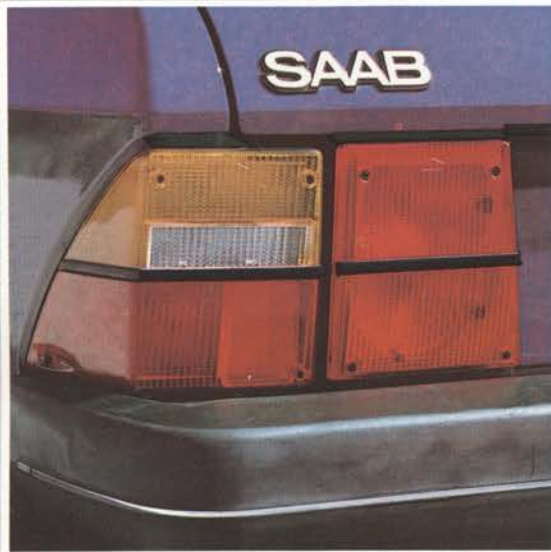

5.



6.

1. Steering wheel rim with soft padding. (Pictured: GLi.)

2. The Saab 900 has large, easy-to-read instruments with green lighting. The picture shows the tachometer for the Saab 900 EMS and the Saab Turbo.

3. Electrically controlled interior mirrors are optional on the Saab 900 GLE and standard on the Saab 900 Turbo models.

4. Two loudspeakers in the top of the instrument panel are standard equipment. The location, below the windshield, guarantees excellent stereo effect.

5. The 1980 Saab 900 has entirely new and larger rear light clusters. They include direction indicators, reversing lights, brake lights, tail lights and reflectors.

6. In the Saab 900, the controls are logically arranged in groups. The picture shows the center console where all starting controls are located: ignition key, gear lever and handbrake.





SAAB 900 GLi





PASSENGER AND CARGO. IN THE SAAB 900 YOU DON'T HAVE TO CHOOSE BETWEEN THE TWO.

The Saab 900's are roomy five passenger cars that still leave room for an amazing amount of cargo. The luggage compartment converts within 30 seconds into a large cargo space. Skis, golf equipment, even outboard motors can easily be accommodated. The load carrying area has a maximum length of 72.2 inches, a height of 36.2 inches and a total capacity of 53.0 cubic feet. The rear door of the Saab 900 extends from the edge of the roof



right down to the bumper. Gas springs automatically lift the rear door. This makes loading the 900 a snap, since there's no sill obstructing the rear. And for heavy objects the rear bumper serves as a convenient support.

The load capacity of the Saab 900 can be adjusted three ways to suit every need.

- Ordinary luggage compartment with package shelf in position and seating for five.
- Ordinary luggage compartment, package shelf removed and seating for five.
- Large load area with seating for two.

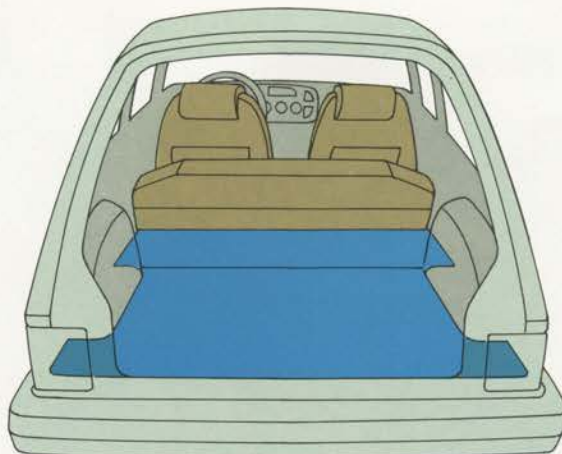



SAAB 900 TURBO



ZAMIR



NOTHING PERFORMS LIKE A SAAB. NO SAAB PERFORMS LIKE A TURBO.

The world is filled with cars that seem to be stamped out by a cookie cutter. But there's still a chance to own a thoroughly unique automobile. The new Saab 900 Turbo. Something about a Turbo makes people who drive it buy it.

The performance car perfected. At the heart of this excitement is the Saab turbo engine. Saab engineers took the kind of power that dominates the big race tracks like Indianapolis and LeMans and harnessed it to work at everyday driving speeds. They did this by designing a turbocharging system that puts out more torque at lower engine speeds. So when you have to pass, or merge into fast moving traffic, there's an incredible surge of power at your disposal.



A feel for the road. In addition to having extraordinary power, the new Saab Turbo is uniquely equipped to control it. A longer wheelbase, new suspension geometry and front wheel drive give the car cat-like agility—even on rain, snow and ice. Gas filled shock absorbers and rack-and-pinion steering help you to cling to the road. Power assisted 4-wheel disc brakes and high performance low profile radial tires bring the Turbo to smooth, sure stops.

Sports car excitement/Comfort for 5. While the new Saab Turbo will give you and four passengers the driving thrill of a lifetime, the interior environment is tasteful, restrained and superbly organized. The relationship between the steering wheel, windshield and the hood provides an ideal field of vision. The driver faces a handsome new instrument panel where all controls are located in specialized zones for optimum convenience.

Engineered in Sweden, this is one of the world's most unique cars. For sheer comfort, excitement and driving confidence nothing performs like a Saab Turbo.

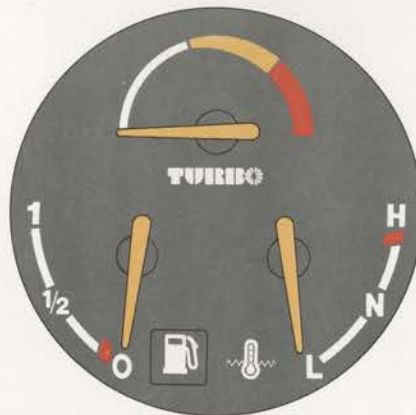

This small instrument tells the driver the relative intake manifold pressure (i.e. boost or vacuum) and whether the turbocharger is operative.

SAAB 900 TURBO



THE SAAB TURBO CHARGER, TURBOCHARGING ONLY WHEN YOU NEED IT.

A turbocharger is a turbine and a compressor mounted on a common shaft. The turbine is driven by the engine's exhaust gases.

So just why is the Saab turbocharger different? Saab engineers have developed a turbocharging system using a turbocharger that is remarkably small. So only a relatively modest gas flow is required to begin driving the turbine. In other words, we found a way



to harness turbo power and put it to use at normal driving speeds. But there is also one other very important aspect. The Saab turbo-

charger only comes into play when it is actually needed: when you have to pass, merge into fast moving traffic, or accelerate uphill.

At other times, the turbocharger is inactive and the engine runs as a conventional Saab fuel injected engine.

All this technical wizardry produces an automobile that provides an unmatched sensation for even the most demanding driver.

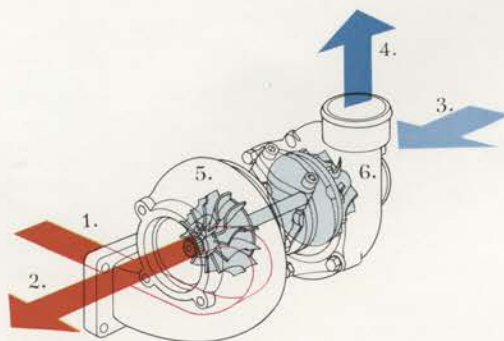

The Saab Turbocharger:
1. Exhaust gas inlet. 2. Exhaust gas outlet from turbine. 3. Engine air intake. 4. Compressed air outlet to the cylinders. 5. Exhaust gas turbine. 6. Compressor impeller.

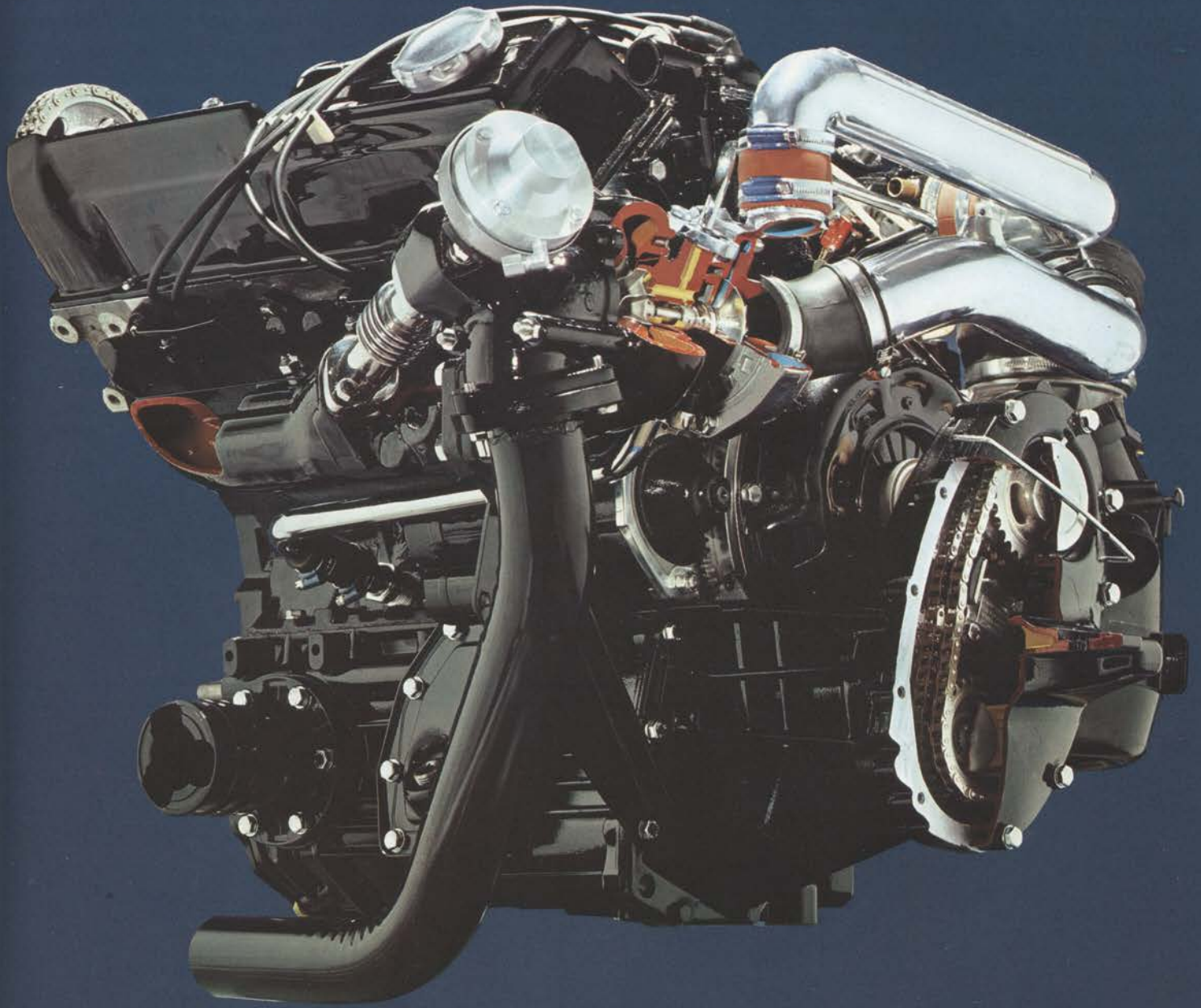

THE SAAB 900.
DESIGNED INSIDE
AND OUT FOR SAFETY.



Security on wheels.

- Front engine and front-wheel drive for excellent road-holding and directional stability. Powerful engine for safe passing.
- Rack-and-pinion steering for accuracy.
- Pivot mounted front springs. Long spring travel. Efficient springing and good road-holding under all road conditions.
- Large wheels that grip firmly in snow and on other loose surfaces.
- Lightweight, straight, one piece rear axle. Accurate tracking, smooth ride, and maximum traction on any road surface.
- Self-adjusting, power-assisted disc brakes all round. Outer front linings of semi-metallic type. High and uniform braking capacity.
- Diagonally split, dual-circuit brake system. Failure of one circuit will not significantly affect steering and roadability.
- The brake lines are well protected.
- The wheel design helps keep the brake discs clean.
- Effective emergency handbrake. Acts on the front wheel discs.
- Headlamp adjustment screws accessible through notches in the bezels.
- Large corner light clusters with wide visibility arcs and well-separated functions including standard cornering lights.
- Windshield wipers with extra large sweep area on the driver's side.
- Large, sensibly located exterior mirrors with anti-dazzle treatment (electrically controlled mirrors are standard on Turbo models and optional on the GLE).
- Day/night interior rear-view mirror.
- Semi-automatic heating and ventilation system with programmed, accurate setting for air distribution. Easily adjustable controls.
- Driver's seat with a wide variety of settings. Electrically heated seat and backrest on the EMS, GLE and Turbo.
- Concave instrument panel, with logical arrangement of controls and switches in separate zones for easy identification.
- Large, easy-to-read instruments. Indicating lamps grouped at the top of the instrument cluster.

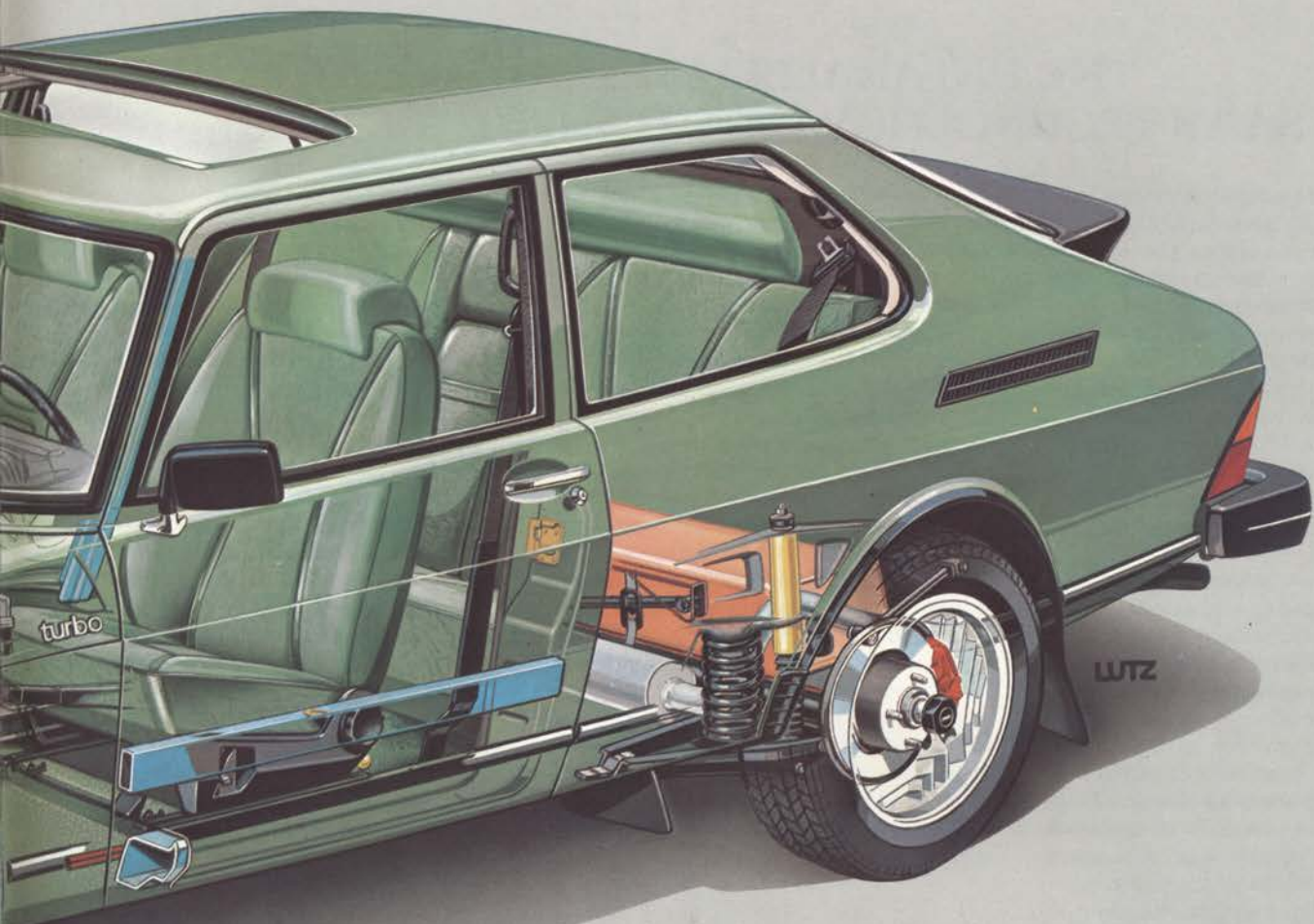

Passengers come first.

- Steering wheel rim with soft padding. Impact-absorbing, perforated sheet metal cage below the steering wheel.
- Jointed and telescopically collapsible steering column. Equipped with sheet-metal bellows which will bend when subjected to a high load. Steering gear in well-protected location, far back in the engine compartment.
- Instrument panel with effective, impact-absorbing padding.
- Safety cross-member under the instrument panel. With mountings for steering column, heater, etc.
- Impact-absorbing leg shield below the instrument panel, designed to protect the occupant's knees.
- Windshield shaped and located so that the occupants are less likely to strike it in the event of hard braking. Padded windshield pillars.
- Roof lining of moulded glass fiber. Provides impact-absorbing protection across the roof reinforcing members.
- Heavy padding on the head restraints and the rear of the front seats.
- Front seat belts of inertia reel type.
- Childproof rear door locks.
- Recessed interior door-opening handles.
- Rugged steel sections in the windshield pillars. Sturdy door pillars and reinforcing sections around the roof. Strong steel members in the doors. Specially reinforced sill beams and cross-members to strengthen the body.
- Crumple zones with high energy-absorbing capacity at the front and rear.
- Effective bumpers—self-repairing after low-speed collisions.
- Safe location of the fuel tank—in the space between the rear wheels.

THE UNPARALLELED SAAB 900. SAAB TECHNOLOGY PUTS IT ALL TOGETHER.

The body. The development of the Saab safety body is based on sophisticated "collision research". This has resulted in a body which, in addition to the traditional crumple zones at the front and rear, also incorporates numerous protective and reinforcing members.

Consider the windshield pillars, for instance. U.S. regulations concerning their strength are the world's most stringent. The windshield pillars of the Saab 900 exceed those standards by 40%.

The anti-corrosion treatment carried out at the factory is also impressive! All Saab 900 cars are subjected to a comprehensive anti-corrosion treatment at various stages of the manufacturing process.

The engine. The basic engine of the Saab 900 is an in-line 2-litre overhead cam, liquid-cooled, 4-cylinder fuel injected engine. All versions are equipped with a three way catalyst and Lambda control system for low emissions.

The rating of the engine is 110 hp (81 kW) SAE net at 5500 rpm. The turbocharged version has a maximum output of 135 hp (100 kW) SAE net at 5000 rpm.

Considering its class and performance level, fuel economy is excellent.

The transmission. Saab engineers were always aware that if the car was to have sporty performance, the body, engine and gearbox must carefully match each other.

Another objective was that the engine, clutch, differential and gearbox, should be as compact as possible. This allows more space for the front-seat passengers. At the same time, the power train contributes to excellent weight distribution between front and rear axles.

Apart from the 4-speed manual gearbox and the automatic transmission, the 1980 range includes a 5-speed manual gearbox. When combined with the turbocharged engine, for example, the 5-speed reduces engine speed by 13% in fifth gear, yielding a reduction in fuel consumption at speeds between 30 and 65 mph as well as a reduction of 2-3 dBA in the sound level at speeds between 55 and 65 mph.

The brakes. In the interest of safety, the brake system of the Saab 900 consists of two separate circuits.

The system is diagonally split. If one circuit should fail, the brakes of one front wheel and the rear wheel on the opposite side will remain operative. So the braking effort at the front and rear will stay normally distributed. And the steering and road handling of the car will remain largely unaffected.

The handbrake serves as a third brake circuit and acts on the front wheels. The braking effect of the handbrake alone is at least 50% of the total foot brake effect.

Springing and wheel suspension. The front suspension is based on a lightweight but double strong wishbone system. The wishbones, combined with separately mounted shock absorbers and coil springs, provide good stability and durability for the front suspension.

The front springs are pivot mounted. They remain straight during compression, and do not "bow" out, thus retaining springing capacity. In addition, the spring travel is relatively long, for better ride and handling characteristics over a variety of road surfaces.

Body with front and rear collision zones. Rigid passenger compartment with substantial impact-absorbing padding.

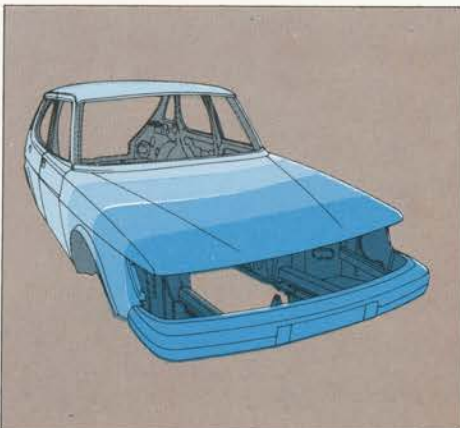

Diagonally split brake system. Disc brakes all round.

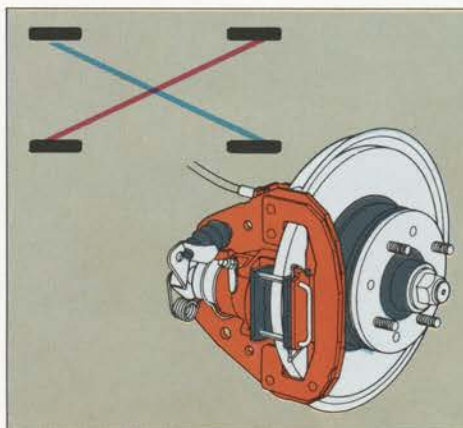

Pivot-mounted front springs. Full springing capacity without tendency to buckle during compression.

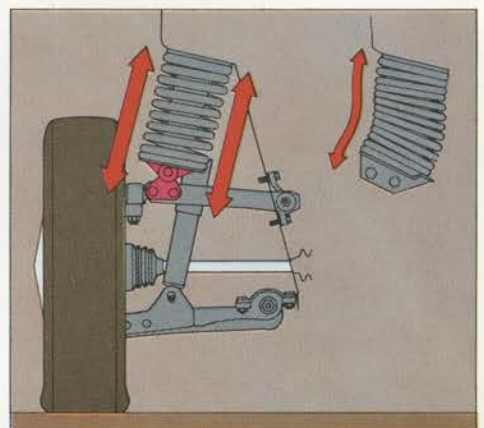

The rear axle is a straight, one piece unit. The wheels are thus aligned perpendicular to the road surfaces. This ensures the best possible roadholding of the rear wheels. In addition, the rear axle is lightweight and its unsprung weight is low, allowing the rear wheels to follow the irregularities of the road surface accurately without appreciably affecting the ride comfort.

The bumpers. In 1972 Saab launched the first bumpers worthy of their name. At collision speeds of up to 5 mph, the cellular blocks in the bumper compress, but soon expand back to their original shape. This characteristic in itself has saved many Saab owners a lot of money.

The steering. It is primarily the distribution of weight—with most of it carried by the front wheels—to which the Saab 900 owes its directional stability and its consistent roadability.

The car has a slight amount of understeer, i.e. it follows a somewhat wider radius in a turn than that corresponding exactly to the movement of the steering wheel. To correct, the driver need only turn the steering

wheel slightly more to the inside of the turn, which is a natural reaction.

The steering system of the Saab 900 is actually so advanced that a blow-out (when the car is traveling straight ahead) on a good road will hardly affect the steering performance.

The rack-and-pinion steering gives reliable performance without backlash. The wheels react immediately to the slightest movement of the steering wheel.

The top end of the steering column is secured to a heavy cross-member which also supports the instrument panel, components of the heating system, etc.

On the interior side, a perforated sheet metal cage acts as an impact-absorbing component—in addition to the center pad, with its deformable body and its surface covering of soft, resilient material.

The telescopic intermediate shaft between the steering column and the steering gear incorporates double universal joints and a cylindrical sheet metal bellows. The function of the latter is to allow the steering column to collapse in the event of impact.

In addition, the steering gear is located far back in the engine compartment in a well protected position. As far as we know, no safer steering system exists.

Heating and ventilation system.

The heating and ventilation system of the Saab 900 is simpler than most other cars. It is a semi-automatic system with settings programmed in a careful order.

Some of the refinements: a ventilation intake on the hood was developed in wind tunnel tests, to provide constant ventilation air flow, regardless of the road speed. Vacuum control of the air flow dampers. A wide variety of settings for the air outlets on the instrument panel. A ventilation air filter which prevents virtually all dust, pollen and other small particles from getting into the interior.

Bumper with cellular blocks which are compressed on impact.

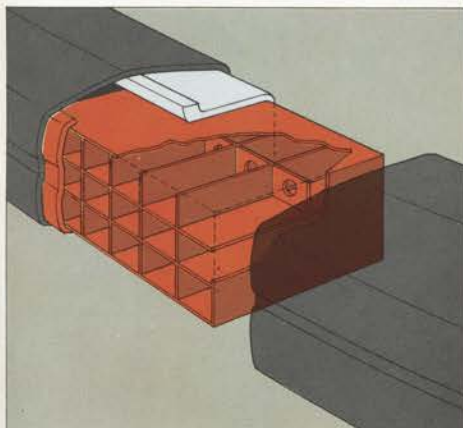

One of the world's safest designs for a steering column.

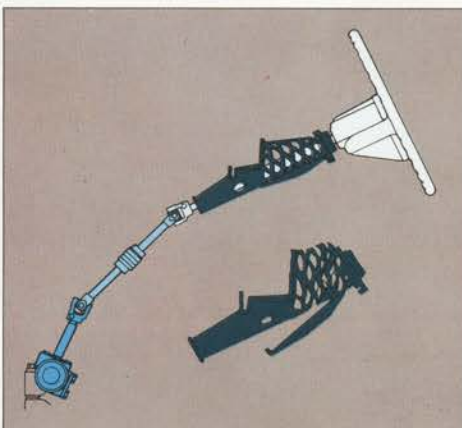

Unique ventilation filter which effectively stops dust, pollen and other solid pollutants. (Not available on cars equipped with air conditioning.)

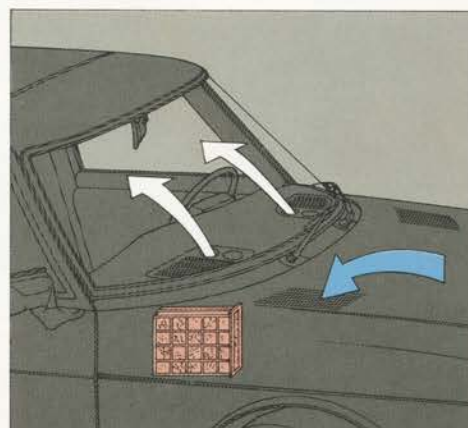

SAAB ACCESSORIES - FOR THE PERSONAL TOUCH.

As practical and sporty as all Saab cars are, a broad range of accessories enables every owner to enhance the comfort and appearance of his or her car in a very personal way.

Radio and Air Conditioning.

A great selection of quality radios with AM/FM stereo and cassette combinations. Saab air conditioning offers the maximum in quiet cooling efficiency.

Accessory Console.

A CB Radio, tachometer, amp gauge or oil pressure gauge. The Saab console can accommodate all of these and more while giving you an extra storage tray too.

Auxiliary Lighting.

For that extra margin of safety in inclement weather or for additional lighting required by the driving enthusiast, Saab auxiliary lighting puts more light on the subject.

Speed Control.

Enjoy more relaxed driving and improved fuel economy—at your fingertips with Saab speed control.

Trailer Hitch and Roof Rack.

Trailer hitches complete with wiring harness and roof racks for all your transport needs.

Accent Stripes.

Add to the sporty appearance with decorative accent striping.

In addition to those illustrated other available accessories include: Aluminum alloy wheels - Tachometers - Spoilers - Engine heaters - Radial tire chains - Ski racks - Passenger seat heaters - Seat covers - Textile and rubber floor mats - Spare fuel cans - Locking gas caps - Leather key fobs.

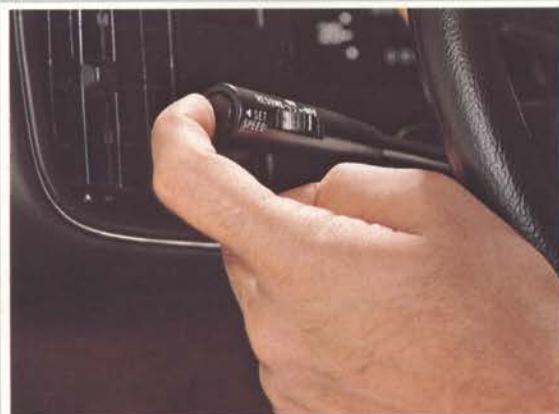

■ Accessories shown and mentioned above are available in the United States.

EXTERIOR COLORS.*



A. Solar red

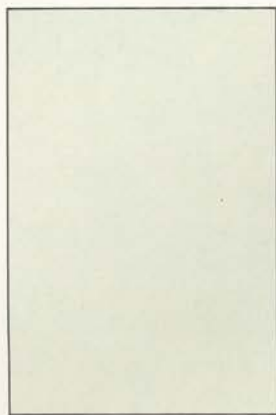

B. Marble white



C. Chamotte brown



D. Dorado brown



E. Alabaster yellow



F. Midnight blue



G. Carmine red metallic



H. Acacia green metallic



J. Aquamarine blue metallic



K. Anthracite grey metallic

INTERIOR COLORS.



B H



A F G J



C D E



G K



F J



B H

■ The above mentioned interiors apply to the GLi models.

■ The above mentioned interiors apply to the EMS, GLE and Turbo models.

*) Talk to the Saab dealer about which colors apply to the different models.

TECHNICAL SPECIFICATION SAAB 900, 1980.

	Saab 900 GLi, 3 door.	Saab 900 EMS, 3 door.
Engine.	4-cylinder, liquid-cooled, in-line engine with overhead camshaft. The longitudinally mounted engine is inclined at 45° and is differential; the clutch faces forward. Alloy cast iron engine block. Light aluminum alloy cross-flow cylinder head and intake Sodium cooled exhaust valves.	
	Displacement 121 cu in (1985 cc). Cylinder bore 3.54 in (90 mm). Piston stroke 3.07 in (78 mm).	
	Compression ratio 9.2:1.	
	Horsepower SAE net 110 hp (81 kW) at 5500 rpm.	
	Peak torque 119 ft lbs (161 Nm) at 3500 rpm.	
	Mechanically controlled Bosch CI fuel injection. Recommended octane 87.5 Minimum Octane Rating (AKI) by (R + M)/2 m	
	12 V/60 Ah battery, maintenance-free.	
	Alternator with max. output of 950 W, 14 V/70 A. Breakerless electronic ignition system.	
	Starter motor rating 1.1 hp (0.8 kW).	
	Cooling system of pressurized type. Cross-flow radiator and separate expansion tank. Coolant volume, incl. heating system, 10	
Power Transmission.	Manual gearbox. Hydraulically actuated dry-plate clutch; clutch and primary drive at front of engine; gearbox and differential two permanently lubricated universal joints drive each front wheel.	
	Four speed manual transmission.	
Chassis.	Four wheel disc brakes. Brake pads area 35 sq in (228 cm ²). Brake swept area 388 sq in (2504 cm ²). Diagonally split dual-circu Self-adjusting foot brake and handbrake. Handbrake acts on the front discs. Semi-metallic outer brake linings at the front.	
	Lateral wishbones and pivot-mounted, progressive action coil springs at the front. Lightweight, straight, one piece rear axle, gui	
		Double-acting gas pressurized shock absorbers all round.
	Rack-and-pinion steering gear. Jointed and telescopically collapsible steering column with cylindrical sheet metal bellows. Impact below the steering wheel. Turning circle diameter 33.8 ft (10.3 m).	
	Steel wheels with hub cap and trim rings, 5 Jx15" FHA. 165 SR 15 steel cord tires. (Temporary use-type, compact spare on special steel rim.)	Light alloy wheels, 5 Jx15" FHA. 175/70 HR 15 low-profile tires. (Temporary use-type, compact spare on special steel rim.)
Dimensions and Weights.	Overall length 187.6 in (4764 mm). Overall width 66.5 in (1690 mm). Height unladen 55.9 in (1420 mm). Wheelbase 99.4 3-door Turbo 56.3 in (1430 mm). Track rear 56.3 in (1430 mm) ; 3-door Turbo 56.7 in (1440 mm). Max. luggage compartme Ordinary luggage compartment 13.5 cu ft (383 litres) SAE; 16.1 cu ft (457 litres) SAE with parcel shelf removed. 1.1 cu ft at rear. Luggage compartment volume with back seat folded down 53 cu ft (1500 litres).	
	Curb weight approx. 2630-2690 lb (1195-1220 kg).	Curb weight approx. 2690-2720 lb (1220-1235 kg).
	Gross vehicle weight rating 3730-3790 lb (1690-1720 kg).	
Standard Equipment.	Effective bumpers which are self-repairing after low-speed collisions. Large corner light clusters with direction indicators, parking Rear light clusters include brake lights, parking lights and reversing lights. Two-speed and interval pulse windshield wipers. L Hazard warning lights. Reflectors on driver's side door edges. Tow lugs front and rear. Front spoiler. Anti-corrosion priming	
	Padded steering wheel rim and impact absorbing center pad. Energy absorbing steering column, of advanced safety design. Instr Impact-absorbing shield below instrument panel. Rheostat controlled green instrument lighting. Full complement of indicating lan rear-view mirror. Instrument panel mounted stereo loud speakers.	
	Front seats incorporating lumbar support and vertically adjustable head restraint. Stepless backrest rake adjustment. Driver's front seat belts. Rear lap belts. Grab handles under instrument panel and above passenger doors. Roof lining of molded glas rear side windows (3-door models). Tinted glass all windows. Heating and ventilation system: Semi-automatic with vacuum c of rotary controls for fan, temperature and air distribution; Defroster outlets for both windshield and side windows; Air outlets and to rear footwells; Highly efficient ventilation air filter (not available on cars fitted with air conditioning).	
	Non-dazzle interior lighting. Ignition key lighting. Map-reading lamp. Glove compartment lighting. Luggage compartment lighting	
	Variable luggage compartment capacity. Carpeted luggage compartment floor. Fabric-covered, easily removable parcel shel	
		Electrically heated driver's seat. Folding center armrest in ba
		Power assisted steering. Three-spoke sports steering wheel. Tachometer. Sliding steel sunroof.
Optional Extra Equipment.	Automatic transmission/power steering.	Automatic transmission. Metallic paint.

1) Five-door model.

2) Three-door model.

3) Available as a package only, and cannot be ordered separately.

Saab 900 GLE, 5 door.

Saab 900 Turbo, 3 and 5 door.

is integrated with the clutch, gearbox and
ke manifold. 5-bearing camshaft and crankshaft.

Camshaft and pistons of special type.

Compression ratio 7.2:1.

Horsepower SAE net 135 hp (100 kW) at 5000 rpm.

Peak torque 160 ft lbs (217 Nm) at 3500 rpm.

method (equivalent to RON). Fuel tank capacity 14.5 U.S. gallons (55 litres).

Turbocharger. Charger pressure controlled with
spring-loaded diaphragm valve. Safety system
with pressure switch.

10.8 US quarts (10 litres). Electric motor driven, thermostatically controlled radiator fan.

Thermostatically controlled, air-cooled engine oil cooler.

atal below engine; primary drive by chain;

Five speed manual transmission.

rcuit hydraulic foot brake system with 9-inch vacuum servo.

guided by two leading and two trailing arms and a Panhard rod.

act-absorbing, perforated sheet metal cage

Steel wheels with full-wheel covers, 5 J×15" FHA.
165 SR 15 steel cord tires. (Temporary use-type,
compact spare on special steel rim.)

Light alloy wheels. 3-door model: 5½ J×15" H2;
195/60 HR 15 Pirelli P6 tires. 5-door model: 135 TR×390 FH;
180/65 HR 390 Michelin TRX tires. (Temporary use-type,
compact spare on special steel rim.)

4 in (2525 mm). Track front 55.9 in (1420 mm);
ment length (seat folded down) 72.2 in (1835 mm).
ft (30 litres) SAE compartment below hatch

Curb weight approx. 2790–2920 lb (1265–1325 kg).

Curb weight approx. 2760–2880 lb (1250–1305 kg).

Gross vehicle weight rating 3860–3880 lb (1750–1760 kg)

Gross vehicle weight rating 3790–3880 lb (1720–1760 kg).

ng lights, cornering lights. Side guidance reversing lights.
s. Large, well located outer rear-view mirrors with anti-dazzle treatment.
ing by electrodeposition.

struments and controls on concave instrument panel.
lamps. Trip meter. Clock. Day/night interior

r's seat cushion adjustable in height and tilt. Inertia
lass fiber. Electrically heated rear window. Opening
n controls; 12 interior air outlets; Central location
ets in the front footwells, close to the front doors,

ting. Automatic headlamp control (headlamps automatically switched off with the ignition).

half. Easily accessible spare wheel.

back seat.

Power assisted steering. Electrically heated co-driver's seat.

Power assisted steering. Electrically operated rear-view
mirrors. Three-spoke sports steering wheel. Tachometer.
Electrically heated co-driver's seat.¹ Rear-seat headrests.
Rear deck spoiler.² Air conditioning.¹ Sliding steel sunroof.

Automatic transmission. Light alloy wheels with Michelin
TRX tires.³ Air conditioning.³ Sliding steel sunroof.³ Electrically
operated exterior rear view mirrors.³ Rear seat headrests.³

Metallic paint.

■ A Tourist Delivery Plan is available.
Your dealer can supply information.

■ The manufacturer reserves the right
to alter the specifications and equip-
ment without notice.

SAAB

Nothing performs like a Saab.

Saab-Scania, Saab Car Division
Nyköping, Sweden

Saab-Scania of America, Saab Drive, Orange, CT. 06477