

Saab 99E
It's about time
a car was built
like this.



It's about time a car was built like this

It's about time a car was built like this

WHEN WILL car makers build a really safe car? A car with all those safety features the government keeps talking about. Features like a built-in roll cage, energy absorbing bumpers, protected gas tank, and impact absorbing front and rear end.

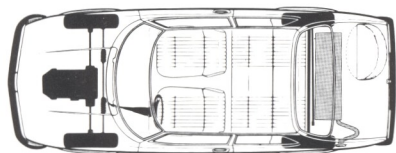

Well we have news for you, there's a car already made with all these features. The Saab 99.

For example. Take our roll cage construction. Roll cage construction means beams surrounding the passenger compartment to give you extra protection in case of an accident. In tests in Sweden the Saab 99 has been dropped on its roof from a height of 7 ft. The passenger compartment remains intact. And this year, the 99 has new bumpers, front and rear, to absorb shocks before they get to you (and to prevent minor bumps from

becoming major repair bills). There are all kinds of other features too which we'll tell you more about later.

But to us safety doesn't just mean protecting you in case of an accident, it means helping you avoid accidents. And that's the reason for Saab features like front wheel drive, dual diagonal brakes and rack and pinion steering. After all avoiding an accident is better than having one.

Just because a car is safe doesn't mean it shouldn't be fun to drive and comfortable. Far from it. Our padded contoured seats adjust to the right position for just about any size body. And because of our front wheel drive there's no drive shaft tunnel to make life miserable for passengers in the back seat.

Some of our features you can appreciate by just looking at the car. Others like the ones under the hood you have to look a little harder for. But they're all there for just one reason: to make driving easier and safer for you.

A brief technical look at the Saab 99

Engine: Front mounted. Four cylinder overhead cam straight-4 1854 cc. 95 net horsepower (SAE). Fuel injection.

Transmission: Front wheel drive. 4 speed manual or 3 speed automatic.

Body: Two or four door sedan. Seats five full-sized adults. Gas tank located between the rear wheels.

Saab's new bumper can take punishment

The 1972 Saab 99 has new energy absorbing bumpers front and rear. They are made with heavy U-shaped steel rails, energy absorbing cellular plastic blocks, all covered with black rubber. They can elastically absorb a force that would mean damage and repair bills for cars with ordinary bumpers. It's about time a car was built with a bumper like this.



import motors inc.
Sales - Parts - Service
1685 Mentor Ave. Ph: 352-9625
Painesville, Ohio 44077

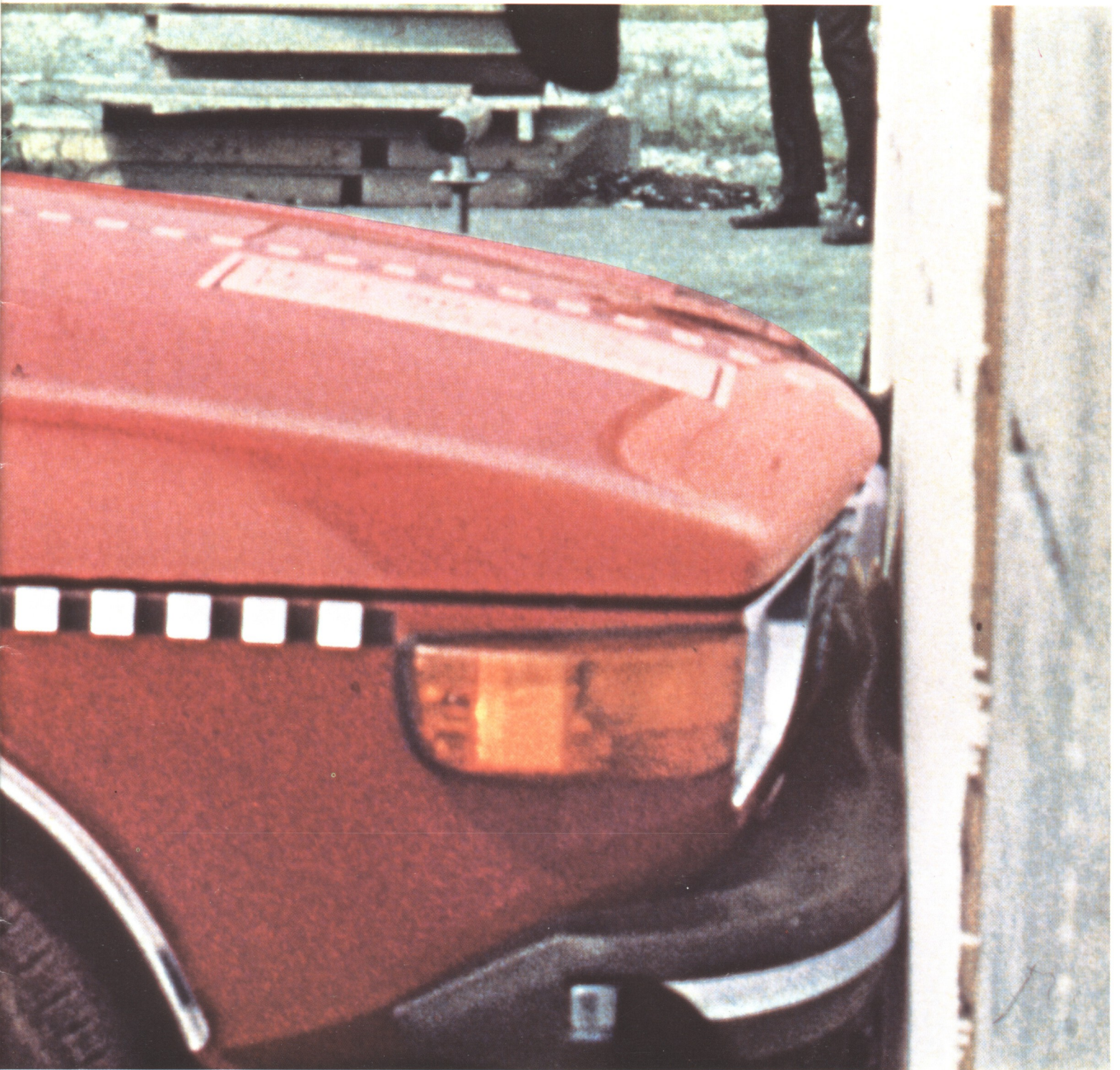





1991

0A23863



Starting. Driving. Stopping

import motors inc.
Sales - Parts - Service
1685 Mentor Ave. Ph: 352-9625
Painesville, Ohio 44077

YOU REALLY don't know a car until you've taken it out for a ride. And that's when you'll really begin to appreciate the Saab 99.

The first thing you'll notice is the terrific handling. That's because of the front wheel drive. The engine's power (along with it's weight) is right over the driving wheels. The car is pulled around tight turns, not pushed like cars with rear driving wheels. That means less chance of skidding and fantastic traction in the snow. (Coming from Sweden we know a bit about snow.)

The Saab 99 gives you the control you need on America's high speed high-ways. The aerodynamic design keeps the car exceptionally stable even in high cross winds. (Saab is also Sweden's leading manufacturer of advanced jet aircraft. So we know a bit of aerodynamics too.)

You'll feel additional control from the rack and pinion steering (a feature all racing cars have), our wide radial tires, and our unique fail-safe dual diagonal braking system and 4 wheel disc brakes.

If you've ever fumbled around a dashboard looking for the windshield wiper switch or the headlight button, you'll appreciate the Saab's instrument panel. We've designed it sort of like an airplane's dash (remember we make those too). Everything is right there within easy reach; either on the dashboard or on the center console. And they're all clear and easy to read.

It's about time a car was built like this.

1. The instrument dials are large and easy to read. The left of three main dials has warning and indicator lamps for blinkers, battery, oil pressure, hand brake (or footbrake system failure), gas and high beam.

2. Instrument panel is well lit for night driving.

3. Console between seats has ignition key and lock for gear change lever. When car is locked (locks only in reverse) electrical current is automatically switched off so headlights cannot be left on.

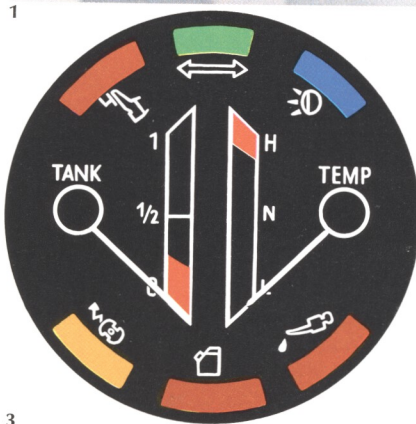

To see and to be seen

SAFETY ALSO means seeing where you're going. And being seen while you're going there. The Saab 99 lets you do both better than probably any other car on the road.

To help you see more, the 99 has an extra wide windshield. Plus narrower side pillars, a shorter hood, one piece side windows, and a large rear window. All of which let you see as much of the road as possible. And to make sure you'll keep seeing as much as possible the 99 makes sure the windows stay as clear as possible. It has extra large windshield wipers and defrosters for the front, side and rear windows.

But just seeing where you're going isn't enough these days. You also have to be seen. So we've put our blinkers and parking lights high up on the car. From the front, rear and sides the 99's signals can be seen clearly.

1. Two speed windshield wipers with separate washer controls. Electrically driven washer. Extra large water container.

2. Two effective defroster outlets for the windshield clears windshield in the shortest possible time.

3. Side window defrosters.

4. Visibility, rapid defrosting, easy starting, and superb traction make the Saab 99 the perfect car for driving on snowy and icy roads.







P65072





Sit back. Relax

IT'S A VERY sneaky car. The Saab 99. It has much more room on the inside than you'd ever imagine from looking at the outside. The front seats are contoured and adjustable to almost any position. After all if you're comfortable you drive better.

Now you don't have to sit down on a cold car seat on a very cold morning. We've developed an electrically heated driver's seat, the only one of its kind in the world.

And we don't forget about the passengers in the back seat. The (2-door-) 99's back seat is 60.6" wide at elbow height. And because of our front wheel drive, there's no drive shaft tunnel for the man-in-the-middle to straddle.

The Saab 99 also has a 21 duct flow-through ventilation system which recirculates fresh air inside every thirty seconds.

These are all reasons for being comfortable inside the car. But today people are also worried about what goes on outside; the air we have to breathe.

Well the Saab 99E does something about that too. It comes with fuel injection that enables the engine to perform at peak efficiency, and cuts down on wasteful exhaust emissions.

1. Sturdy, durable and color coordinated upholstery. Vinyl reinforcements at sides and arms.

2. The backrests are adjustable. The driver's seat can be adjusted for height and angle. The seats are also adjustable lengthwise.

3. A thermostat controlled "heating grid" in the driver's seat. It warms the seat on cold mornings.

4. Fresh air outlets at the sides of the dash — adjustable for the right direction of the air flow.

5. Main control for the heating/ventilation system. Easily adjusted controls with color indicators and illumination. Right under is a fresh air inlet.

6. Controls for the heat for the back seat passengers and for the rear window defrosters. Placed in the center console between the front seats.

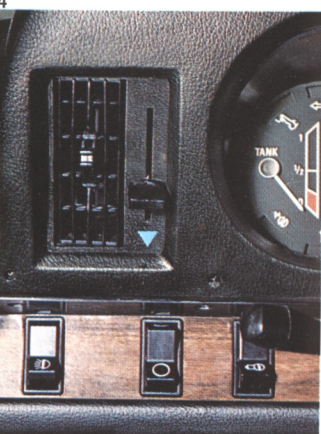
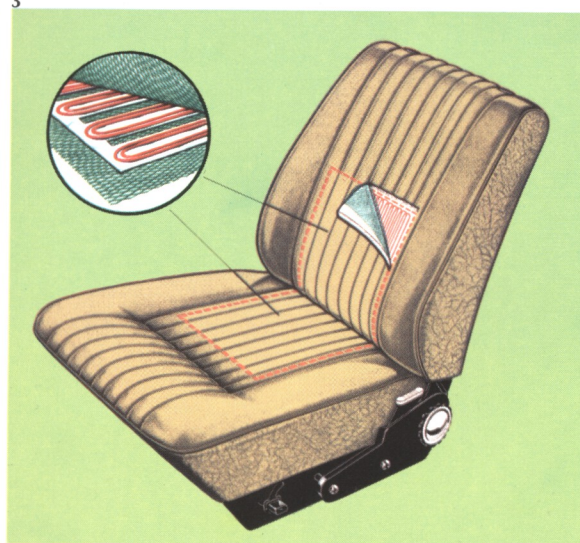
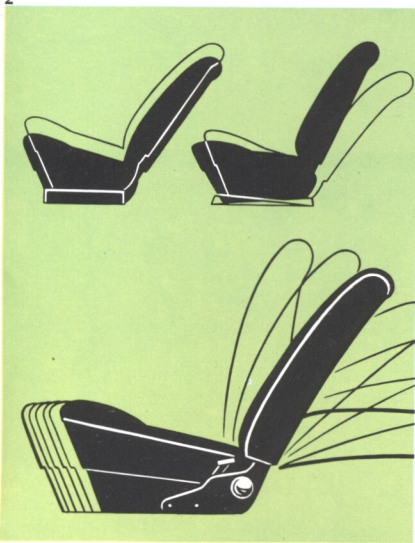

Sedan or Station Wagon?

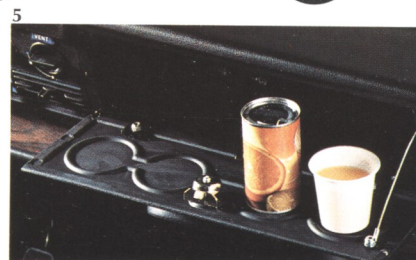
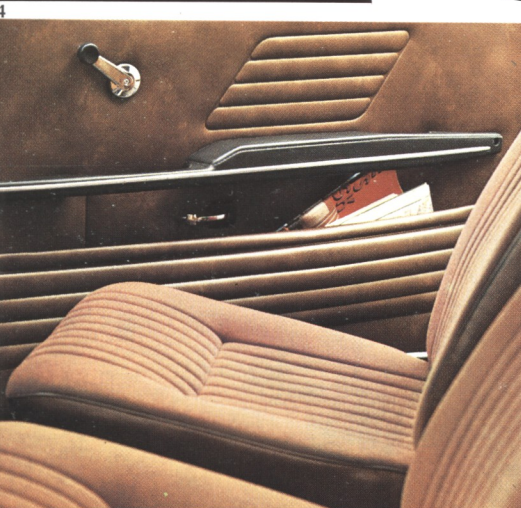
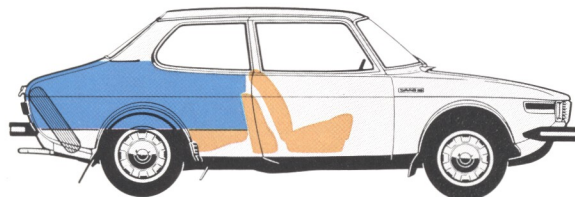
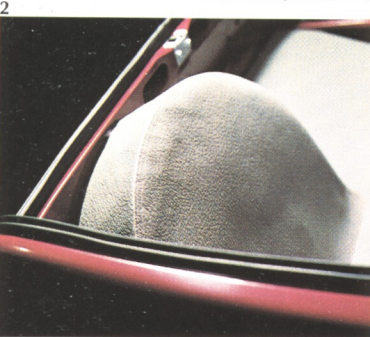

THE SAAB 99 is a car that looks like a true passenger sedan but performs like a station wagon. When the back seat is folded down, you have over five and one half feet of loading space. Even with a passenger, it can carry over 650 pounds of cargo. And with all that load the car still handles as well as it does with an empty trunk.

If you have a back seat full of passengers you can still carry a real car-full of luggage. The trunk alone has over twentythree cubic feet of space. We've made that possible by doing little things like concealing the spare tire where it takes the least amount of space. There's even a plastic cover in the trunk to keep dust off your packages, and space under the trunk to hide smaller packages (if you're so inclined) and a special hidden compartment for the tool kit.

All small things, but that's one of the main ideas behind the Saab 99. A lot of small things working for you.

1. Easy to load, large baggage space. Over five and a half feet long with a maximum width of 51 inches; at the wheel housings 43 inches.

2. Spare tire placed at rear of trunk and inclined to take a minimum amount of space. (Also makes removal easy on the back). Covered to keep dust and dirt off packages.

3. Three simple changes and the Saab 99 becomes a semi-station wagon. Fold the rear seat pad forward and release the latch on the front edge. Turn the latch on the rear deck and fold down the back rest.

4. Roomy pockets on the door sides.

5. Roomy glove compartment with a light. Enough room to carry 10 pairs of gloves or a dozen sandwiches. And the door can be used as a tray when you stop to eat the sandwiches.

6. Shelf on top of the dash for small items.



BA55008

SAAB

SAAB

Saab 99 in X-ray View

NO ONE IS about to deviate from the original construction philosophy at Saab. The safety of driver and passengers must be well provided for and the road holding characteristics must be such that they help instead of hinder the driver in a critical situation. The engine is to be in the front and the front wheels have to be the driving wheels. The gas tank and the trunk have their place at the rear.

The car must have a shape that gives low air resistance, minimal wind noise, and makes the vehicle stable in side winds. The outside dimensions should not be more than they have to be for technical reasons and to provide adequate space for passengers and baggage.

Examine the 1972 Saab 99! You will find that it follows the pattern.

1. The steering column is both jointed and telescoping. The rack and pinion steering is well back in the engine compartment.

2. Saab 99 has new bumpers that really are bumpers. Impact absorbing. Should you by mistake run into a pole or a wall . . . or another car while parking, for example, the bumper will elastically absorb the impact and bounce back again. The bumper is rubber covered and consists of a U-shaped steel rail with impact energy absorbing cellular plastic.

3. Of course Saab 99 has a dual diagonal braking system. (All Saab models have had that for eight years.) The braking system is divided, not the normal front and aft way, but diagonally. The brake cylinders are dimensioned so that about 80 % of the braking effect is at the front wheels. The entire system is power assisted. The handbrake works mechanically on the front wheels, through separate brake drums, and gives an effect of 50 % of the foot brake system. The Saab wheels look different this year, not to look prettier – (even though some may feel that they give the car a more luxurious appearance) – but to make the brakes as reliable as possible. The new design protects the brake discs against road dirt. Even the protection plates inside the discs have been improved.

4. The passenger space is framed by strong beams – along the roof line, in the windshield and side window supports and along the floor sides (the sill beams). The front and rear ends of the cars are constructed with energy absorbing zones. The X-ray view shows the strong steel profile in the windshield pillar.



Rectangular headlight

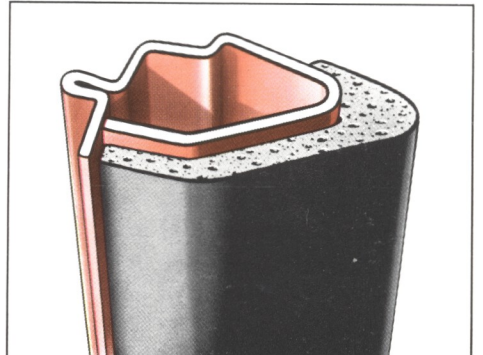
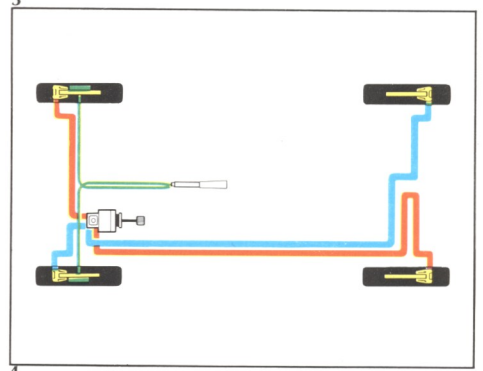
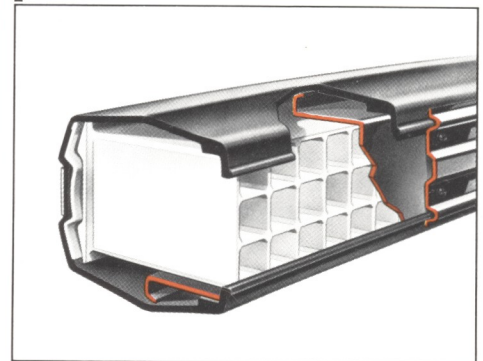
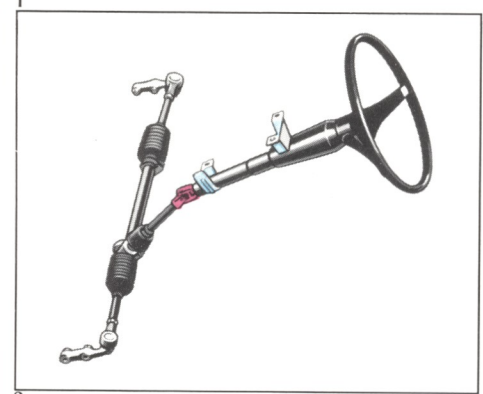
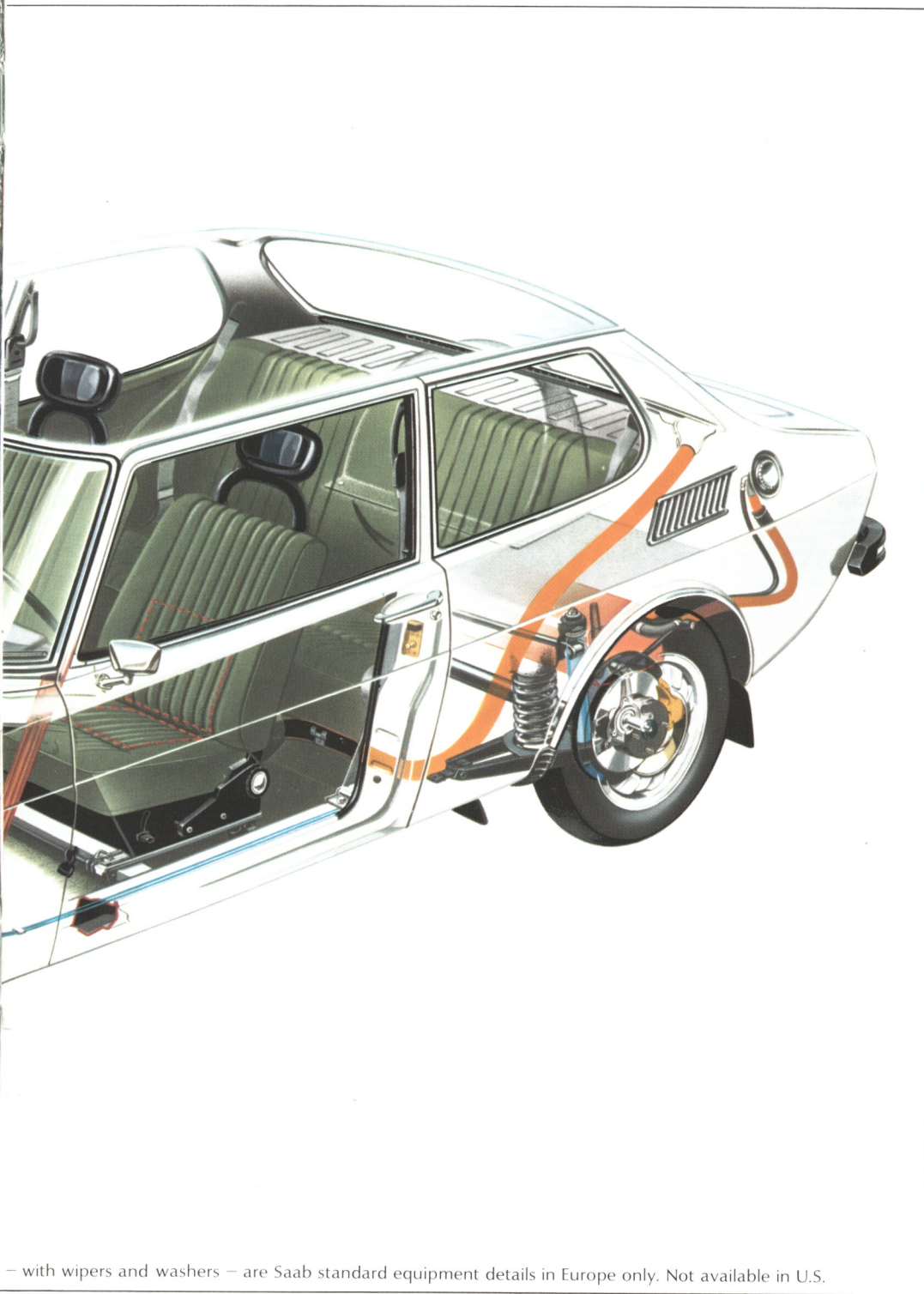

— with wipers and washers — are Saab standard equipment details in Europe only. Not available in U.S.

Engine and transmission

THE ENGINE in the Saab 99 is modern, reliable and strong. Thanks to its overhead camshaft which directly moves the valves, (no pushrods or rocker arms) the strains become minimal and the intervals between valve adjustments long. The torque curve is high over a very large range, which gives the engine that extra hard pull ability. This also reduces the need for a lot of gear changes.

Both crankshaft and camshaft have five bearings. The camshaft is chain driven. The engine is of the cross-flow type, with the cylinder head of aluminum. The intake ports are on one side, and the exhaust ports on the other. This gives the "breathing system" a shape that is advantageous both for the high revolutions and for the hard pull.

The electronic fuel system (system Bosch Jetronic) makes the Saab 99 easy to start even in the coldest winter weather.

The efficiency of the cooling system means that it requires only a small amount of coolant. Only 9 quarts . . . Since the thermostat is very efficient the engine will quickly reach its normal effective temperature after a cold start. This in turn, means that heater and defroster system (thermostat

controlled to keep the temperature even) can begin to spread hot air after only a few minutes. The cooling fan is electrically driven and will only run when the engine temperature goes above a certain level . . . for example when you are stuck in Free-way traffic jams. Most of the time the fan is still, quiet and doesn't steal unnecessary power.

Of course the Saab 99 is also available with factory equipped, efficient air conditioning.

A separate expansion tank will take any temporary overflows from the cooling system and will automatically refill the system when it cools. The large capacity battery and the alternator provide adequate power at all times.

The engine is placed so that the flywheel and the clutch are located in front and the drive chain for the camshaft on the back of the engine. The engine block is slanted 45 degrees to the right.

From the clutch the engine power is transmitted through a primary gear to the transmission, which is located under the engine and built together with the engine. Thus, the entire drive unit is one compact unit. This saves

both space and weight. (No drive axle and no rear differential). The transmission is constructed for front wheel drive. All axles and gears as well as the differential and the inner drive joints are placed under the engine.

1. The engine is slanted 45 degrees to allow for a low hood and good visibility close up. This arrangement will also allow better accessibility for service. The hood and top of the fenders are opened forward – completely out of the way.

2. Saab 99 has a well developed heating and ventilation system. Fresh air is pulled in at the rear end of the engine hood. The air is exhausted through openings at the side of the rear window and then out through the exhaust openings on the side of the body. The outlets are placed so there is no risk of exhaust fumes coming into the car during poor wind conditions.

3. Saab 99 is also available with an automatic transmission. P for parking; R for reverse; N for neutral; D for forward drive with automatic shifting through the entire range; 2 for driving in only first and second; and 1 for driving in first gear alone.

4. The engine is equipped with electronic fuel injection. With the computer controlled injection system it will always receive just the right amount of fuel and can be driven on regular grade and unleaded gasoline. The picture shows the computer which is located atop the left wheel housing.

5. The cooling fan is driven by an electric motor and will only run when needed. At normal driving it is usually standing still.

6. From the torque converter at the front of the engine the drive power is transmitted to the automatic transmission by a wide, quiet running chain.

7. The unitized body is made of extra heavy steel plating – heavier than is normal in the automotive industry. The rust protection is very carefully covered. The base paint coat is applied through the electro-dip method – the entire body is lowered into a bath with the rust protective paint, that is charged electrically, and adheres to all surfaces, even sharp edges and hollow spaces. Before the final coat is applied the bottom plate and the wheel housings are covered with the undercoating. The floor pan is pulled up at the sides so that the welding points will be protected against moisture and thus against corrosion. Hub caps and all decor are made of rustproof materials.



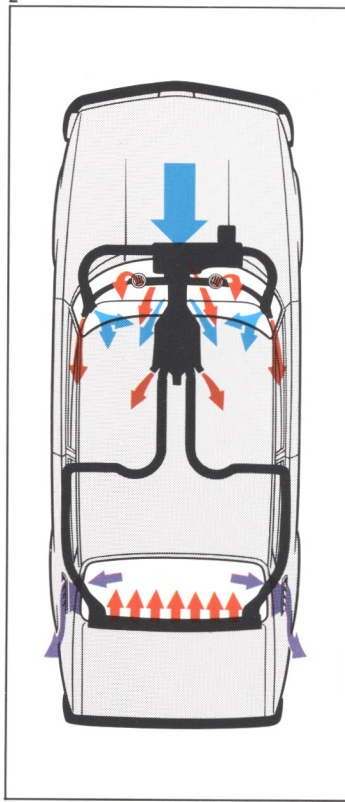
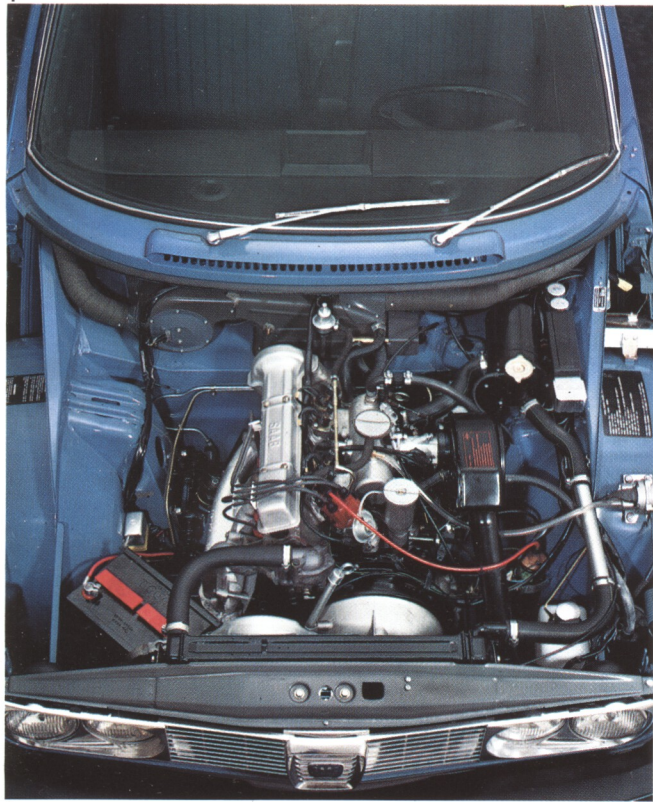

Here's what Saab offers you to keep you safer

1. Front wheel drive. (The 99 is pulled around turns rather than pushed.)
2. Even weight distribution for better stability.
3. Unitized steel body with strong twist stiffness.
4. Windshield and side supports with strong, built-in, steel profiles.
5. Sill beams of extra thick steel.
6. New, energy absorbing bumpers fastened to the energy absorbing portions outside the passenger compartment.
7. Gas tank placed between the rear wheels.
8. Dual diagonal braking system.
9. Vacuum assisted brakes.
10. Hand brake lever between the front seats for easy access.
11. Warning light to tell you of any brake problems.
12. Well protected brake lines.
13. Jointed and telescoping steering column.
14. Rack and pinion steering.
15. Four way warning flasher system.
16. Three point seat belts in front, two point seat belts in back.
17. Head restraints on the front seats.
18. Energy absorbing padding on the dash board, along the window sills, at the center of the steering wheel, in the arm rests, and sun visors, on windshield and side window supports, and at the back of the front seat back rests.
19. Rubber covered key.
20. Sun visors that can be turned to the side.
21. Collapsible day and night inside rear view mirror.
22. Non-glare outside rear view mirrors.
23. Safety door locks.
24. Reflector on edge of driver's side doors.
25. Two-speed wide sweep electric windshield wipers.
26. Easy-to-find, easy-to-reach controls.
27. Safety latches on the front seats.
28. Safety glass.
29. Effective heating and ventilation system.
30. Defroster for the windshield, the front side windows, and the rear window.
31. Radial tires.
32. Towing hooks front and rear.
33. Recessed gas tank filler cap.
34. A body design without any sharp corners.

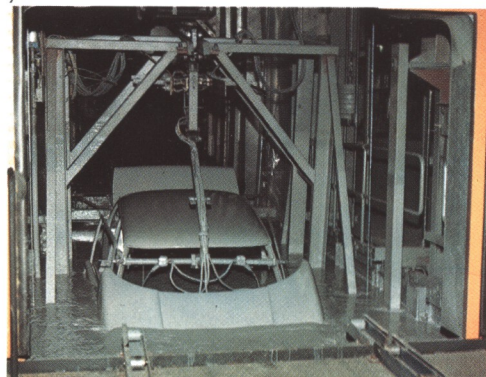
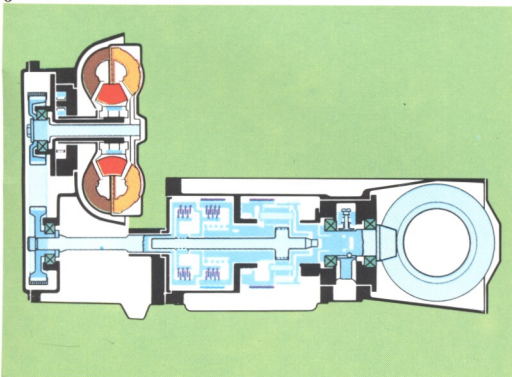
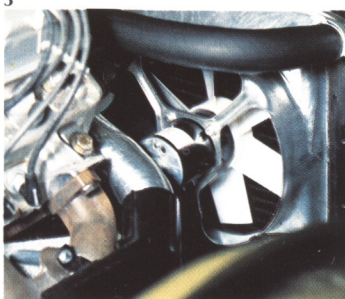
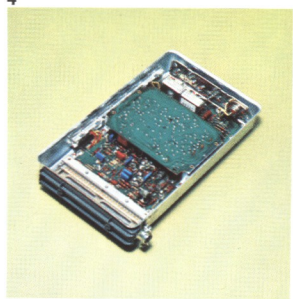
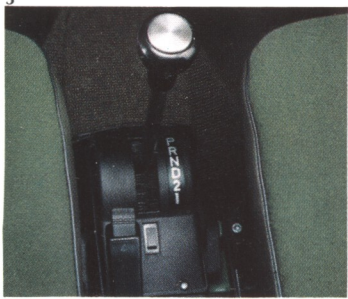

Specifications, Saab 99E, 1972

DIMENSIONS

Overall length, A	172 in.	(4370 mm.)
Overall width, B	66.5 in.	(1690 mm.)
Height, unladen, C	56.7 in.	(1440 mm.)
Wheelbase, D	97.4 in.	(2473 mm.)
Track, front, E	54.7 in.	(1390 mm.)
Track, rear, F	55.1 in.	(1400 mm.)
Front overhang, G	35.7 in.	(907 mm.)
Rear overhang, H	39 in.	(990 mm.)
Effective headroom, front, H61	38.4 in.	(975 mm.)
Effective headroom, rear, H63	37.7 in.	(958 mm.)
Elbow room, front, W5	51.9 in.	(1318 mm.)
Elbow room, rear, 2-door, W6	51.4 in.	(1305 mm.)
Rear width above armrests, 2-door	60 in.	(1540 mm.)
Elbow room, rear, 4-door, W6	52.4 in.	(1330 mm.)
Shoulder room, front, W3	53.5 in.	(1358 mm.)
Shoulder room, rear, 2-door, W4	55.2 in.	(1403 mm.)
Shoulder room, rear, 4-door, W4	52.8 in.	(1340 mm.)
Luggage space (SAE)	12.2 cu. ft.	(347 l.)
Trunk volume, total	23.3 cu. ft.	(660 l.)

WEIGHTS	2-door manual	4-door manual	2-door automatic	4-door automatic
Curb weight ¹⁾	2480 lb.	2550 lb.	2510 lb.	2580 lb.
Max. loaded vehicle weight	3440 lb.	3510 lb.	3440 lb.	3510 lb.

¹⁾ For factory-installed air condition, add 70 lb.

ENGINE	99E
Cylinders	4 in line
Piston displacement	113.1 cu. in. (1854 c.c.)
Bore	3.42 in. (87 mm.)
Stroke	3.07 in. (78 mm.)
Compression ratio	9.0:1
Net horsepower (SAE)	95 b.h.p. at 5200 r.p.m.
Torque	106 lb. ft. at 3200 r.p.m.
Cylinder block	cast iron
Cylinder head	aluminum alloy
Camshaft	overhead (chain drive)
Number of main bearings	5
Fuel injection	electronically controlled
Battery	12 volt, 60 Ah.
Alternator	55 A.
Cooling fan	electric, thermostat-controlled
Cooling system capacity	9 quarts
Fuel tank capacity	11.9 gals.

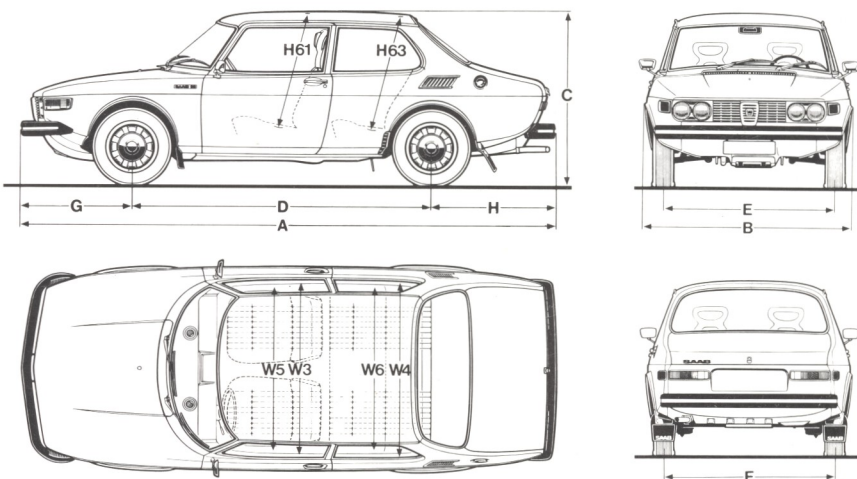

TRANSMISSIONS	manual	automatic
Driving wheels	front wheels	front wheels
Clutch	single dry plate	hydr. torque converter
Primary gear ratio	0.95:1	1.09:1
Number of forward gears	4	3
Overall ratios, vs. torque multiplication:		
1st	13.59:1	18.92 - 9.90
2nd	8.63:1	18.92 - 6.01
3rd	5.80:1	18.92 - 4.15
4th	4.00:1	-
reverse	13.63:1	16.55 - 8.66
Final drive ratio	4.22:1	3.82:1
Top gearspeed at 1000 r.p.m.	17.7 m.p.h.	-

BRAKES, STEERING, SUSPENSION, WHEELS	
Footbrake system	dual circuit; vacuum servo
Wheel brakes, front and rear	Self-adjusting disc brakes
Total friction area	358 sq. in. (2310 cm ² .)
Handbrake	drums on front wheels
Steering gear	rack and pinion
Steering wheel turns, lock to lock	3.5
Turning circle diameter	34 ft. (10.4 m.)
Front suspension	transverse arms, coil springs
Rear suspension	rigid, tubular axle; coil springs
Shock absorbers	double-acting, telescopic
Rims	4.5J x 15 in.
Tires	radial ply, 155 - SR 15 in.

import motors inc.

Sales - Parts - Service

1685 Mentor Ave. Ph: 352-9625

Painesville, Ohio 44077

The manufacturer reserves the right to make changes at any time and without notice.

Distributed in U.S.A. by Saab Motors, Inc., N.Y., New Haven, Conn., Jacksonville, Fla., Torrance, Calif., and Saab Southwest, Inc., Denver, Col. and Grand Prairie, Texas.

SAAB-SCANIA

Automotive Group

Södertälje and Trollhättan, Sweden