



VOLVO S60

www.volvocars.us

S60



There's more to you than a new car. There's the courage to dare. There's the curiosity to explore. There's the thirst for passion and the hunger for excitement. There's the hunt for experiences that are unique and for emotions that take you to thrilling places. That's what the stunning Volvo S60 does. That's why you drive one.









SEXY. VOLVO. SAME SENTENCE.

Introducing the first Volvo to freely inspire the use of adjectives and superlatives rarely mentioned by those not on the payroll. A masterwork of automotive design, Volvo S60 is so beautiful that we suppose pedestrians could be stunned when they first see it. So we invented a safety system for them – a world first. But make no mistake. This is a driver's car. It moves like no Volvo before. Too sexy to be the safest car ever? We can live with that.

A FIRST-CLASS TRIBUTE TO PUNCTUALITY.

The advanced chassis developed for the Volvo S60 makes clear that this is no ordinary Volvo. Utilizing innovative new technology, we have further refined Volvo's Stability-enhancing DSTC system to help drivers better realize their intentions – with more assertion, efficiency and dare we say, more pure driving enjoyment. For example, the Advanced Stability Control feature monitors the car's behavior with high precision – making micro-adjustments with maximum speed – to further enhance stability in sharp curves and with rapid lateral movements. Corner Traction Control through torque vectoring also helps your car pivot around bends with more grace by braking the inner wheel and redistributing engine torque to the outside wheel. It also improves acceleration when turning onto a road with faster traffic. And if you want even more driving dynamics, just activate the DSTC Sport Mode via Volvo Sensus and anti-skid becomes pro-fun.





HORSEPOWER AND ALL WHEEL DRIVE, A MATCH MADE IN SWEDEN

Engineered into every Volvo is the power to avoid trouble and the structure to minimize harm. The engine in your Volvo is also an excellent representative of this philosophy. Fact is, every Volvo engine is built to do more with less: respond instantly, with plenty of torque, throughout its entire rev range and do so using less fuel.

The Volvo S60 offers you three engine choices. In the T5, the powerfully efficient 2.5 liter five-cylinder turbocharged engine provides 250 horsepower, 266 ft/lb of torque (plus a maximum over-boost to 295 ft-lb). The 3.0 liter twin-scroll turbocharged engine in the T6, provides a fuel efficient 300 horsepower, 325 ft/lb of torque and for the ultimate Swedish performance experience – choose the iconic S60 T6 R-DESIGN tuned by Polestar Racing to deliver a stunning 325 hp and 354 lb/ft torque.

Now, with the T5 AWD model, All Wheel Drive is available on every S60*. Utilizing an electronically controlled AWD system from Haldex, the S60 now has the traction abilities to take on all variations of road and weather conditions. And on dry roads, the tractive abilities and precision handling from the AWD system help to lessen over-steer and under-steer conditions so you can enjoy the total driving experience. Even the Volvo K-PAX racing team believes AWD delivers an edge on the race track, particularly when it rains.

* Standard on T5 AWD, T6 and T6 R-DESIGN





DRIVER-FOCUSED DESIGN. ROAD-FOCUSED DRIVER. ALL-SYSTEMS GO.

The Volvo S60 makes no apologies for this drivers-oriented interior. The standard sport seats come with extra lateral-g support. In addition, the center console is angled to favor the driver's side and features the new driver control interface – Volvo Sensus. This intuitive computer command system uses a 7" hi-resolution color monitor and a scroll wheel selector on the steering wheel to make it easy to personalize settings and get the most from all of your on-board technology.

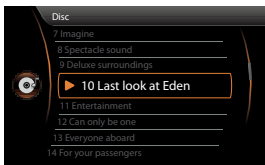

Playlists



Maps

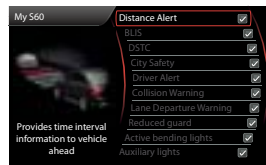

Personal settings



INNOVATIVE SAFETY FROM THE PEOPLE WHO WROTE THE BOOK.

It's no secret. Volvo makes its cars safer with innovations that lead the car industry. City Safety – standard in the S60 – is one of the most significant technological breakthroughs in collision avoidance and another Volvo world first. But no matter how many safety innovations and patents we have, the most important safety feature in any car is the driver, a well-informed driver. That's why Volvo has developed the Technology Package.

These innovative driver support systems engage, inform and involve drivers in a driving experience few would have thought possible 85 years ago – if it wasn't for our heritage of doing just that. Maybe that's why a well-informed driver drives a Volvo. To see this supportive technology in action, please visit www.volvocars.us

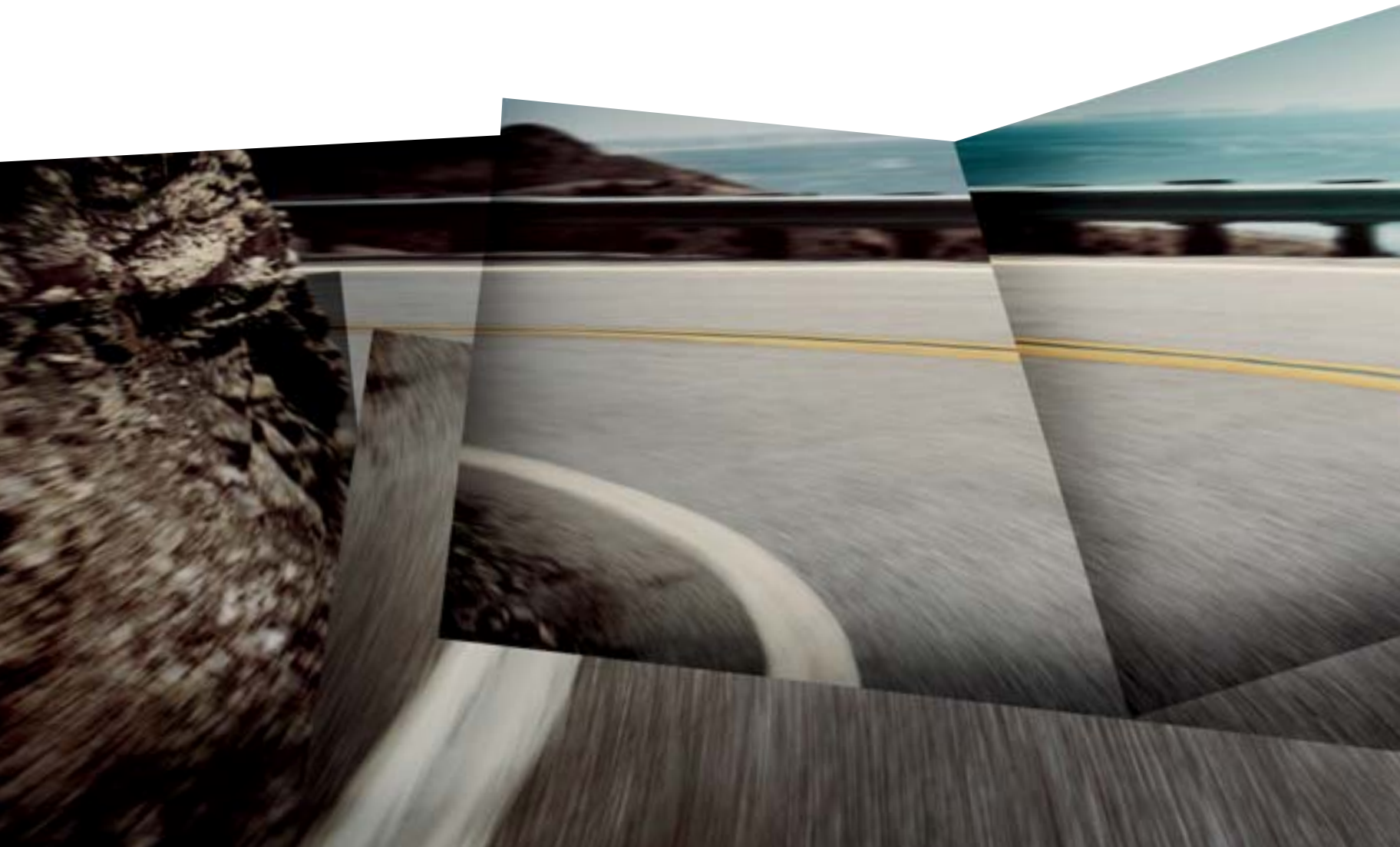



NOT THE FIRST SWEDISH BEAUTY THAT LIKES TO AVOID PEOPLE. BUT CERTAINLY THE FIRST CAR THAT CAN.

It is not likely, yet still possible, for a pedestrian to ignore your beautiful Volvo S60 and step into your path. Fortunately, the world's first pedestrian-avoidance technology is available now.

Using a digital camera and radar to constantly scan the road ahead, shapes identified as people at risk will trigger a warning. More importantly, the system will employ full brake force to stop your vehicle – if you don't. Our experts call it Pedestrian Detection with Full Auto brake*, but you can simply call it another Volvo safety world first.

* Included in the optional Technology Package









TECHNOLOGY WE LOVE:
**RADAR-GUIDED BRAKES THAT
HELP YOU GO FASTER.**

Adaptive Cruise Control (ACC) with queue assist*, goes beyond the basic accelerator management of ordinary cruise control by working with the advanced braking system. The interaction between your car's stop-quicker and go-faster functions managed by ACC – and informed by continuous input from its camera and radar scouts on point – helps you maintain a comfortable speed and a safe distance from vehicles ahead. And that's at any speed – whether in heavy traffic queues or at open-road speeds (0–124 mph). Having this additional functionality can help save you from the most boring parts of any journey. In this way, you can just sail through traffic.

* Included in the optional Technology Package



WHAT WE KNOW:

A REAR-END COLLISION IS NOT THE BEST WAY TO MEET PEOPLE.

With a goal to automatically eliminate the most common (and embarrassing) type of accident – the low-speed (below 31 mph) rear-end collision – Volvo created City Safety. This remarkable collision avoidance and mitigation technology – standard with the Volvo S60 – uses a closing-velocity laser sensor that tracks the car immediately ahead of you and constantly calculates how much braking force is needed to come to a full-stop before meeting them unintentionally. If the system senses an imminent exchange of personal information and insurance forms, it will automatically brake. Clearly, this technology can save you from more than embarrassment.





PROFESSIONAL DRIVER. FAVORITE TRACK. TESTING PREMIUM SOUND SYSTEM.

Every component of the Volvo S60 is thoroughly tested to meet the highest standards, with no detail is too small to perfect. For example, even the 650-watt Premium Sound system* – with MultEQ XT anti-distortion technology from Audyssey Laboratories, Class D digital amplification, 12 high-output speakers, a standard multi media DVD player and a high resolution 7" color screen – is tested to the limits to deliver inspiring performance. The Volvo S60 is one of a selected number of vehicles that offer such innovative technology for the sound system. MultEQ XT removes distortion caused by the cars cabin acoustics and provides crisp clear sound.

* Included in the Platinum trim level

S60 SHOWN WITH ACCESSORY
SPORT APPEARANCE PACKAGE



BEAUTIFUL ESCAPE. SAFE RETURN. REPEAT AS NEEDED.

As fun as the Volvo S60 is to drive, there are times when you'll have to park it. And leave it. One last glance over the shoulder offers some comfort, but having the right technology in hand could provide more security. Specifically, we recommend carrying an intelligent key fob, Volvo's Keyless Drive with Personal Car Communicator (PCC)*. With it, you can check the security status of your car from a distance and upon return, your Volvo lets you unlock doors with a grasp of a handle and start your car without a key in hand – it's enough to have the key in your pocket or handbag.

* Included in T5 Premier trim level, standard T6 and R-DESIGN





INNOVATED FOR YOUR ENJOYMENT, THE VOLVO SAFETY TECHNOLOGIES WILL PROTECT MORE THAN THE FUN OF DRIVING.

Across the world, Volvo equals safety. And that comes with good reason, because few carmakers can match our record of safety innovations and the commitment for safety that has guided us for more than 85 years. Of course, this makes us extremely proud. But we're not satisfied. Because we know what we want to achieve: zero accidents. This vision calls for innovative thinking and a brand new approach to the way we design cars. Good news is we've already come a long way. For starters, our cars are more fun and engaging to drive than ever (because a bored driver will never be a safe driver). Neither is the technology needed any figment of the imagination – some are already available. This means driving a Volvo today is like having a first peek at a very exciting automotive future – a future where passionate engineering and design do more to help you get the most out of life.

ADAPTIVE CRUISE CONTROL

Adaptive Cruise Control (ACC) with Queue Assist automatically maintains your set speed and distance to the vehicle ahead of you – whether you're driving on the highway or in slow moving stop and go traffic. Included in the optional Technology Package.



REAR PARK ASSIST CAMERA

The Rear Park Assist Camera lets you know what's going on behind your car when reversing. Included in the T5, T6 and R-Design® Platinum trim level.

BLIND SPOT INFORMATION SYSTEM

The optional Blind Spot Information System (BLIS) helps you detect vehicles entering your blind spot.

COLLISION WARNING WITH FULL AUTO BRAKE

Collision Warning with Full Auto Brake and Queue Assist warns if you're too close to a vehicle in front – at all speeds – and brakes the car automatically if a collision is imminent. Included in the optional Technology Package.

DYNAMIC STABILITY

Dynamic Stability and Traction Control (DSTC) improves handling, safety and fun in a wide range of challenging situations.

ROAD SIGN UPDATE

The Road Sign Information (RSI) displays speed limit signs in the driver information module to help keep you constantly updated on current limitations. Included in the optional Technology Package.

LANE DEPARTURE WARNING

Lane Departure Warning (LDW) warns you if you begin to drift between the lanes. Included in the optional Technology Package.

DRIVER ALERT

Driver Alert Control (DAC) alerts you if you begin to lose concentration and need a break. Included in the optional Technology Package.

ON-ROAD ENLIGHTENMENT

Active Dual Xenon headlamps expands your vision range when driving in the dark and provides considerably improved illumination around bends. With Active High Beam (AHB)*, your Volvo will recognize the headlight beam of on-coming vehicles and automatically adapt your beam to give you maximum vision without dazzling other drivers. Active Dual Xenon headlights with ABL are included in the T5 and T6 Premier Plus and Platinum trim levels, standard on R-DESIGN.

* Included in the optional Technology Package

PEDESTRIAN DETECTION WITH FULL AUTO BRAKE

Using radar and camera technology, this world's first Pedestrian Detection with Full Auto Brake can also detect pedestrians in front of your car and brake automatically if needed. Included in the optional Technology Package.

CITY SAFETY

City Safety – the world's first standard-fitted collision avoidance and mitigation technology – brakes your car automatically if you're about to run into a slower moving or standstill vehicle at speeds up to 31 mph.



DESIGNED TO CATCH THE LIGHT BRILLIANTLY, THIS CAR ALSO REFLECTS A PROMISE.

Thankfully, the automotive industry is moving away from fantasyland to the real world. Our journey towards a better environment started already in the early 70's. Then we were among the first carmakers to acknowledge the environmental downside of cars and to do something about it. Since then we are constantly innovating to reduce the environmental impact of the cars and how we make them.

We're introducing new technology such as plug-in hybrid vehicles that will further reduce CO₂ emissions and can be charged from a standard wall socket. And we're heavily engaged in the development of electrical vehicles – a technology that will dramatically reduce the environmental footprint of our cars and make them even more fun to drive.

Good for you, and for the world we share.

85% RECYCLABLE.

To help minimize its total environmental impact, every Volvo is designed to facilitate recovery and recycling at the end of its useful life.

CLEANER EXHAUST.

Fast responding after a cold start, Volvo's advanced emission control eliminates between 95 and 99% of carbon monoxide, hydrocarbons and nitrogen oxides from petrol engine exhaust gases. All engines comply with stringent emission requirements.

SAFER INTERIOR MATERIALS.

All our upholsteries and interior textiles are tested for certain allergy-inducing or harmful substances. And several interior metal details are tested with regard to contact allergies. Good for you, and for anyone who shares your ride.

FUEL-SAVING DESIGN.

To reduce energy-losses from wind and roll resistance, we utilize advanced aerodynamic design, light-weight materials and low friction technology. Together with state-of-the-art engine technology, this lowers your CO₂ emissions and helps you travel further on fuel.

CLEAN COLORS.

To reduce usage of environmentally hazardous solvents, all Volvo exterior colors are water-based. What's more, our painting facilities are among the cleanest in the world.

FRESH CABIN AIR.

Continuously monitoring incoming air and shutting out carbon monoxide, ground-level ozone and nitrogen dioxide, Volvo's available Interior Air Quality System helps ensure that the air you breathe in the car is cleaner than that outside when driving in heavy city traffic.



MINIMUM DRAG.

Born in Volvo's state-of-the-art wind tunnel, the S60 cuts flawlessly through air. For example, flat under body panels allow the air to flow more freely and contribute to lower fuel consumption.

BRAKE FOR ENERGY.

Everytime you brake, the battery is fed with extra power. Smart and fuel-saving.



WANT A DYNAMIC TOUCH?

Be one with your S60. Your body is held firmly yet comfortably in place by the Beechwood leather sports seats. The leather-clad sport steering wheel with Silk Metal inlay and leather-clad gear-knob are moulded to fit in your hands. The watch-dial gauges give you instant and vital information. Shimmer Graphite aluminum center stack adds to a distinctive air of sportiness. So if stylish and sporty looks set your pulse racing, this may be the Volvo S60 for you. Here shown as a T6 AWD in Black Stone with standard Sleipner 18" aluminum wheels and accessory rear spoiler.



OR SOPHISTICATED STYLE?

Soothe your senses surrounded by meticulously crafted sports seats upholstered in Soft Beige leather. State-of-the-art technology is within easy reach in the center stack, featuring authentic Urbane Wood for an unmistakable Scandinavian flair. Elegant from inside and out, this Volvo S60 T5 is painted in Flamenco Red Metallic and features optional Njord 17" aluminum wheels.

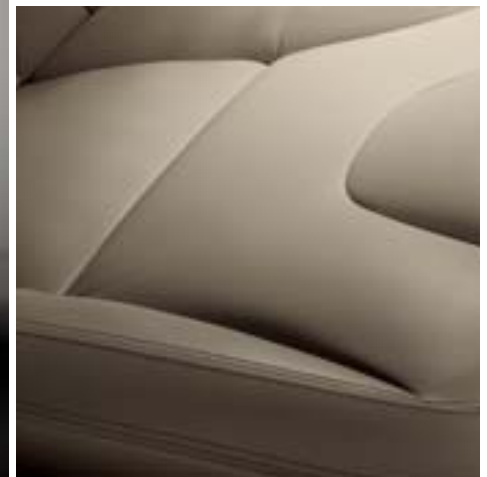



INTRODUCING THE MOST POWERFUL PRODUCTION VOLVO EVER.

Choose the Volvo S60 T6 R-DESIGN and receive a first class attitude adjustment. The advantage begins with interior and exterior styling that distinguishes all R-DESIGNS. Inside, R-DESIGN treatment surrounds the occupants in specially designed sport seats, upholstery and special accents – like the iconic blue watch dial instrument cluster. Aggressive front bumper and lower air intake, wheels and rear styling elements will ensure this Volvo means business.

The advantage accelerates, quite literally, with an increase of engine power to 325 hp and 354 lb/ft of torque utilizing Polestar engine performance tuning. Polestar Racing, a Swedish motorsport and performance products firm, has a long-standing racing partnership with Volvo. The result of this collaboration – an R-DESIGN with faster acceleration from the most powerful production Volvo ever.

And it's in the turns where the advanced Sport Chassis really makes a difference. Volvo engineers developed a unique suspension with damping, springs and anti-roll bars that are specifically tuned for quicker response and road hugging control. In addition, larger front rotors contribute to better brake performance. Dynamically expressive, the Sport Chassis amplifies the swift agility and complete control of the R-DESIGN to your advantage.

More Power. More Performance. More R-DESIGN.



R DESIGN





**THERE ARE TIMES IN LIFE
WHEN YOU HAVE TO TURN
UP THE VOLUME.**

The S60 T6 R-DESIGN dials up the physical and emotional dynamics beautifully. Outstanding R-DESIGN elements include the 18" IXION Diamond cut aluminum wheels, specially designed and stitched R-DESIGN sport seats, and an exclusive leather-clad, 3-spoke steering wheel with an R-DESIGN logo. Blue watch-dial accents also give you a pleasant reminder that you're driving something special every time you check the speedometer and rev counter.



Sport gearshift knob

Perforated leather and unique stitching gives the R-DESIGN gearshift knob a performance-ready look and feel.

Sport pedals

Racetrack-inspired to enhance the driving experience – enjoy the feel of these ridged sport pedals.



R-DESIGN upholstery

Enjoy the unique Offblack leather upholstered seats with contrast stitching. (3Z21)

R-DESIGN aluminum inlay

The center stack's aluminum inlay conveys a contemporary feel, enhances the overall modern Scandinavian design and sets the tone for sports.



Sport floor mats

Exclusive, hand-tufted sport mats with accent ribbing provide a stylish welcome.

STANDARD FEATURES

VALUE	T6 AWD R-DESIGN	T6 AWD	T5
Complimentary Factory Scheduled Maintenance for 5 years, 50,000 miles	●	●	●
SAFETY			
3 step airbag, drivers/passenger side	●	●	●
City Safety	●	●	●
Emergency Brake Assist (EBA)	●	●	●
Emergency brake light, extended light area	●	●	●
High positioned rear brake lights	●	●	●
Headlight washers	●	●	●
Height adjusted front seat belts	●	●	●
Inflatable curtains (IC)	●	●	●
Intelligent Driver Information System (IDIS)	●	●	●
Isofix – outer position rear seat	●	●	●
Passenger airbag	●	●	●
Pyrotechnical pretensioners, all seating	●	●	●
Rain Sensor	●	●	●
Rear belt detection, left, right & middle belts	●	●	●
Seat belt reminder	●	●	●
SIPS airbags	●	●	●
Whiplash Protection System front seats (WHIPS)	●	●	●
INTERIOR			
8-way power seat driver with 3 position memory for seat and exterior mirrors	●	●	●
60/40 split folding rear seat	●	●	●
Alarm	●	●	●
Approach light	●	●	●
Audio controls in steering wheel	●	●	●
Auto up/down power windows, all doors	●	●	●
Automatically dimmed inner mirror + digital compass	●	T	T
Auxiliary audio input (AUX connector)	●	●	●
Bluetooth® handsfree and streaming audio	●	●	●
Electrical heated rear window	●	●	●
Electrically folding rear headrests	●	●	●
Electronic Climate Control (ECC)	●	●	●
Flat folding front passenger seat	●	●	●
Front cupholders in tunnel console	●	●	●
HD Radio	●	●	●
Height/length adjustable steering wheel	●	●	●
High Performance Audio System	●	●	●
Home safe lightning	●	●	●
Homelink	●	T	T
Illuminated vanity mirrors	●	●	●
Key integrated remote control, central locking	●	●	●

	T6 AWD R-DESIGN	T6 AWD	T5
Leather gear shift knob	●	●	●
Leather seating surfaces	●	●	T
Manually adjustable passengers seat, 4 way with foldable backrest	N/A	N/A	●
Pollen filter	●	●	●
Private locking, trunk	●	●	●
R-DESIGN steering wheel	●	N/A	N/A
Rear armrest with cupholders and storage	●	●	●
Shimmer Graphite aluminum inlays	N/A	●	●
Sirius Satellite radio includes 6 month subscription	●	●	●
Sport leather steering wheel, with Silk Metal inlays, 3 spoke	N/A	●	●
Sport Seating	●	●	●
Storage in front of the center console	●	●	●
T-Tec Textile seating surfaces with sport seats	N/A	N/A	●
Trip computer, extended with speed display	●	●	●
Trunk entrapment release	●	●	●
USB & IPOD® Connection	●	●	●
Volvo Sensus with 7 inch high resolution color screen	●	●	●
Watch dial instrumentation	●	●	●
EXTERIOR			
17" Balder Alloy Wheels	N/A	N/A	●
18" Ixion Alloy Wheels	●	N/A	N/A
18" Sleipner Alloy Wheels	N/A	●	○
250 hp turbocharged 5 cyl engine	N/A	N/A	●
300 hp turbocharged 6 cyl engine	N/A	●	N/A
325 hp turbocharged 6 cyl engine	●	N/A	N/A
6-speed Geartronic Automatic transmission with Sport Mode	●	●	●
Active Dual Xenon headlamps	●	T	T
Advanced Stability Control	●	●	●
Antilock Brake System (ABS)	●	●	●
AWD with Instant Traction	●	●	○
Bright work decor, front spoiler	N/A	●	●
Brightwork on side windows, upper + lower	N/A	●	●
Corner Traction Control through Torque Vectoring	●	●	●
Day running lights (dimmed dipped headlights)	●	●	●
Dynamic Chassis	N/A	●	N/A
Dynamic Stability Traction Control (DSTC) with sport-mode	●	●	●
Electrical parking brake with drive away release	●	●	●
Halogen head lights	●	●	●
Heated and electrical adjustable outer mirrors	●	●	●
Keyless Drive Personal Car Communicator	●	●	T
LED tail lamps	●	●	●

	T6 AWD R-DESIGN	T6 AWD	T5
Polished tailpipes	●	●	●
Puddle light	●	●	●
Rear foglight auto-off	●	●	●
Sport chassis	●	N/A	N/A
Tire Pressure Monitoring System (TPMS)	●	●	●
Touring chassis	N/A	N/A	●

 The Bluetooth word mark and logos are owned by the Bluetooth SIG, Inc. and any use of such marks by Volvo Car Corporation is under license. Other trademarks and trade names are those of their respective owners.



S60 TRIM LEVEL:

PREMIER

(T5 only, standard T6 and R-DESIGN)

Power Glass Moonroof
Leather Seating Surfaces
Power Passenger Seat
Keyless Drive with Personal Car Communicator
Auto Dimming Rear View Mirror
Accessory Prep Cable

PREMIER PLUS

Active Dual Xenon Headlights
Park Assist, Front & Rear
HomeLink Integrated Garage Door Opener
Digital Compass
Power Glass Moonroof
Leather Seating Surfaces
Power Passenger Seat
Keyless Drive with Personal Car Communicator
Auto Dimming Rear View Mirror
Accessory Prep Cable (T6 only)

PLATINUM

Navigation System with Voice Control and Map Care
Volvo Premium Sound System
Rear Park Camera
Active Dual Xenon Headlights
Park Assist, Front & Rear
HomeLink Integrated Garage Door Opener
Digital Compass
Power Glass Moonroof
Leather Seating Surfaces
Power Passenger Seat
Keyless Drive with Personal Car Communicator
Auto Dimming Rear View Mirror

OPTIONAL PACKAGES:

CLIMATE PACKAGE

Heated front seats
Heated windshield washer nozzles
IAQS (Interior Air Quality System)

TECHNOLOGY PACKAGE

Adaptive Cruise Control with Queue Assist
Collision Warning with Full Auto Brake
Pedestrian Detection with Full Auto Brake
Lane Departure Warning
Driver Alert Control
Distance Alert Driver Alert Control
Active High Beam
Road Sign Information

INDIVIDUAL OPTIONS

	T6 AWD R-DESIGN	T6 AWD	T5
18" Ixion Alloys with Performance Summer Tires	○	N/A	N/A
18" Slepner Alloy wheels	N/A	●	○
17" Njord alloy wheel (no charge option T6)	N/A	○	○
AWD with Instant Traction	●	●	○
Blind Spot Information System (BLIS)	○	○	○
Four-C Active chassis	N/A	○	N/A
Front/Rear Park Assist	○	T	T
Heated Rear Seats (requires Climate Package)	○	○	○
Metallic paint	○	○	○
Urbane wood inlays	N/A	○	○

● = Standard ○ = Option T = Trim Level N/A = Not available







619 Rebel Blue
(only available for R-DESIGN)

498 Caspian Blue metallic

487 Ember Black metallic



492 Savile Grey metallic
(also available for R-DESIGN)



452 Black Sapphire Metallic
(only available for R-DESIGN)



019 Black Stone

COLOR YOUR VOLVO.

When it comes to the appearance of your Volvo, the choices of exterior color, wheels and other styling items are probably your most important design decisions. For more exterior styling options and to build your new Volvo online, please visit www.volvocars.us



614 Ice White
(also available for R-DESIGN)



477 Electric Silver Metallic
(also available for R-DESIGN)

Please note: It's not possible to reproduce exact original shades in printed matter. Please ask your dealer to show you samples.



612 Passion Red
(only available for R-DESIGN)

702 Flamenco Red metallic

704 Vibrant Copper metallic



SPORT APPEARANCE PACKAGE.

It's up to you. Add the Sport Appearance Package and any preconceptions about what defines pure passion are upgraded here. More assertive than conventional street wear, these exterior styling accents reflect a spirit of independence and a belief in personal freedom.

The exterior styling accessories includes a Sport Front Bumper accent, a Sport Rear Bumper accent with dual tail pipes, Sport Sill moldings, dual front Sport Decor frames (all in matt aluminum finish), Diamond Cut 18" Freja wheels and a color-coordinated rear spoiler. These assertive details accentuate the road-hungry stance of the Volvo S60.



EXTERIOR DESIGN

EXTERIOR DESIGN Aluminum wheels



Sleipner, 8x18", Silver Bright
(standard T6, optional T5)



Njord, 8x17", Silver Bright
(optional T6, T5)



Balder, 7x17", Silver Stone
(standard T5)

ACCESSORY Aluminum wheels



Freja, 8x18", Diamond Cut/Dark Grey Matt finish
(retailer installed accessory)



Freja, 8x18", Diamond cut/Light Grey finish
(retailer installed accessory)

INTERIOR DESIGN



Leather-clad Sport steering wheel, Charcoal with Silk Metal inlay



Leather-clad gearknob, Charcoal



Shimmer Graphite Aluminum trim (standard)



Urbane Wood (optional)



T-Tec/textile, Softbeige in Sandstone Beige interior, 3612, (Standard T5)



T-Tec/textile, Charcoal in Anthracite Black interior, 3601, (Standard T5)



Leather, Offblack in Anthracite Black interior, 3101
(Standard T6, T5 Premier Trim level)



Leather, Softbeige in Sandstone Beige interior, 3112
(Standard T6, T5 Premier Trim Level)



Leather, Beechwood/Offblack in Anthracite Black interior, 3103
(Standard T6, T5 Premier Trim Level)



Leather, Softbeige/Offblack in Anthracite Black interior, 3102
(Standard T6, T5 Premier Trim Level)

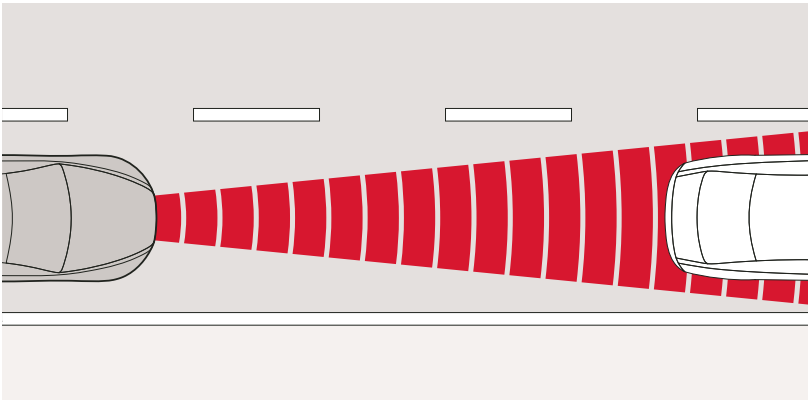

Adaptive Cruise Control (ACC) with Queue Assist and Distance Alert

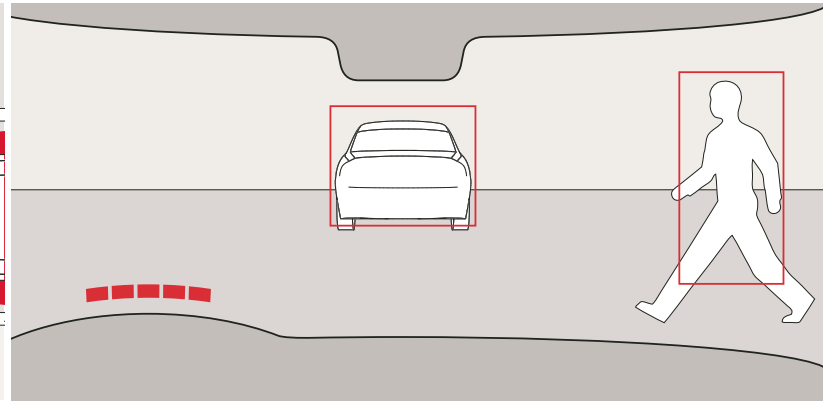

Collision Warning and Pedestrian Detection with Full Auto Brake



Driver Alert Control (DAC)

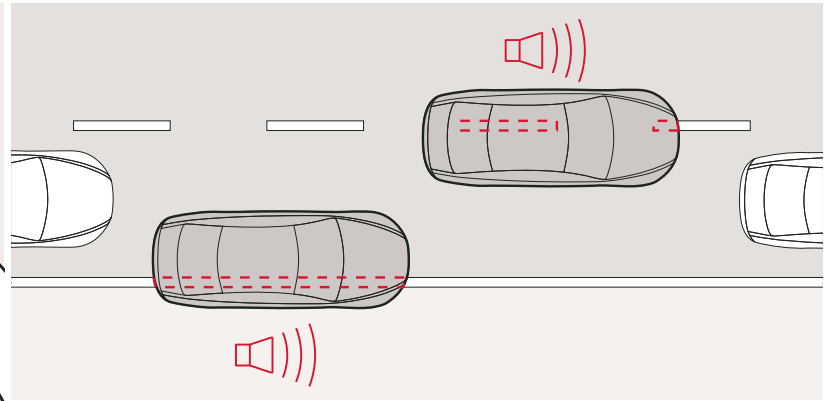

Lane Departure Warning (LDW)

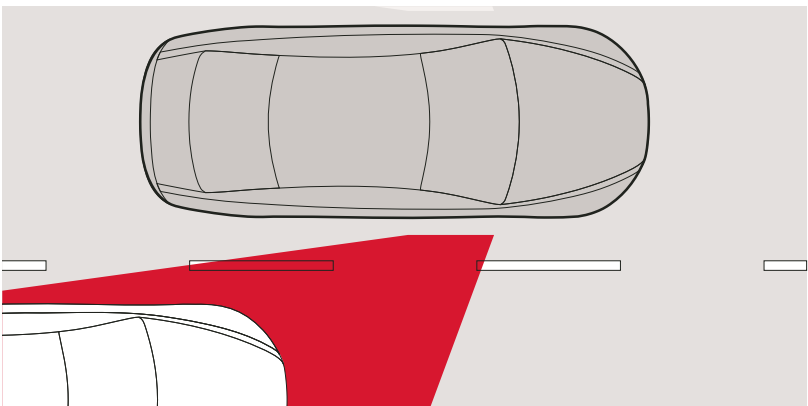

Blind Spot Information System (BLIS)

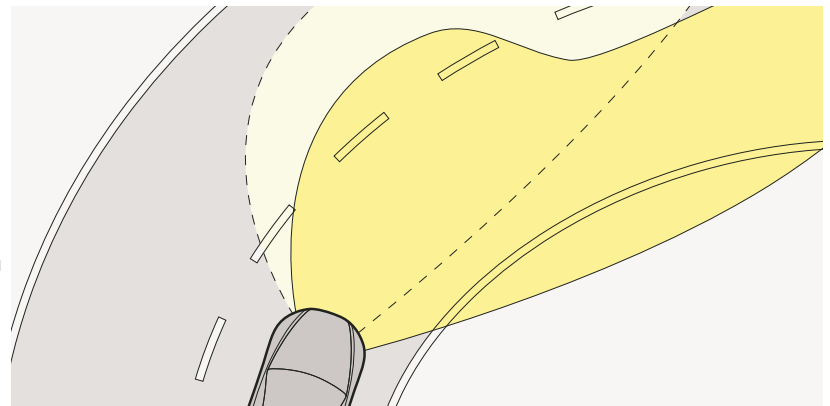

Active dual xenon headlamps

SAFETY

SAFETY Preventive

S60 Technology Package

Adding to both your safety margins and the driving experience, some of Volvo's most advanced safety driver's support innovations are available in this comprehensive package. Among many things, this includes groundbreaking technology to help avoid collisions, detect pedestrians and alert a distracted driver.

The Technology Package contains the following features: Adaptive Cruise Control (ACC) with Queue Assist and Distance Alert, Collision Warning and Pedestrian Detection with Full Auto Brake, Driver Alert Control (DAC), Lane Departure Warning (LDW), Road Sign Information (RSI), Active High Beam (AHB).

Adaptive Cruise Control (ACC) with Queue Assist and Distance Alert*

Helping the driver to keep a safe distance from vehicles in front at all speeds up to 125 mph, this third generation ACC is a supportive partner for a more relaxed driving experience on any journey. In slow moving city traffic up to 18 mph, the new Queue Assist function automatically adapts your speed to the vehicle in front. From standstill, a press of a button or the accelerator is all it takes to make your car smoothly tail the vehicle in front. At speeds over 18 mph, just select the desired speed and the minimum time gap to the vehicle in front. When the radar sensor detects a slower vehicle in front, the speed automatically adapts to that vehicle. And when the road is clear, the car resumes the selected speed. If ACC is disengaged and a vehicle in front comes too close, Distance Alert activates a red warning light in the lower section of the windscreen to help you keep a proper distance.

* Included in the optional Technology Package

Collision Warning and Pedestrian Detection with Full Auto Brake*

Statistics show that in 50% of the rear end collisions the causing driver doesn't brake at all. Active in all speeds above 2.5 mph, this third generation collision avoidance technology can warn you if you're too close to a vehicle in front or if there are pedestrians in your path. If you don't react and a collision is imminent, full auto-braking is engaged to help you avoid or mitigate an impact. Within a range of 500 feet, a radar sensor behind the grille and a digital camera behind the windscreen continuously monitor the distance to the vehicle driving in front of you. During daylight it can also detect standing or moving pedestrians. If a pedestrian unexpectedly steps out in front of your car or if a vehicle suddenly brakes (or is stationary) and Collision Warning senses that a collision is likely to happen, it

will alert you to act with a flashing red warning light on the windscreen along with an audible alarm. Moreover, this technology supports driver-initiated braking by pre-charging the brakes to quickly prepare for panic braking and help shorten the reaction time. If you don't react to the warning and a collision is imminent, the car immediately brakes with full braking force.

* Included in the optional Technology Package

Driver Alert Control (DAC)*

Up to 90% of all traffic accidents are caused by driver distraction. Driver Alert Control is a unique technology that can help alert a tired or distracted driver at speeds over 40 mph. Using signals from a digital camera to monitor the road ahead along with data from steering wheel movements, DAC can compare erratic behaviour to your normal driving style. A level indicator helps you keep an eye on your alertness status. If DAC detects that your driving behaviour shows signs of drowsiness or distraction, you receive an audible warning. At the same time, a message is displayed in the instrument panel suggesting it might be time for a break.

* Included in the optional Technology Package

Lane Departure Warning (LDW)*

At speeds over 40 mph, Lane Departure Warning can help prevent single-vehicle road departures as well as collisions caused by temporary distraction. This function uses the digital camera to register the lane markings and help monitor the car's position on the road. If you weave out of your lane, LDW will alert with an audible signal. If you intentionally cross a lane marker using the direction indicators, LDW is not activated.

* Included in the optional Technology Package

Road Sign Information (RSI)*

With RSI you don't have to miss important road signs. A forward camera detects speed limit and "no overtaking" signs. The actual sign is then displayed in the driver information module to help keep you constantly updated on current limitations. If you want, RSI can also alert with a visual warning if you exceed the speed limit.

* Included in the optional Technology Package

Active High Beam (AHB)*

Active High Beam enhances both convenience and safety when you drive in the dark. Employing camera technology, AHB recognizes the headlight beam of on-coming vehicles and automatically shifts between low and high beam to optimise your vision without dazzling other drivers.

* Included in the optional Technology Package

Blind Spot information System (BLIS) (optional)

BLIS uses rear-facing cameras installed in the door mirrors to keep a lookout on either side of the car. As a vehicle enters your blind spot, this function can alert you with a lamp built in to the front door post – left or right. Together with the door mirrors, this helps you assess the feasibility of a lane change. BLIS is activated once the car exceeds 6 mph, and reacts to almost any type of vehicle from a motorcycle upwards, day or night.

City Safety

City Safety collision avoidance technology is a Volvo world-first standard feature for safer urban driving. At speeds up to 31 mph, this laser-based technology can sense if a vehicle in front within 20-26 feet is at a standstill or is moving slower. If City Safety senses an impending collision, the brakes are pre-charged to act faster on your response. And if you don't brake, City Safety automatically applies the brakes and switches off the throttle to help mitigate the effects of a collision. And if the speed difference between your car and the vehicle in front is 9 mph or less, City Safety can even help you avoid a collision. City Safety is activated when you start the car.

Active dual xenon headlamps*

Compared to conventional halogen headlamps, Active Bending Lights use Dual Xenon technology to expand your vision range by about 230%. This means you'll be helped to gain 150 feet more for braking. And using motorised lamps that turn up to 15° in either direction, this technology gives a 90% boost to your vision round bends at night. You can enjoy highly effective low beam illumination on narrow, winding roads and extremely powerful full beams on the motorway. A daylight sensor disengages the adaptive function during daytime. Independent of the load, these headlights self-adjust to maintain the correct angle to the road – even during hard acceleration or braking.

* Included in T5 and T6 Premier Plus trim level.

Standard on R-DESIGN

Anti-locking brakes with Hydraulic Brake Assist (HBA) and Ready Alert Brakes (RAB)

Generously dimensioned anti-locking disc brakes and optimized hydraulics help to ensure a short stopping distance in all situations. Furthermore, they withstand tough use without fading. Hydraulic Brake Assist helps you use your brakes to the full in an emergency situation, while Ready Alert Brakes anticipate severe braking and prepare for it by moving the brake pads closer to the discs. Fading Brake Support automatically compensates for the higher pedal forces required after long periods of heavy braking. Electronic Brake Distribution distributes the braking effect between the front and rear wheels to achieve optimal results according to load and driving conditions.



Volvo's interactive safety technologies

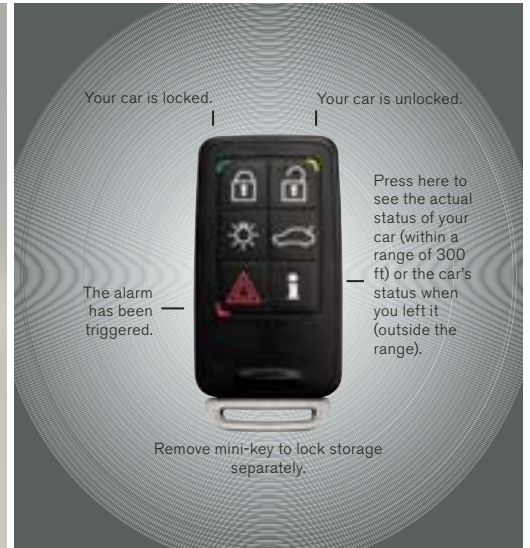

Keyless Drive with Personal Car Communicator (PCC)



Restraint technologies



Whiplash Protection System (WHIPS)



HomeLink®



**Power retractable door mirrors with ground lighting
(Retractable function only with BLIS option)**

SAFETY Protective

In a Volvo, safety is about interaction. Because it's not the number of safety features that determines how safe a car is. It's how well they seamlessly interact to help keep the occupants out of harm's way.

IN A **FRONTAL COLLISION** the patented frontal structure will yield to help absorb and disperse crash energy. The compact power train is designed to help optimise deformation. Inside the car, safety belts interact with the collapsible steering column and dual-stage airbags to help keep the occupants out of harm's way. Pre-prepared restraints – a unique Volvo technology – help optimise the various restraint systems for expected crash force.

IN A **ROLL-OVER** the robust safety cage and the reinforced roof structure together with the safety belts and belt pre-tensioners will help protect the occupants. If the car first has been hit from the side, the Inflatable Curtain (IC) deploys to help provide head protection.

IN A **SIDE IMPACT** Volvo's unique Side Impact Protection System (SIPS) helps distribute the crash forces across the car's body, away from the occupants. The side airbags in the front seats help protect the chest and hip, while the Inflatable Curtain (IC) adds head protection.

IN A **REAR IMPACT** the rear deformation zones will help absorb crash energy. The fuel tank is designed to remain well protected in front of the rear axle. The head restraints help protect the neck and spine, and Volvo's unique Whiplash Protection System (WHIPS) cradles the front seat occupants in a controlled manner to help prevent whiplash injuries.

Restraint technologies

In a collision, Volvo's restraint technologies interact to help reduce the impact. The safety belts with pre-tensioners activate within a few thousandths of a second in the event of a collision and tighten the belt to help keep the occupants securely restrained. The front seat safety belts then release a little so that the driver and passenger are cushioned by the airbags in a controlled manner. Helping to optimise protection, the dual-stage airbags adapt the level of inflation depending on the force of the collision. The driver's airbag also interacts with the deformation of the collapsible steering column.

Side airbags in the front seats help reduce the risk of serious injuries in a side collision. The Inflatable Curtain (IC) helps protect the heads of both front and rear outboard occupants. It also stays inflated for some seconds to provide prolonged protection for subsequent impacts.

Whiplash Protection System (WHIPS)

Integrated in the front seats, Volvo's WHIPS cradles the occupant to help reduce the risk of whiplash injury (one of the most common types of traffic injury and often the result of a low-speed rear impact collision). The function is activated by a collision of sufficient force from behind. Independent research has shown that WHIPS is one of the most effective systems in the world and can reduce the risk of long-term injuries by 50%.

Pre-prepared restraints

The restraint technologies of your Volvo are designed to help provide maximum protection while minimising strain on the occupants. Using new technology including a windscreen laser-sensor, this standard safety feature continuously monitors objects in front of the car at all speeds. This makes it possible to prepare and adapt the safety belts and airbags for expected crash force and thus help optimise protection in a low or mid-severe frontal collision.

Side Impact Protection System (SIPS)

SIPS is a Volvo unique safety system that has been developed to help protect where occupants are most exposed to the crash forces. The steel framework of the car – including the front seats – is designed and reinforced to help displace the impact of a side-collision away from the occupants to other parts of the car body and help prevent intrusion into the cabin. The extremely strong side structure contains ultra-high strength steel to help withstand a severe side impact – even with a larger vehicle. The Inflatable Curtain (IC) for all the outboard occupants and the front seat side airbags interact to help provide further protection.

Energy-absorbing frontal structure

In developing this Volvo's protective qualities, we have focused on frontal collisions at both higher speeds and with heavier vehicles. The patented frontal structure with its sizeable deformation zones in different kinds of steel will yield to help absorb crash energy. The compact power train is designed to help optimise deformation. The unique geometry of the frontal structure and longitudinal steel struts in the doors help disperse crash energy away from the front to the rear of the car, further helping to reduce the strain on the occupants. A steel cross-member under the dashboard further helps keep the cabin intact.

Pedestrian protection

To help reduce the risk of serious injuries on unprotected road-users, the front of the vehicle is gently rounded, the headlamps are integrated flush with the body, and the bonnet is energy-absorbing to act as a crumple zone.

SAFETY Security

Keyless Drive with Personal Car Communicator (PCC)*

PCC is an advanced remote control that combines keyless drive with two-way communication with your Volvo. Keep the PCC with you and the car unlocks automatically as you pull the door handle. Start the engine by pressing a button on the dash, lock the car by pressing a button in the door handle. Later in the day, if you're wondering whether you've locked the car, PCC can tell; no matter where you are. On your return to the car – within a radius of 197 to 328 feet – pressing the PCC information button will give you a current report on its lock and alarm status.

* Included in T5 Premier and Premier Plus trim level. Standard on T6 and R-DESIGN.

Private locking

Private Locking is a function that allows you to keep the luggage and glove compartment locked even when you lend out your key or Personal Car Communicator. To activate Private Locking, a miniature key incorporated within the remote control is used to lock the glove compartment and boot lid. This stops both compartments from being unlocked with the central locking remote control, but allows the central locking system and ignition to be used as normal.

Approach and Home Safe Lighting

Activated with the remote control or Personal Car Communicator, Approach Lighting provides a warm reception on a dark night. This consists of interior and side lights – ground lighting too, if you choose it. Home Safe Lighting is activated with the headlight stalk as you leave the car and it provides a similar courtesy when exiting your car. This feature includes a dipped beam from the headlight to accompany you to your door.

Power retractable door mirrors with ground lighting

At the touch of a button, these door mirrors can be folded flat against the car where they are less likely to get damaged after you've parked. They can also be set to fold or unfold automatically every time you lock or unlock the car. The integrated ground lighting is activated with the remote control or with the PCC. Beyond enhancing security to and from your car at night, this is also convenient when getting in and out (requires BLIS). And to facilitate parking, the door mirror on the passenger side can tilt automatically when reversing.

HomeLink®*

With buttons integrated in the sun visor, HomeLink® allows you to operate remote controlled home appliances – such as garage door, home alarm and exterior lighting – without leaving the car.

* Included in T5 and T6 Premier Plus trim level, standard on R-DESIGN

HomeLink is a registered trademark of Johnson Controls Technology Company.



Sport Seats



Power front seats



Electronic Climate Control (ECC)



Power glass moonroof



Front center armrest, multifunctional



Rear center armrest

SAFETY Security

Remote-controlled central locking

A touch of a button on the remote locks or unlocks the doors and trunk lid. Use the personal settings menu to decide if the remote unlocks the driver's door first or all doors together.

Automatic door locking

To further enhance your personal security, the doors can be set in the information menu to automatically lock the moment you drive away. Alternatively, lock them swiftly from the front seats using the lock button. Lock buttons are also available for the rear seat passengers.

Remote-controlled alarm

The alarm is connected to the doors, trunk, hood and ignition. It also reacts to movement inside the car or the breaking of a window. A level sensor can be added to deter thieves from jacking up the car and stealing your wheels. And in an emergency situation, the panic button on the remote control or on the PCC allows you to trigger the alarm for help.

COMFORT

COMFORT Sport seats

Power front Sport seats

Find your perfect driving position with push-button ease. The driver's seat also incorporates a memory function that stores three separate seat and door mirror settings connected to a specific remote control – a feature that's appreciated when the car has several drivers. A power passenger seat is standard on T6 and R-design and optional on T5.

Heated seats, front

Adjustable in three settings, heated seats for the driver and front seat passenger add to comfort on those cold mornings. Included in the optional Climate Package.

COMFORT Climate

Electronic Climate Control (ECC)

Electronic Climate Control (ECC) maintains the cabin temperature you choose and can be set independently for the driver and front passenger. Further contributing to your health and comfort, Volvo's unique humidity sensor helps ensure cabin air has an appropriate level of humidity according to the outside climate.

Interior Air Quality System (IAQS)

Volvo's IAQS continuously monitors incoming air and will, if necessary, temporarily close external air vents to shut out carbon monoxide, ground-level ozone and nitrogen dioxide. Meanwhile, an active carbon filter protects the occupants from other harmful gases and unpleasant odours. This helps to

ensure that the air you breathe in the car is cleaner than that outside when driving in heavy city traffic and tunnels. Included in the optional Climate Package.

Power glass sunroof

This makes the interior feel extra light and airy. It opens and closes at the touch of a button. If the sun is too strong, just close the built-in sunshade. The sunroof can also be closed together with the side windows using the central locking remote control. Included in the T5 Premier trim level, standard on T6 and R-DESIGN.

COMFORT Storage

Front center armrest, multifunctional

The central aisle of the cabin incorporates several facilities. Two cup holders are concealed by a roll-top cover. There's a handy storage space beneath the armrest, and special recesses for small items. Folding back the upper part of the armrest will provide a convenient table for the rear seat passengers. The armrest also features an AUX input and – depending on your choice of audio system – a USB port to connect your MP3/iPod® player to the car's audio system.

Rear center armrest

Folded down, the rear center armrest will increase comfort and provide the rear seat passengers with cup holders and smart storage.



Volvo Sensus



Rear Park Assist Camera



Front Blind View Camera



Volvo Navigation System



Bluetooth® handsfree system



Power foldable rear head restraints



Portable Navigation System

TECH & SOUND

TECH & SOUND Driver's Support

Volvo Sensus

Volvo's driver control interface allows you to conveniently explore the hi-tech features of your car and personalize them to suit your needs. All information is displayed in a high resolution 7-inch color screen. A push of the MY CAR button in the center console gives you access to all system settings like City Safety, ACC, Collision Warning, Pedestrian Detection, Driver Alert System, BLIS, light, door mirrors, climate, central locking and audio. The display also shows the RTI navigation system, phone, park assist camera and DVD. Everything is conveniently controlled using the ergonomic steering wheel controls – so you can keep your attention on the traffic and your hands on the steering wheel.

Park assist, rear and front*

Activated when you engage reverse gear, rear park assist helps you when reversing into tight spaces. The audio system is turned down and a pulsating sound from the rear loudspeakers becomes a continuous tone as you approach an obstacle. Front park assist performs a similar function at the front of the vehicle – alerting you via the front loudspeakers. The remaining distance is also shown on the audio display. Also available as a retailer installed accessory.

* Included in T5 and T6 Premier Plus trim level

Park assist camera*

To further improve your convenience when reversing, the Park Assist Camera helps display what's going on behind your car. The system uses the integrated driver's information screen and a digital camera discretely located over the license plate. On-screen guiding lines provide extra assistance for smooth parking. Also available as a retailer installed accessory.

* Included in the T5, T6 and R-DESIGN Platinum trim level

Front Blind View Camera*

Allowing you to see around corners, this new camera is located in the grille to give you a 180° field of vision of the area in front of your car. Activate the camera with a push of a button, and you'll get a split-image view in the 7-inch integrated driver's information screen. Very convenient in tight exits with limited visibility and while parking.

* Retailer installed accessory

Power foldable rear head restraints

Perfect for improving rear visibility when reversing, these are activated by the touch of a button from the driver's seat. The head restraints fold forwards so that rear-seat passengers notice and raise them again when entering the car.

Rain sensor with tunnel detection

Once activated, the rain sensor can start the windscreen wipers as soon as it begins to rain or if water splashes onto the windscreen. For your convenience, it can also automatically adapt the intermittent windscreen-wiper function. Its sensitivity can be adjusted via a ring on the wiper stalk. And as you enter a tunnel in daylight, the sensor will activate your car's headlamps and turn them off when exiting the tunnel.

Automatically dimmed inner rear-view mirror*

This is a mirror that automatically adjusts itself to deflect the headlamp beams of the car behind you. When there's no light to dazzle you, it automatically readjusts to its normal setting. This can be supplemented with an integrated compass.

* Standard on T6 and R-DESIGN, included in T5 Premier trim level.

Power parking brake

The Power Parking Brake (PPB) makes moving off from steep gradients easier. Once depressed, the PPB control lever automatically releases as the car pulls away.

TECH & SOUND Communication

Volvo Navigation System*

Volvo's navigation system is totally integrated with your car. It offers both voice guidance and graphic navigation all the way to your destination. Via TMC (Traffic Message Channel) radio data broadcasts also lets you know if there's weather-related trouble on route and recommends an alternative. The system utilizes the integrated full color high resolution 7-inch driver's information display and is easily controlled from the steering wheel – you can keep both hands on the steering wheel and your attention on traffic. You can also set your destination using voice control.

* Included in the Platinum trim level. Also available as a retailer installed accessory (requires accessory prep cable 000445)

Bluetooth® handsfree system with streaming audio

Bluetooth® technology enables a mobile phone to be connected to the infotainment system in your Volvo, wirelessly. Once configured for a mobile phone, the system automatically recognizes your phone as you enter the car. And as you climb in and out of the car, the system automatically allows you to switch freely from the phone to the handsfree system and back again. The audio systems High Performance Premium Sound include an integrated Bluetooth® handsfree system, allowing you to conveniently operate your phone using the buttons in the steering wheel or the center console keypad. Phone information is shown in the center console multi media display. And if you've chosen navigation system, you can make your calls using voice control. What's more, you can stream high quality audio from a media player and listen to it through the car's audio system.



® The Bluetooth word mark and logos are owned by the Bluetooth SIG, Inc. and any use of such marks by Volvo Car Corporation is under license. Other trademarks and trade names are those of their respective owners.

Portable navigation System*

Navigate with style and ease. This new ultra-thin versatile Garmin nüvi 3790 navigation unit integrates smoothly with the design of your Volvo. Just fit it into the docking unit at the windscreen pillar. Find the shortest, fastest or most fuel-saving route – voice recognition control and convenient multi-touch glass screen technology facilitates operation. Just keep your hands on the steering wheel and the system will act upon your spoken commands. Major buildings and points of interest are displayed in 3D to enhance your overview, and in junctions you're conveniently guided to the right lane at the right time. Using Traffic Message Channel (TMC) radio data technology, the navigation system will let you know if there are traffic disturbances on route and recommend an alternative. The system also features Bluetooth® handsfree phone technology and FM transmitter. And the navigation unit is easy to use outside the car – it even remembers where you parked your car. Maps covering major parts of Europe are stored in memory.

nüvi is a trademark of Garmin Ltd.

* Retailer installed accessory



Rear Seat entertainment (RSE) with dual DVD players

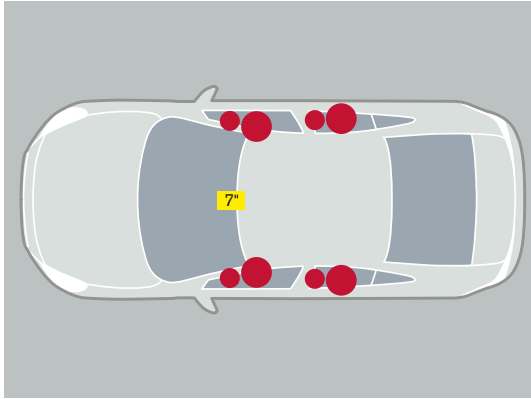

High Performance Multi Media system

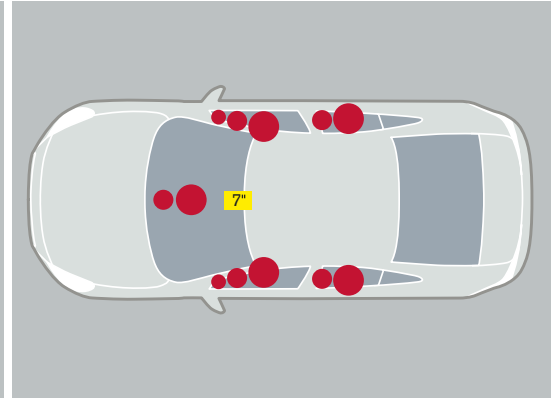

Premium Sound Multi Media system



SiriusXM Satellite Radio



SiriusXM Satellite Radio



Two-split 60/40 rear seat
Foldable front seat backrest



Luggage compartment mat, textile



Roof load carrying system

TECH & SOUND Audio/Entertainment

MP3 compatibility

There are a number of ways to enjoy MP3 music files in your Volvo. The CD player is compatible with various audio media formats. If you'd like to connect your personal MP3 player to the audio system, there's a standard auxiliary audio input in the front center armrest. Volume is conveniently controlled from the steering wheel, center console or rear seat audio console. There's also a USB port that allows you to fully integrate your iPod®, MP3 player or USB device with the audio system. Playlists, songs and artists are clearly displayed in the center console, while your player will be charged at the same time.

iPod is a trademark of Apple Computer Inc.

Rear Seat Entertainment (RSE) with dual DVD players

For more fun on long journeys, this easy-to-use system will entertain for hours. There are dual DVD players and dual 7-inch screens smartly integrated in the front head restraints. Each DVD player is conveniently operated by a rear seat passenger. The passengers can see the same movie or play the same game on both screens, or choose to view a film on one screen and play games on the other. Sound is provided via the car's audio system or wireless headphones.

High Performance system

This is a powerful and versatile 4x40 W audio system featuring advanced media technology such as Bluetooth® and USB/iPod® connectivity. Each of the 8 loudspeakers is fitted with a powerful magnet and a large coil. In combination with the amplifier, this system gives excellent transient reproduction and high power – simply superb sound. This audio level provides an full 7" integrated color screen. Bluetooth® with streaming audio and USB/iPod® connectivity further adds to the versatility of this system.

Premium Sound system

We designed this top-of-the line audio and infotainment system to give you a superior listening and communication experience. This 650 W system features twelve high-fidelity

loudspeakers and MultEQ sound processor technology by Audyssey Laboratories that optimises the sound reproduction for the interior acoustics. Dolby® Pro Logic® II surround sound helps tailor a well-balanced audio experience for each occupant. And to give you access to advanced in-car entertainment, communication and navigation technology, this system also connects with most media formats and players and features an integrated 7" screen.

Dolby, Pro Logic, and the double-D symbol are registered trademarks of Dolby Laboratories.

Premium Sound loudspeakers

The twelve high-end loudspeakers in the Premium Sound system are powered by a 5x130 W digital amplifier. There are three separate drivers – woofer, midrange and tweeter – in each front door. In the rear doors there is a similar set-up. Each speaker has its own crossover filter to harmonise with the others. The latest generation Dolby® Pro Logic® II surround sound uses the center loudspeakers (woofer and tweeter) and a sound processor to recreate authentic sound with a strong sense of presence for everyone in the car. The digital class D amplifier features new technology to provide extremely high efficiency, enabling it to generate the most audio power from the least amount of current.

SiriusXM Satellite Radio

Imagine driving along hearing the music you want, without having to flip through commercials, fumble with CDs or manage a playlist. Imagine hearing play-by-play action of your favorite team, no matter where you are. Or having channels and channels of comedy, talk, news, entertainment, family programming and more. Now Imagine having all of this, coast-to-coast, wherever you drive. This is the world of SiriusXM. Each Volvo equipped with Satellite radio includes a 6-month trial subscription to the "Sirius Select" package.



PACK & LOAD

PACK & LOAD Compartment

Split 60/40 rear seat

Ergonomically designed rear seats provide generous support for the body during long journeys. When a journey includes both cargo and passengers, just fold down part or all of the split rear seat.

Foldable front seat backrest

To help you carry long objects inside your Volvo, the front passenger seat backrest can be conveniently folded flat.

Net pockets

These three elastic net pockets provide practical storage for small items on the front passenger side of the tunnel console and along both side panels in the luggage compartment.

Luggage compartment mat, textile*

This elegant textile mat allows you to maintain the attractive appearance of the luggage compartment even if you occasionally transport dirty loads. Reversible and waterproof, with color-keyed textile on one side and plastic on the other.

* Retailer installed accessory

Rear seat cover*

To use the rear seat space as an extra loading area, there's a durable seat cover specially designed for your Volvo. Quickly fitted, this helps protect the upholstery if you need to carry a messy load. It's also useful if you need to collect a pet or a passenger wearing dirty clothes – safety belts remain operational.

* Retailer installed accessory

PACK & LOAD Carriers

Roof load carrying system*

To help you fully utilize the roof of your Volvo, we've developed a range of versatile load carrying accessories. This system is dimensioned to carry up to 220 lb. The factory-fitted attachment points in the car's roof make the load carriers easy to fit. Various load accessories – such as roof boxes and different holders for bikes, skis, surfboards and kayaks – can be attached to the load carriers to meet your needs. These accessories can be freely combined for flexibility and many are aerodynamically designed to help reduce fuel consumption and wind noise. And most of them can be locked with the same key, using Volvo's One-Key System.

* Retailer installed accessory

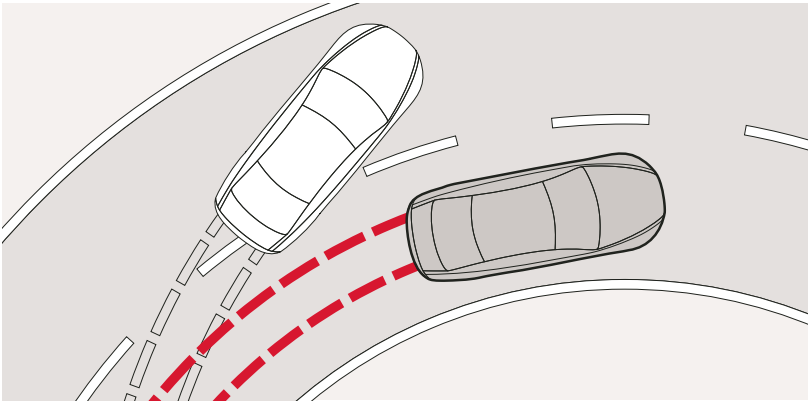

Dynamic Stability and Traction Control (DSTC)



**Four-C Active Chassis (Continuously Controlled Chassis Concept)
(Optional T6)**

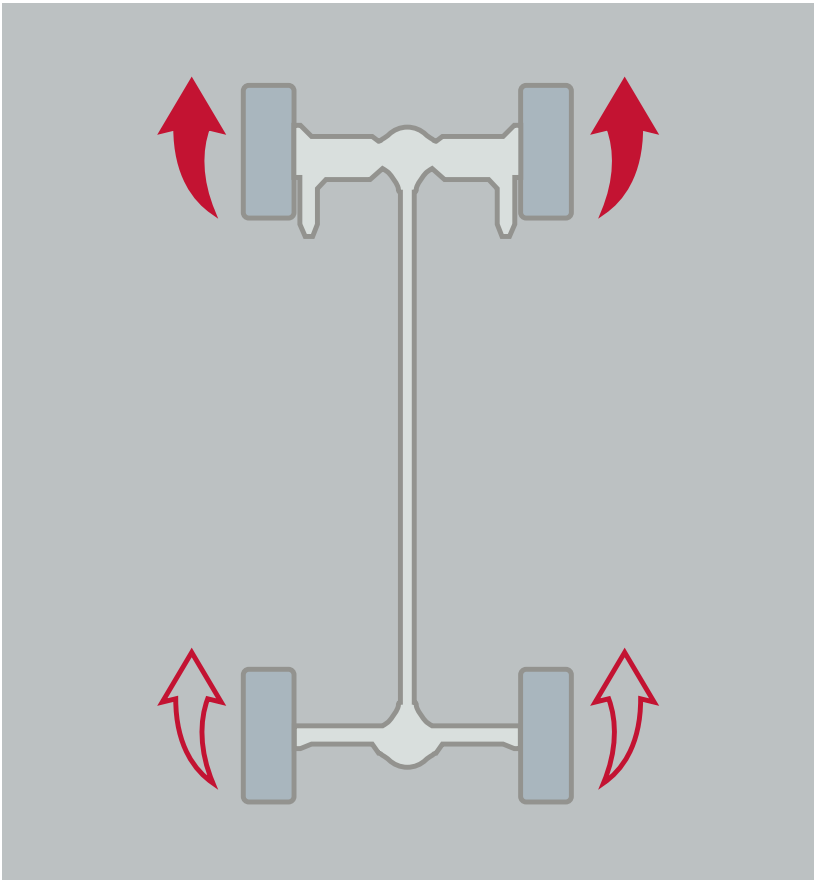

**All-wheel drive with Instant Traction™
(Standard T6 and T6 R-DESIGN, optional T5)**

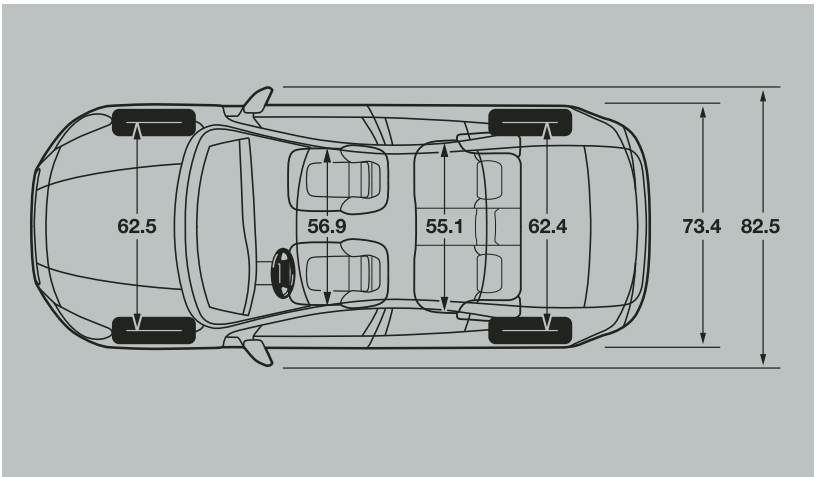
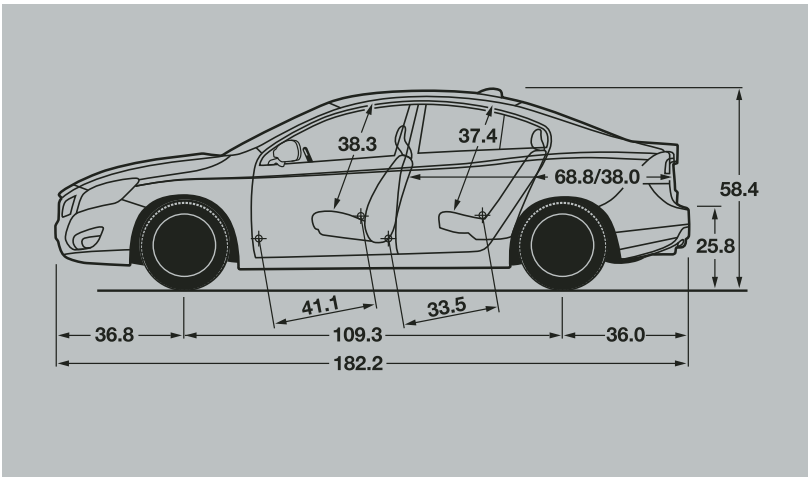

PERFORMANCE

PERFORMANCE Chassis/Steering

Dynamic Stability and Traction Control (DSTC) with Sport mode, Advanced stability control, traction control through torque Vectoring

By helping prevent spinouts and rollovers, stability control technology like DSTC has been described as one of the most vital safety advances of the past decade. And with the advanced features in this Volvo, it will probably also be perceived as one of the most important fun-to-drive innovations. At the core of DSTC, sensors register the car's direction and roll rate. The system compares this with steering wheel movements as well as the actual rotation of the car's wheels. DSTC is able to detect a potential skid and help counteract one by reducing the engine's power output, or braking on one or more wheels. It also prevents locking wheels caused by engine brake.

The new Advanced Stability Control function features a roll rate gyroscope and acceleration sensor to detect slowly built up skids at an early stage and compensate this with greater precision. As driver, you'll experience this as added stability in dynamic driving where the car is exposed to high lateral forces. Corner Traction Control with Torque Vectoring balances the torque between the front wheels during acceleration while cornering. This reduces understeer when cornering at higher speeds and makes the car even more dynamic – like when you turn onto a main road to catch up with the traffic flow.

Touring chassis (T5)

Volvo's chassis engineers spent thousands of hours on all kinds of roads to create a chassis that satisfies even the most demanding driver. Every single detail of the chassis is optimally tuned for sporty and well-balanced handling with a high level of comfort. For you as driver, advanced multi-link rear and McPherson spring strut front suspension mounted on a rigid body with a low center of gravity translate into a feeling of being in command and in safe control.

Dynamic Chassis (T6)

The Dynamic chassis includes revised bushings, dampers and sway bars that offer a higher level of vehicle response and driving enjoyment.

Four-C Active Chassis (Continuously Controlled Chassis Concept)*

The optional Four-C active chassis provides a choice of three distinctive driving modes – Comfort, Sport or Advanced. Whichever you choose, this technology monitors the car, road and driver 500 times per second, simultaneously adjusting each shock absorber to maintain optimal handling. At the heart of Four-C is Volvo's semi-active suspension with continuously controlled Monroe-Öhlins shock absorbers. Furthermore, Four-C interacts with the DSTC system, engine, brakes and steering to promote your chosen handling style.

* Optional on T6

Comfort This chassis mode isolates the car's occupants from irregularities in the road surface. This setting prioritizes flexible dampening for smooth and gentle body movement and exceptional comfort. It's ideal for slippery or uneven roads.

Sport For a sportier experience, this setting prioritizes slightly stiffer dampening and acts faster. This results in more decisive body movement, precise handling and good ride comfort. Perfect for active driving.

Advanced This is the high performance mode. This setting stiffens the shock absorbers for maximum road contact – directly communicating the road surface to the driver. Prioritizing immediate feedback rather than comfort, the advanced setting increases the range of driving dynamics.

Speed dependent steering*

Speed dependent and progressive power steering uses sophisticated, speed-sensitive technology to regulate the amount of power assistance a driver needs. At high-way speeds, steering is firmer and more immediate. When parking or in slow traffic, steering is light and effortless. There's a choice of three settings allowing you to choose a suitable level of road feel or steering sensitivity.

* Standard on T6

PERFORMANCE Transmission

Brake energy regeneration

To further optimize fuel efficiency and performance in all driving conditions, all engines feature Volvo's intelligent brake kinetic energy regeneration. As soon as you brake or release the accelerator while a gear is engaged, the alternator harnesses the car's kinetic energy and feeds it into the battery to reduce fuel consumption with an extra 2–3%. And when you accelerate, the alternator decouples to free the engine for maximum performance when you need it.

Six-speed Automatic Geartronic transmission with Sport Mode

The six-speed Geartronic offers three distinct settings that allow you to engage in the driving experience at different levels. Fully Automatic with adaptive shift logic, Sport Mode with sharper throttle response and higher RPM shift points and Geartronic which provides manual up/down shifting capabilities. In addition, a special Winter setting helps to move the car in slippery conditions like snow.

All-wheel drive with Instant Traction™*

The advanced Haldex AWD technology with Instant Traction™ helps increase driving stability and traction on all road surfaces. It has an electronic management system that constantly monitors the speed of the wheels, the throttle, engine torque, engine speed and the brakes. As driving conditions change, wheels with the best grip get the most power which helps to minimize oversteer and understeer for better chassis balance and handling.

* Standard on T6, T6 R-DESIGN, optional on T5.

PERFORMANCE Engines

T6 AWD, six-cylinder turbocharged engine 300 hp, 325 lb/ft torque T6 AWD 325 hp, 354 lb/ft torque T6 R-DESIGN AWD

This sporty in-line 3.0-liter six-cylinder engine meets high expectations for performance, comfort and environmental care. The twin-scroll turbo delivers immediate response at all revs. Fuel saving technology such as brake energy regeneration and reduced internal friction contribute to lower CO₂ emissions greater fuel economy and more power. This engine's compact design aids safety performance in a frontal collision. The latest generation of fast response emission control technology ensures that the engine complies with stringent environmental standards such as Euro 5/ULEV2. Acceleration: (0-60 T6: 5.8 sec, T6 R-Design: 5.5 sec)

T5, five-cylinder turbocharged engine (250 hp)

We designed this 2.5 liter five-cylinder turbo engine to maximize both performance and fuel economy. Matching perfectly with the sporty soul of the S60, this sophisticated power plant will take you from 0 to 60 mph in 6.4 seconds. And having access to an impressive 266 ft/lb of torque already from 1,800 revs (plus maximum over-boost to 295 lb/ ft), you'll accelerate effortlessly in a wide range of situations. Continuously Variable Valve Timing for both inlet and exhaust valves (dual CVVT) promotes a quick engine response and a continuous flow of power. Together with advanced emission control technology, the dual CVVT also contributes to cleaner exhaust emissions under all driving conditions.

TAKING CARE OF YOUR OWNERSHIP NEEDS.

VOLVO LEASING AND FINANCING OFFERS.

Special offers are available to finance or lease your new Volvo product. Whether you are looking for the convenience of a lease or the pride of owning your Volvo vehicle, our nationwide network of retailers and authorized financial service providers are ready to assist you with all your financing needs. please contact your local retailer for details.

On Call roadside assistance.

Whenever you need us, we're just a phone call away. Our nationwide network of retailers and authorized service providers are ready to assist. Whether you require roadside assistance or maps and routing information for your next trip, refer to your On Call Card and dial 1-800-63-VOLVO – anytime, day or night. Your complimentary four-year membership activates the moment you become a Volvo owner.

Volvo new car warranty.

Your new car warranty provides comprehensive coverage for five years or 50,000 miles, whichever occurs first. Additional warranties cover corrosion, seat belts, the supplemental restraint system, emission systems, genuine Volvo replacement parts and genuine Volvo accessories. Should you encounter any problem with your Volvo, simply contact the nearest retailer for assistance. Where your warranty ends, Volvo Increased Protection (VIP) plans begin. To purchase the additional protection of a VIP plan, contact your local retailer.

Complimentary Factory Scheduled Maintenance.

Volvo is committed to a premium ownership experience for its customers. To further enhance your ownership experience, all 2013 model year Volvo's sold in the united states will include Complimentary Factory scheduled maintenance. This program provides scheduled maintenance coverage for the first 5 years or 50,000 miles, is designed to compliment your Volvo warranty, and will help ensure trouble free operation of your Volvo. Coverage includes factory recommended maintenance including oil and filter changes, checks and adjustments as listed in your warranty and maintenance records Information booklet, for the first five maintenance services at intervals of 10,000, 20,000, 30,000, 40,000 and 50,000 miles.

Service must be performed within 1,500 miles before or after each scheduled interval. Coverage is limited to scheduled maintenance items listed in the 2013 model year Warranty and Maintenance Records Information booklet. An authorized retailer must perform maintenance. Offer is transferable. Optional Factory Scheduled Maintenance program upgrades are also available that will allow you to customize coverage to meet your driving needs. See your Volvo retailer for details.

Volvo service for life.

Taking the concept of service to a new level.

- Two-year Parts Warranty. Including the labor when they're installed at an authorized Volvo retailer

- Complimentary Software Updates during a scheduled maintenance visit. New software required as part of repair or accessory installation is not included
- Complimentary Vehicle Diagnostics if your Volvo has a "check engine" lamp or other warning indicator illuminated. Up to an hour of computer diagnostics
- Special discounted On Call Advantage Roadside Assistance pricing. Visit your retailer for enrollment form

Volvo mobility program.

The goal of the Volvo Mobility Program is to assist persons with physical disabilities or hearing impairment. For those with exceptional transportation needs, this can be facilitated within the extraordinary comfort and safety of a specially adapted Volvo. For additional information on this program, please contact the Volvo Mobility Program Headquarters at (800) 803-5222 or visit www.volvocars.us/mobility. TTY users are invited to call 1-800-833-0312.

Personal shopper.

The Volvo Personal Shopper is dedicated to providing you with a whole new level of shopping convenience. Whether you'd like help identifying the Volvo model that best fits your lifestyle, detailed information on any Volvo model, or a comparison against the competition, Volvo is there to help. We can arrange a Guest Drive for you at your nearest Volvo Retailer. So make the most of your shopping time and call the Volvo Personal Shopper at 1-800-550-5658. (U.S. only)

VOLVO OVERSEAS DELIVERY.

Volvo Overseas Delivery offers a unique way to buy your new custom-built car as well as a unique way to see more of Europe. And when you're done traveling, bring the pleasure of driving a Volvo back home. Purchase any new Volvo as part of the Volvo Overseas Delivery Program and enjoy all this – and more:

- Attractive pricing on US models.
- Access to colors and certain features normally only available in Europe.
- 15 days of international insurance and export registration included.
- Two complimentary round-trip tickets with Scandinavian Airlines (peak season surcharge may apply).
- One free hotel night in Gothenburg, Sweden, the home of Volvo.
- An exciting Volvo Factory Tour or a visit to the new Volvo Brand Experience Center.
- An exclusive VIP delivery experience at the Volvo Factory Delivery Center.
- The opportunity to explore Europe in the comfort and safety of your own Volvo, either with one of our spectacular tours or on your own.
- Extensive complimentary home shipment services. Just leave your car with us. We'll ship it to you the convenient way while you relax and enjoy your complimentary flight back home.

Can you think of a better way of traveling overseas and making your souvenir part of an unforgettable experience? If you would like to know more, contact your local Volvo retailer, our Customer Care Center (800) 631-1667, or visit www.volvocars.us/mybagsarepacked www.facebook.com/volvooverseasdelivery

VOLVO CARS MILITARY/DIPLOMAT/ EXPATRIATE SALES. FOR YOU LIVING ABROAD.

Sometimes life abroad offers exceptional benefits. Such as buying a new tailor-made Volvo on very special and rewarding terms. Whether you are traveling for pleasure or are in a professional, diplomatic or military post outside your home country, turn to Volvo for a great deal. For US Military personnel posted overseas our authorized military agents outside the US offer:

- Great savings compared with Stateside pricing.
- Professional assistance with all legal formalities and paperwork.
- Four-year warranty coverage also outside the US (US and Canadian specifications)
- US specifications – built to meet legal requirements in all US states.
- No US import duty with PCS orders, for US military personnel taking delivery overseas.
- Included shipping & Marine Insurance, delivery to an authorized Volvo retailer of your choice in the USA. US diplomats & military personnel stationed abroad for more than 140 days & non-US diplomats (depending on status) are normally exempted from customs import duty.
- Delivery to a Volvo military agent close to your base or assignment overseas.
- Five years valid Volvo Home Shipment from authorized drop-off points in Europe to an authorized US Volvo retailer of your choice included.
- More than 20 drop-off points in Europe.
- The option of VIP factory delivery in Sweden or delivery to selected major cities in Europe.
- The option of our special Cruise & Collect package with Stena Line ferries (German market).
- The benefit of the Volvo Assistance Europe scheme at no extra cost.

Taking advantage of the savings, benefits and convenience of Volvo's international programs is easy. Volvo Cars Military Sales, Volvo Cars Diplomat Sales and Volvo Cars Expatriate Sales are professional and global organizations with one goal – to make it advantageous and convenient for you to buy your new car when living abroad. www.military.volvocars.com www.diplomat.volvocars.com

While in the us, Military personnel with PCS orders, Diplomats & Expatriates please contact your local Volvo retailer, or our Customer Care Center (800) 631-1667 or visit www.volvocars.us/mybagsarepacked

WELCOME TO THE CLUB.

THE VOLVO S60 MERCHANDISE COLLECTION.

This smart collection of lifestyle accessories captures the driving spirit of your new Volvo and reflects the best of modern Scandinavian design. The signature items below are a select few. Find more keepsakes, gifts and apparel at your local Volvo showroom and at www.volvocars.us



Silver diamond tumbler



Fossil grey dial watch



Vintage crew sweatshirt



Portable speaker case



Barriga dome keyring



Workzone lunch cooler



Black barrel ceramic mug



Organic black T-shirt



VOLVO S60

Design the Volvo
that's really you at
www.volvocars.us



www.twitter.com/VolvoCarsUS



www.facebook.com/VolvoCarsUS



www.youtube.com/VolvoCarsUS

www.volvocars.us

Specifications, features, and equipment shown in this catalog are based upon the latest information available at the time of publication. Volvo Cars of North America, LLC reserves the right to make changes at any time, without notice, to colors, specifications, accessories, materials, and models. For additional information, please contact your authorized Volvo retailer. © 2012 Volvo Cars of North America, LLC. Printed in USA on 100% recyclable paper. **MY13C**

