



VOLVO XC60

www.volvocars.us

XC60



There's more here than just a beautiful car. There's a beautiful car that understands that self-fulfilment and the needs-of-others can be happy together. A car that rides high on competence so you can drive passionately with confidence. A car that helps avoid pedestrians in your path*, helps prevent low-speed fender-benders in city traffic and helps reduce high-speed game-enders* on the open road. A car that knows how to get the job done and how to keep the fun going. In other words, there's the Volvo XC60, a beautiful car that performs beautifully. That's why you drive one.

* Included in the optional Technology package





XC60 SHOWN WITH ACCESSORY FRONT BUMPER BAR AND SIDE SCUFF PLATES.





ONE LOOK AND YOU KNOW WHY LIGHT HAS TO TRAVEL SO FAST.

Beauty can't wait. And this Scandinavian beauty is going places in a hurry. To keep up with its dynamic design, athletic purpose and surprising agility, engineers at Volvo equipped this highly capable crossover with world first innovations. For example, Volvo's standard City Safety and available Pedestrian Detection* technologies can see road risks ahead and automatically employ full-force braking to help avoid the low-speed faux pas.

What's more, powerful six-cylinder engines (turbocharged in the T6 and R-DESIGN) – with a patented, hyper-efficient design – deliver an instant response with the high torque that Volvo engines are known for. But if being smart, swift and powerful isn't enough, there's the attractive beauty.

* Included in the optional Technology package





A COMMANDING VIEW JUST GOT BETTER.

After its superior ride height and curvy coupe design conspire to lure you inside, you'll find that the Volvo XC60 also provides one of the world's most seductive car interiors. select materials complement modern scandinavian design with genuine leather upholstery*, real wood inlays* and state-of-the-art technology readily available.

Take the wheel. The perfect driving position is easily found as Volvo seats are easy to adjust and easy to praise. What's more, the tilted center console favors the driver and features the Volvo Sensus driver-control interface on the built-in screen. The intuitive scroll selector on the steering wheel lets you easily access its menus to personalize settings and take command.

* Optional

TURBO-CHARGED FUN.

Performance is where innovation gets translated into fun. It's a complicated translation process, but it's safe to say Volvo's turbocharged six-cylinder engine plays a significant role in the T6 AWD. With its 300 horsepower, 325 lb/ft. of torque and ultra-low emissions, you'll find acceleration is instant, torque flows smoothly from gear to gear and fun translates to more fun as fuel goes farther. You can also enjoy the instant power of a sporty 3.2 liter six-cylinder engine with 240 hp and 236 ft-lb of fun-ready torque. Or for the ultimate Swedish performance experience – the iconic XC60 T6 R-DESIGN tuned by Polestar Racing to deliver a stunning 325 hp and 354 lb/ft torque.





HERE, YOU ARE ENTITLED TO KNOW EVERYTHING.

It's no secret. Volvo makes its cars safer with innovations that lead the car industry. City Safety – standard in the XC60 – is one of the most significant technological breakthroughs in collision avoidance and a Volvo Safety world first. But no matter how many safety innovations and patents we have, the most important safety feature in any car is the driver, a well-informed driver. That's why Volvo has developed the Technology Package and makes it available on the Volvo XC60.

The optional Technology Package includes enough intelligence-gathering equipment to earn code names for its components but their official names are proudly revealed here (opposite) with full disclosure. These innovative safety features engage, inform and involve drivers in a driving experience few would have thought possible 80 years ago – if it wasn't for our heritage of doing just that. Maybe that's why a well-informed driver drives a Volvo. To see this supportive technology in action, please visit www.volvocars.us



ACTIVE HIGH BEAM*

ADAPTIVE CRUISE CONTROL WITH
QUEUE ASSIST (AT ALL SPEEDS)*

* Included in the optional Technology Package



LANE DEPARTURE WARNING*

DRIVER ALERT CONTROL*

ROAD SIGN INFORMATION*

COLLISION WARNING WITH FULL AUTO
BRAKE AND PEDESTRIAN DETECTION*

BLIND SPOT INFORMATION SYSTEM
(OPTIONAL)



XC60 T6 AWD SHOWN WITH ACCESSORY FRONT BUMPER BAR AND SIDE SCUFF PLATES.



SAVING GRACE: TECHNOLOGY THAT SEES CLEARLY WHEN YOU CAN'T.

One split-second distraction is all it takes to realize how fortunate you are to be driving a Volvo. And now with Volvo's innovative Pedestrian Detection* and avoidance technology, your good fortune can also extend to unprotected pedestrians.

Using a digital camera and radar to constantly scan the road ahead, shapes identified as people at risk will trigger a warning. More importantly, the system will employ full braking force to stop your vehicle – if you don't. Our experts call it Pedestrian Safety with Full Auto Brake*, but you can simply call it another Volvo Safety world first.

* Included in the optional Technology package







TECHNOLOGY WE LOVE: A VISIONARY BRAKING SYSTEM THAT CAN SEE THE FUTURE.

Smart brakes mean confident cruising – at any speed. That's the aim of Volvo's Technology Package*. The core of the system, Adaptive Cruise Control (ACC) with Queue Assist (at all speeds), goes beyond the basic accelerator management of ordinary cruise control by working with the advanced braking system.

The interaction between your car's stop and go functions are managed by ACC – and informed by continuous input from its camera and radar scouts on point – helps you maintain a comfortable speed and a safe distance from vehicles ahead. And that's at any speed – whether in heavy traffic queues or at highway speeds (0–125 mph).

Having this additional functionality can help relieve you from the stop-and-go tedium of any journey. That way, you can just relax and enjoy the drive.

* Optional



**WHAT WE KNOW:
A REAR-END COLLISION IS NOT THE
BEST WAY TO MEET PEOPLE.**

With the goal of automatically eliminating the most common (and embarrassing) type of accident – the low-speed (below 31 mph) rear-end collision – Volvo created City Safety, this remarkable collision avoidance and mitigation technology – standard with the Volvo XC60 – uses a closing-velocity laser sensor that tracks the car immediately ahead of you and constantly calculates how much braking force is needed to come to a full stop before meeting them unintentionally. If the system senses an imminent collision, it will automatically brake. Clearly, this technology can save you from more than embarrassment. It can help reduce or avoid the impact of a collision.



XC60 SHOWN WITH ACCESSORY RUNNING BOARDS
AND REAR SKID PLATE.



A FORCE OF NATURE: THE PREMIUM SOUND MULTI MEDIA SYSTEM.

Nothing powers emotions like your favorite music. Play that music through any new Volvo sound system – fine-tuned for the interior acoustics of the Volvo XC60 with precisely matched components – and experience the natural splendor of world-class audio reproduction.

Take the top-of-the-line Premium Sound system* and the audiophile's choice is yours – all 650 watts of it. Driven by pure Class D digital amplification, with 12 high-output speakers and a Dolby® Pro Logic® II surround sound, this full kit is a credible force of nature and a discernible feat of engineering amusement. Crank it up.

* Included in the Platinum trim level







XC60 T6 AWD SHOWN WITH ACCESSORY TALITHA 20" ALLOY WHEELS, SIDE SCUFF PLATES AND REAR SKID PLATE.



BEAUTY SERVES A PURPOSE.

Sculpted beauty that she is, we build the Volvo XC60 to deliver more than just bold, buffed reflections. It's designed to perform, inside and out, with effortless pleasure. From the power tailgate* to the three-split rear seats that fold flat, great design reveals itself on a daily basis. Put it to work. This is a versatile beauty that performs beautifully.

* Included in the Premier Plus and Platinum trim level



HERE'S TO THE WATCHDOGS, THE GUARDIANS AND THE KEEPERS OF THE GATE (YOU KEEP IN YOUR POCKET).

From the ground up, the Volvo XC60 is built to be yours and stay yours. Personal security enhancements such as Approach and Home Safe Lighting and the Keyless Drive with Personal Car Communicator (PCC)* all make sure that you know Volvo safety is at work even when your car is at rest. With the PCC fob, you can check the status of your car from a distance, open locked doors automatically when you grab the handle, and start the car with keyless convenience – just have the fob in your pocket or handbag.

* Included in the Premier, Premier Plus and Platinum trim levels on 3.2. Standard on T6 and R-DESIGN.





INNOVATED FOR YOUR ENJOYMENT, THE VOLVO SAFETY TECHNOLOGIES WILL PROTECT MORE THAN THE FUN OF DRIVING.

Across the world, Volvo equals safety. And that comes with good reason, because few carmakers can match our record of safety innovations and the commitment for safety that has guided us for more than 85 years. Of course, this makes us extremely proud. But we're not satisfied. Because we know what we want to achieve: zero accidents. This vision calls for innovative thinking and a brand new approach to the way we design cars. Good news is we've already come a long way. For starters, our cars are more fun and engaging to drive than ever (because a bored driver will never be a safe driver). Neither is the technology needed any figment of the imagination – some are already available. This means driving a Volvo today is like having a first peek at a very exciting automotive future – a future where passionate engineering and design do more to help you get the most out of life.

KEEP THE BALANCE.

Roll Stability Control (RSC) senses an impending roll-over and helps stabilize the vehicle if needed.

STAY ON TRACK.

Dynamic Stability and Traction Control (DSTC) improves handling, safety and fun in a wide range of challenging situations.



ALL-ROAD STABILITY.

Volvo's available All-Wheel Drive (AWD) with Instant Traction™ enhances driving stability and traction in all weathers, all seasons and on all roads.

STAYING ALERT.

Driver Alert Control* alerts you if you begin to lose concentration and need a break.

URBAN COLLISION AVOIDANCE.

City Safety – the world's first standard-fitted collision avoidance and mitigation technology – brakes your car automatically if you're about to run into a slower moving or standstill vehicle at speeds up to 31 mph.

AN EYE ON THE BLIND SPOT.

The optional Blind Spot Information System (BLIS) helps you detect vehicles entering your blind spot.

POSITION CONTROL.

Lane Departure Warning* warns you if you begin to drift between the lanes.

ON-ROAD ENLIGHTENMENT.

Available Dual Xenon headlights with Active Bending light technology expands your vision range when driving in the dark and provides considerably improved illumination around bends. With Active High Beam (AHB), your Volvo will recognize the headlight beam of on-coming vehicles and automatically adapt your beam to give you maximum vision without dazzling other drivers.

ROAD SIGN UPDATE.

The Road Sign Information (RSI)* displays speed limits in the driver information module to help keep you constantly updated on current limitations.

KEEPING A SAFE DISTANCE.

Collision Warning with Auto Brake* warns if you're too close to a vehicle in front and helps brake the car automatically if a collision is imminent.

SMOOTH CRUISING.

Adaptive Cruise Control (ACC) with queue assist* maintains your set speed and distance to the vehicle ahead of you.

* Included in the optional Technology Package



DESIGNED TO CATCH THE LIGHT BRILLIANTLY, THIS CAR ALSO REFLECTS A PROMISE.

Thankfully, the automotive industry is moving away from fantasyland to the real world. Our journey towards a better environment started already in the early 70's. Then we were among the first carmakers to acknowledge the environmental downside of cars and to do something about it. Since then we are constantly innovating to reduce the environmental impact of the cars and how we make them.

We're introducing new technology such as plug-in hybrid vehicles that will further reduce CO₂ emissions and can be charged from a standard wall socket. And we're heavily engaged in the development of electrical vehicles – a technology that will dramatically reduce the environmental footprint of our cars and make them even more fun to drive.

Good for you, and for the world we share.



SAFER INTERIOR MATERIALS.

All our upholsteries and interior textiles are tested for certain allergy-inducing or harmful substances. And several interior metal details are tested with regard to contact allergies. Good for you, and for anyone who shares your ride.

RECYCLING.

To help minimize its total environmental impact, the Volvo XC60 already complies with proposed stringent European recycling directives.

FUEL-SAVING DESIGN.

To reduce energy-loss from wind and roll resistance, we utilize advanced aerodynamic design, light-weight materials and low-friction technology. Together with state-of-the-art engine technology, this lowers your CO₂ emissions and helps you travel further on fuel.

FRESH CABIN AIR.

Continuously monitoring incoming air and shutting out carbon monoxide, ground-level ozone and nitrogen dioxide, Volvo's optional Interior Air Quality System helps ensure that the air you breathe in the car is cleaner than that outside when driving in heavy city traffic.



WANT A DYNAMIC TOUCH?

If stylish and sporty looks get your pulse racing, this may be the Volvo XC60 for you: Leather Offblack upholstery in Anthracite Black interior with Brushed aluminum center stack, leather-clad steering wheel, with aluminum inlay and a leather-clad gear knob. Exterior color Ice White, accessory Achilles 19" Diamond cut/ Dark Grey matt aluminum alloy wheels. Shown with accessory running boards and front bumper bar.



OR MODERN LUXURY?

Some people prefer sophisticated, timeless elegance. If that sounds like you, your new Volvo XC60 3.2 can look like this: leather soft beige upholstery in Sandstone Beige interior with Wood inlay Accents plus accessory illuminated sill moldings. The exterior color is black stone with merac 18" Silver Bright aluminum alloy wheels.





INTRODUCING THE MOST POWERFUL PRODUCTION VOLVO EVER.

Choose the Volvo XC60 T6 R-DESIGN and receive a first class attitude adjustment. The advantage begins with interior and exterior styling that distinguishes all R-DESIGNS. Inside, R-DESIGN treatment surrounds the occupants in specially designed sport seats, upholstery and special accents – like the iconic blue watch dial instrument cluster. Aggressive front bumper and lower air intake, wheels and rear styling elements will ensure this Volvo means business.

The advantage accelerates, quite literally, with an increase of engine power to 325 hp and 354 lb/ft of torque utilizing Polestar engine performance tuning. Polestar Racing, a Swedish motorsport and performance products firm, has a long-standing racing partnership with Volvo. The result of this collaboration – an R-DESIGN with faster acceleration from the most powerful production Volvo ever.

And it's in the turns where the advanced Sport Chassis really makes a difference. Volvo engineers developed a unique suspension with damping, springs and anti-roll bars that are specifically tuned for quicker response and road hugging control. Dynamically expressive, the Sport Chassis amplifies the swift agility and complete control of the R-DESIGN to your advantage.

More Power. More Performance. More R-DESIGN.



R DESIGN



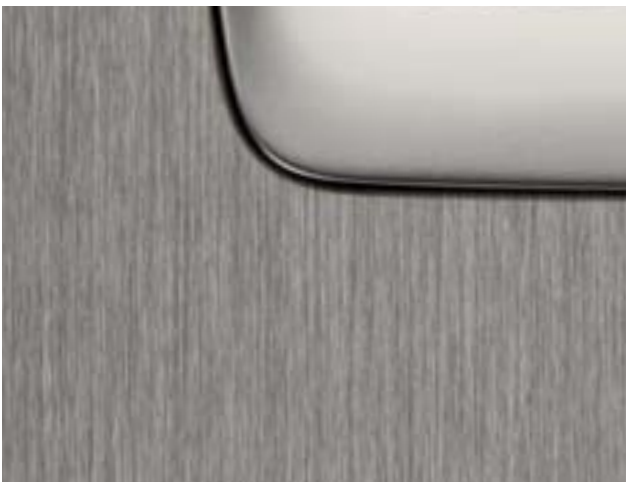

CHOOSE YOUR VOLVO XC60.

As you define your own style and specify your needs, there's a range of equipment levels, factory installed options and accessories that can help reflect your taste or simplify your tasks.

Find your personal Volvo at www.volvocars.us

XC60 TRIM LEVEL:

PREMIER

(3.2, standard on T6, R-DESIGN)

Leather Seating Surfaces
Laminated Panoramic Roof with Power Sunshade
Power Passenger Seat
Tinted Rear Seat and Cargo Area Windows
Silver Accent, Side Décor
Silver Roof Rails
Keyless Drive with Personal Car Communicator (PCC)
Accessory prep cable

PREMIER PLUS

Power Operated Tailgate with Programmable Memory Setting
Active Dual Xenon Headlamps
Park Assist, Front & Rear
HomeLink® Integrated Garage Door Opener
Digital Compass
Cargo Cover
Grocery Bag Holder
12V Power Outlet in Cargo Area
Electric Folding Rear Headrests
Leather Seating Surfaces*
Laminated Panoramic Roof with Power Sunshade*
Power Passenger Seat*
Tinted Rear Seat and Cargo Area Windows*
Silver Accent, Side Décor*
Silver Roof Rails*
Keyless Drive with Personal Car Communicator (PCC)*
Accessory prep cable

* Standard T6 and R-DESIGN

PLATINUM

Navigation System with Voice Control and Map Care
Volvo Premium Sound System
Rear Park Assist Camera
Power Operated Tailgate with Programmable Memory Setting
Active Dual xenon headlamps
Park Assist, Front & Rear
HomeLink® Integrated Garage Door Opener
Digital Compass
Cargo Cover
Grocery Bag Holder
12V Power Outlet in Cargo Area
Electric Folding Rear Headrests
Leather Seating Surfaces*
Laminated Panoramic Roof with Power Sunshade*
Power Passenger Seat*
Tinted Rear Seat and Cargo Area Windows*
Silver Accent, Side Décor*
Silver Roof Rails*
Keyless Drive with Personal Car Communicator (PCC)*
Accessory prep cable

* Standard T6 and R-DESIGN

OPTIONAL PACKAGES:

CLIMATE PACKAGE

Heated front seats
Heated rear seats*
Heated windshield washer nozzles
IAQS (Interior Air Quality System)

* Not available with child booster seats

TECHNOLOGY PACKAGE

Adaptive Cruise Control with Queue Assist
Collision Warning with Full Auto Brake
Pedestrian Detection with Full Auto Brake
Lane Departure Warning
Driver Alert Control
Distance Alert
Active High Beam
Road Sign Information

STANDARD FEATURES

VALUE	R-DESIGN	T6 AWD	3.2
Complimentary Factory Scheduled Maintenance for 5 years, 50,000 miles	●	●	●
SAFETY			
ABS Anti-lock Brakes with EBA	●	●	●
Anti-submarine seats	●	●	
Cargo security cover	●	●	●
City Safety	●	●	●
Daytime running lights (halogen semi-sealed with replaceable bulb)	●	●	●
Driver and front passenger supplemental restraint system – dual-threshold air bags	●	●	●
Dynamic Stability and Traction Control (DSTC)	●	●	●
Electric Parking Brake	●	●	●
Illuminated side marker lights/turn signal indicators	●	●	●
Intelligent Driver Information System (IDIS)	●	●	●
Immobilizer, encrypted ignition key	●	●	●
Inflatable side Curtain (IC)	●	●	●
ISOFIX baby/child seat attachment system	●	●	●
Overhead-mounted seat belt reminder lights	●	●	●
Rear fog light with auto-off	●	●	●
Roll Stability Control (RSC)	●	●	●
Safe approach and home safe lighting	●	●	●
Seat belts: five, 3-point inertia-reel belts with automatic pre-tensioners; front belts have height adjustment	●	●	●
Security system	●	●	●
Side impact air bags for driver and front passenger (SIPS bags IITM)	●	●	●
Side Impact Protection System (SIPS)	●	●	●
Tire Pressure Monitoring System (TPMS)	●	●	●
Top tether child seat anchors	●	●	●
Tunnel Detection	●	●	●
Whiplash protection seating system (WHIPS)	●	●	●
INTERIOR			
Aluminum interior trim	N/A	●	●
Auto-dim rear-view mirror	●	●	●
Bluetooth® handsfree capability	●	●	●
Bluetooth® with streaming audio	●	●	●
Central power door locks with remote control, tailgate and fuel filler door locks	●	●	●

	R-DESIGN	T6 AWD	3.2
Cruise control	●	●	●
Dark-tinted glass (Rear doors and cargo area)	●	●	T
Dual-zone Electronic Climate Control (ECC)	●	●	●
Five padded head restraints	●	●	●
Front and rear 12-volt power outlets	●	●	●
Front center armrest with cup holders and storage	●	●	●
Front door-panel storage pockets	●	●	●
Front seat-back storage pockets	●	●	●
HD Radio	●	●	●
High Performance Audio System with AUX and USB inputs	●	●	●
Illuminated vanity mirrors in driver/front passenger sun visors	●	●	●
Keyless Drive with Personal Car Communicator (PCC)	●	●	T
Leather-clad steering wheel	N/A	●	●
Leather seating surfaces	N/A	●	T
Leather-clad gear lever knob	N/A	●	●
Lockable underfloor storage and cargo area	●	●	●
Luggage/cargo area lights	●	●	●
Pollen filter	●	●	●
Power adjustable driver seat, 8-way with 3-position memory and lumbar support	●	●	●
Power adjustable front passenger seat 8-way with adjustable lumbar	●	●	T
Power windows with driver and passenger auto up/down with anti-trap feature	●	●	●
R-DESIGN aluminum interior trim	●	N/A	N/A
R-DESIGN leather clad gear lever knob	●	N/A	N/A
R-DESIGN leather clad sports steering wheel	●	N/A	N/A
R-DESIGN leather seating surfaces	●	N/A	N/A
R-DESIGN watch-dial blue faced instruments	●	N/A	N/A
Rear seat center armrest with cup holders and storage	●	●	●
Rear seat ventilation outlets on B-pillar	●	●	●
Rear window defroster with automatic timer	●	●	●
Sirius Satellite radio includes 6 month subscription	●	●	●
Tilt/telescopic steering wheel with illuminated cruise and audio controls	●	●	●
T-Tech Fabric Upholstery	N/A	N/A	●
Two-step door opening	●	●	●

INDIVIDUAL OPTIONS

	R-DESIGN	T6 AWD	3.2
Two entry lights (in front door footwells)	●	●	●
Watch-dial instruments	●	●	●
40/20/40 split-folding rear seat	●	●	●
EXTERIOR			
Black Roof Rails	N/A	N/A	●
Bright Roof Rails	●	●	T
Dual exhaust with polished tips	●	●	N/A
Headlight washers	●	●	●
Rain Sensor	●	●	●
R-DESIGN exterior trim	●	N/A	N/A
Power-adjustable heated exterior rearview mirrors with memory function	●	●	●
18" Merac alloy wheels	N/A	N/A	●
18" Zephyrus alloy wheels	N/A	●	N/A
20" Cratus alloy wheels	●	N/A	N/A

EXTERIOR	R-DESIGN	T6 AWD	3.2
Blind Spot Information System (BLIS)	○	○	○
Dual outboard two-stage child booster seats with adaptive seat belts and power child locks (rear doors)	○	○	○
Electronically controlled all wheel drive with instant traction	●	●	○
Metallic paint	○	○	○
Wood Inlay Accent	N/A	○	○
19" Fenrir alloy wheels	N/A	○	○

● = Standard ○ = Option T = Trim Level N/A = Not available



® The Bluetooth word mark and logos are owned by the Bluetooth SIG, Inc. and any use of such marks by Volvo Car Corporation is under license. Other trademarks and trade names are those of their respective owners.









619 Rebel Blue
(only available for R-DESIGN)

498 Caspian Blue Metallic

494 Terra Bronze Metallic



492 Savile Gray
(also available for R-DESIGN)

452 Black Sapphire Metallic
(also available for R-DESIGN)

019 Black Stone

COLOR YOUR VOLVO.

When it comes to the appearance of your Volvo, the choices of exterior color, wheels and other styling items are probably your most important design decisions. For more exterior styling options and to build your new Volvo online, please visit www.volvocars.us

Please note: It's not possible to reproduce exact original shades in printed matter. Please ask your dealer to show you samples.



614 Ice White
(also available for R-DESIGN)



481 Cosmic White Metallic
(only available for R-DESIGN)



477 Electric Silver Metallic
(also available for R-DESIGN)



484 Seashell Metallic



612 Passion Red
(only available for R-DESIGN)



702 Flamenco Red Metallic

THE FIRST RULE OF PERSONALIZATION IS: THERE ARE NO RULES.

Beyond the functional, sensual and practical appointments for your Volvo XC60, consider how to personalize the exterior styling. What will you add to express your style? Something as subtle as lockable wheel bolts, as sporty as 20" wheels or as matter-of-fact as mud flaps? It's up to you.

Add the exterior styling kit shown here and set the stage for a class act. These assertive details accentuate the all-road stance of the Volvo XC60 and include a front bumper bar, the enhanced rear skid plate and side scuff plates. Find your favorite wheels and styling accessories at www.volvocars.us



EXTERIOR DESIGN

EXTERIOR DESIGN Aluminum wheels



Cratus 8x20"
Silver Bright matt
(standard R-DESIGN)



Fenrir 7.5x19"
Black Chrome
(optional T6 AWD and 3.2)



Zephyrus 7.5x18"
Diamond cut/Anthracite matt
(standard T6 AWD)



Merac 7.5x18"
Silver Bright
(standard 3.2)

ACCESSORY Aluminum wheels



Talitha 8x20"
Diamond cut/Dark Grey matt
(accessory)



Talitha 8x20"
Diamond cut/Silver Stone
(accessory)



Achilles 7.5x19"
Diamond cut/Silver Stone matt
(accessory)



Erakir 7.5x19"
Diamond cut/Dark Silver Stone matt
(accessory)

INTERIOR DESIGN



Leather-clad steering wheel, Offblack with Silk metal inlay (standard)



Leather-clad/Classic wood steering wheel, Offblack (optional Wood Inlay Accents)



R-DESIGN Leather-clad sports steering wheel with Silk metal inlay, Offblack (R-DESIGN only)



Leather-clad steering wheel, Soft Beige with Silk metal inlay (standard)



Leather-clad/Classic wood steering wheel, Soft Beige (optional Wood Inlay Accents)



Leather-clad gear knob Offblack, Geartronic



Anthracite Black interior
R-DESIGN leather Offblack/Soft beige, GM60



Brushed aluminum trim



Classic wood trim (optional Wood Inlay Accents)



R-DESIGN trim



Anthracite Black interior
R-DESIGN leather Soft beige/Offblack, GM62



Anthracite Black interior
Leather offblack, G100, optional Wood Inlay Accents



Anthracite Black interior
T-Tec/textile Offblack/Charcoal, G600



Sandstone Beige interior
Leather soft beige, G112, optional Wood Inlay Accents



Sandstone Beige interior
Leather Soft Beige/Espresso Brown, G116,



Sandstone Beige interior
T-Tec/textile Soft Beige, G612

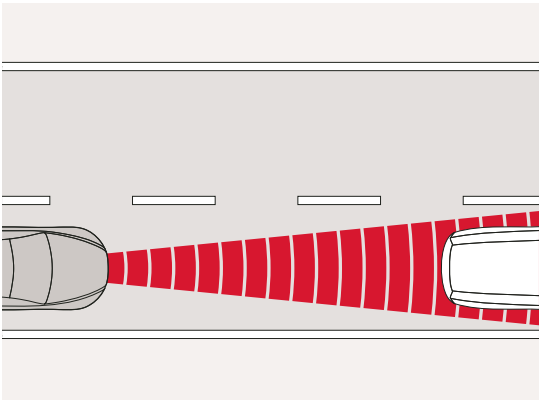

**Adaptive Cruise Control with queue assist
(at all speeds)**

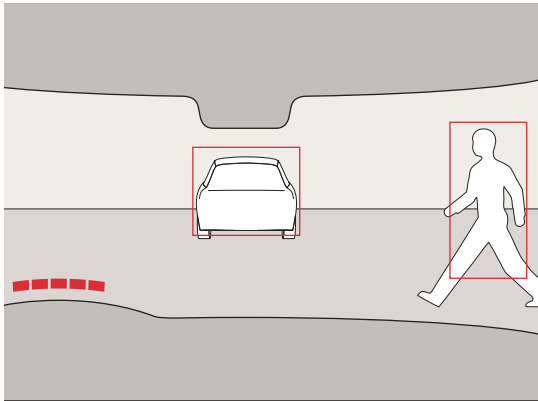

**Collision Warning with Full Auto Brake and
Pedestrian Detection**

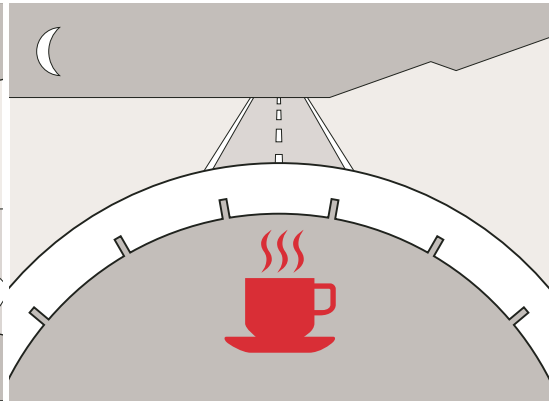

Driver Alert Control (DAC)

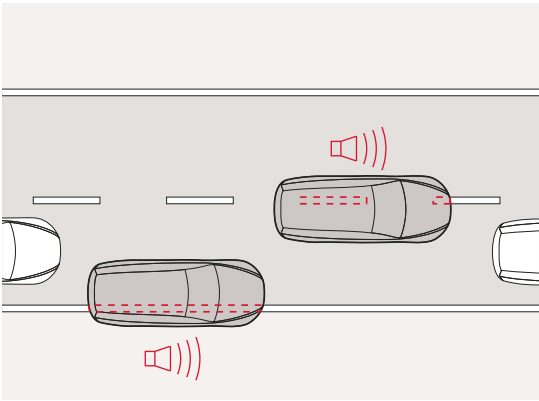

Lane Departure Warning (LDW)

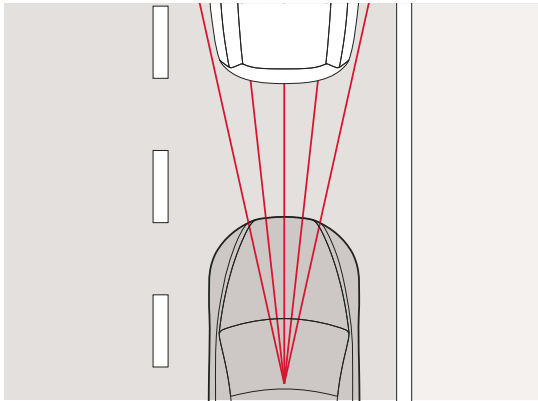

City Safety

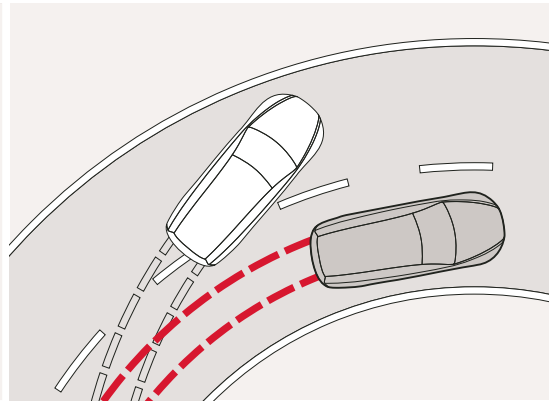

Dynamic Stability and Traction Control (DSTC)

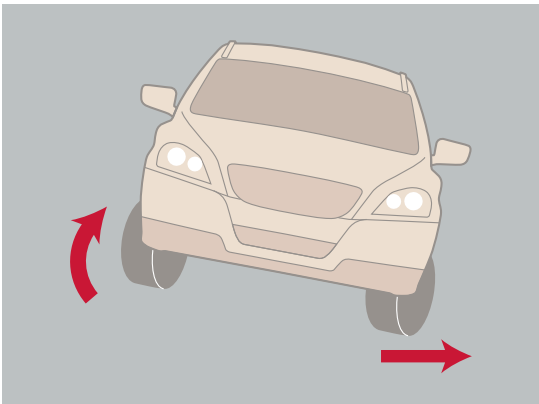

Roll Stability Control (RSC)

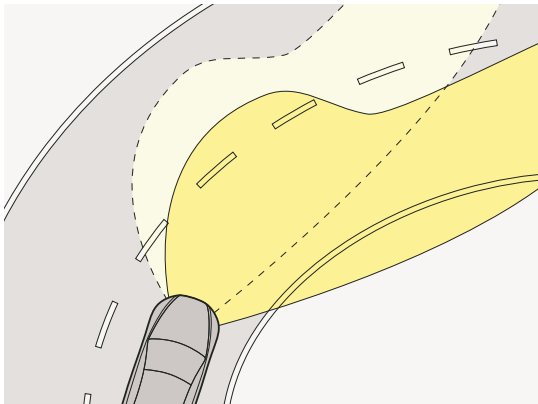

Active Dual Xenon Headlamps



Adaptive brake light

SAFETY

SAFETY Preventive

XC60 Technology Package

Adding to both your safety margins and the driving experience, some of Volvo's most advanced safety driver's support innovations are available in this comprehensive package. Among many things, this includes groundbreaking technology to help avoid collisions, detect pedestrians and alert a distracted driver.

The optional Technology Package contains the following features: Adaptive Cruise Control (ACC) with Queue Assist and Distance Alert, Collision Warning and Pedestrian Detection with Full Auto Brake, Driver Alert Control (DAC), Lane Departure Warning (LDW), Road Sign Information (RSI), Active High Beam (AHB).

Adaptive Cruise Control with queue assist (at all speeds)*

Helping the driver to keep a safe distance from vehicles in front at all speeds up to 124 mph, this third-generation ACC is a supportive partner for a more relaxed driving experience on any journey. In slow-moving city traffic*, the ACC stop and go function automatically adapts your speed to the vehicle in front. From standstill, a press of a button or the accelerator is all it takes to make your car smoothly tail the vehicle in front. At speeds over 19 mph, just select the desired speed and the minimum time gap to the vehicle in front. When the radar sensor detects a slower vehicle in front, the speed automatically adapts to that vehicle. And when the road is clear, the car resumes the selected speed. If ACC is disengaged and a vehicle in front comes too close, the distance alert function activates a warning light in the lower section of the windscreen to help you keep the proper distance.

* Included in the optional Technology Package

Collision Warning with Full Auto Brake and Pedestrian Detection*

Statistics show that in 50% of the rear end collisions the driver at fault doesn't brake at all. Active at all speeds above 2 mph, this third-generation collision avoidance technology can warn you if you're too close to a vehicle in front or if there are pedestrians in your path. If you don't react and a collision is imminent, full auto-braking is engaged to help you avoid or mitigate an impact. Within a range of 492 feet, a radar sensor behind the grille and a digital camera behind the windscreen continuously monitor the distance to the vehicle in front of you. During daylight it can also detect standing or moving pedestrians. If a pedestrian unexpectedly steps out in front of your car or if a vehicle suddenly brakes (or is stationary) and Collision Warning senses that a collision is likely to happen, it will alert you to act with a flashing warning light on the windscreen along with an audible alarm. Moreover, this technology supports driver-initiated braking by pre-charging the brakes to quickly prepare for panic braking and help

reduce the reaction time. If you don't react to the warning and a collision is imminent, the car immediately brakes with full braking force.

* Included in the optional Technology Package

Driver Alert Control (DAC)*

Up to 90% of all traffic accidents are caused by driver distraction. Driver Alert Control is a unique technology that can help alert a tired or distracted driver at speeds over 40 mph. Using signals from a digital camera to monitor the road ahead along with data from steering wheel movements, DAC can compare erratic behaviour to your normal driving style. If DAC detects that you begin to drift within your lane, you receive an audible warning. At the same time, a message is displayed in the instrument panel suggesting it might be time for a break.

* Included in the optional Technology Package

Lane Departure Warning (LDW)*

At speeds over 40 mph, Lane Departure Warning can help prevent single-vehicle road departures as well as collisions caused by temporary distraction. This function uses the digital camera to register the lane markings and help monitor the car's position on the road. If you weave out of your lane, LDW will alert with an audible signal. If you intentionally cross a lane marker using the direction indicators, LDW is not activated.

* Included in the optional Technology Package

Road Sign Information (RSI)*

With RSI you don't have to miss important road signs. A forward camera detects speed limits. The actual sign is then displayed in the driver information module to help keep you constantly updated on current limitations. If you want, RSI can also alert with a visual warning if you exceed the speed limit.

* Included in the optional Technology Package

Active High Beam (AHB)*

Active High Beam enhances both convenience and safety when you drive in the dark. Employing camera technology, AHB recognizes the headlight beam of on-coming vehicles and automatically shifts between low and high beam to optimise your vision without dazzling other drivers.

* Included in the optional Technology Package

City Safety

City Safety collision avoidance technology is a Volvo world-first standard feature for safer urban driving. At speeds up to 31 mph, this laser-based technology can sense if a vehicle in front within 20-25 feet is at a standstill or is moving slower. If City Safety senses an impending collision, the brakes are pre-charged to act faster on your response. And if you don't brake, City Safety automatically applies the brakes and switches

off the throttle to help you avoid or mitigate a collision. City Safety is activated when you start the car, but can be switched off if you, for instance, are driving in deep snow.

Dynamic Stability and Traction Control (DSTC)

By helping prevent fishtails, spinouts, and rollovers, stability control technology like DSTC has been described as one of the most vital safety advances of the past decade. At the core of DSTC, sensors registers the car's direction and roll rate. The system compares this with steering wheel movements as well as the actual rotation of the car's wheels. DSTC is able to detect a potential skid and help counteract this by reducing the engine's power output, or braking on one or more wheels. Further developed in the XC60, this technology also adds to stability in dynamic driving where the vehicle is exposed to high lateral forces.

Intelligent Driver Information System (IDIS)

To help avoid distractions during critical driving situations, IDIS constantly analyzes your driving and will delay secondary information from the car or one of its onboard systems when it detects intense steering, braking or acceleration. As soon as things calm down the delayed information is presented.

Roll Stability Control (RSC)

In the event of an emergency maneuver, Volvo's Roll Stability Control (RSC) can step in to help prevent the vehicle from rolling over. It features a gyroscopic sensor that registers the vehicle's lean angle and rollover risk. If required, RSC will cut engine power or brake one or more of the wheels just enough to reduce the centrifugal force and help regain balance.

Active Dual Xenon Headlamps*

Compared to conventional halogen headlamps, Active Bending headlights with Dual Xenon technology expand your vision range by about 230%. This means you'll be helped to gain 150 feet more for braking. And using motorised lamps that turn up to 15° in either direction, this technology gives a 90% boost to your vision round bends at night. You can enjoy highly effective low beam illumination on narrow, winding roads and extremely powerful full beams on the motorway. A daylight sensor disengages the adaptive function during daytime to extend its lifespan. Independent of the load, these headlights self-adjust to maintain the correct angle to the road – even during hard acceleration or braking.

* Standard R-DESIGN, included in Premier Plus and Platinum trim levels

Adaptive brake light

Active at speeds above 30 mph, the adaptive brake light can sense the difference between normal and panic braking. If it is a panic situation, all the brake lights will flash at a rate of four times per second. Once your speed slows to below 19 mph, the lights stop flashing and hazard lights flash instead.



Volvo's interactive safety technologies



Restraint technologies



Inflatable Curtain (IC)



Whiplash Protection System (WHIPS)

SAFETY

SAFETY Protective

Volvo's interactive safety technologies

In a Volvo, safety is about interaction. Because it's not the number of safety features that determines how safe a car is, it's how well they seamlessly interact to help protect the occupants in the event of a collision.

IN A REAR IMPACT the rear deformation zones will help absorb crash energy. The fuel tank is designed to remain well protected in front of the rear axle. The head restraints help protect the neck and spine, and Volvo's unique Whiplash Protection System (WHIPS) cradles the front seat occupants in a controlled manner to help prevent whiplash injuries.

IN A SIDE IMPACT Volvo's unique Side Impact Protection System (SIPS) helps distribute the crash forces across the car's body, away from the occupants. The side airbags in the front seats help protect the chest and hip, while the Inflatable Curtain (IC) adds head protection.

IN A ROLLOVER a gyroscope activates Volvo's Roll-Over Protection System (ROPS). The safety belt pre-tensioners deploy to help keep occupants more securely restrained, and the Inflatable Curtain (IC) helps provide head protection. Additionally, the safety cage is reinforced to help keep the passenger compartment intact.

IN A FRONTAL COLLISION the patented frontal structure will yield to help absorb and disperse crash energy. The compact power train is designed to help optimize deformation. Inside the car, safety belts interact with the collapsible steering column and dual-stage airbags to help keep the occupants out of harm's way. Pre-prepared restraints – a unique Volvo technology – helps optimize the various restraint systems for expected crash force. A lower cross member helps protect occupants in an oncoming car with lower positioned bumpers.

Restraint technologies

In a collision, Volvo's restraint technologies interact to help reduce the impact. The **safety belts with pre-tensioners** activate within a few thousandths of a second in the event of a collision or roll-over and tighten the belt to help keep the occupants securely restrained. The front seat safety belts then release a little so that the driver and passenger are cushioned by the airbags in a controlled manner. Helping to optimize protection, the **dual-stage airbags** adapt the level of inflation depending on the force of the collision. The driver's airbag also interacts with the deformation of the collapsible steering column.

Side airbags in the front seats help reduce the risk of serious injuries in a side collision. In a collision or roll-over, the **Inflatable Curtain (IC)** helps protect the heads of both front and rear outboard occupants. It also stays inflated for some seconds to provide prolonged protection in multiple accidents. And to help protect children in the rear seat, IC interacts with the two-stage integrated booster cushions and the belt load limiters.

Whiplash Protection System (WHIPS)

Integrated in the front seats, Volvo's WHIPS cradles the occupant to help reduce the risk of whiplash injury (one of the most common types of traffic injury and often the result of a low-speed rear impact collision). The function is activated by a collision of sufficient force from behind. Independent research has shown that WHIPS is one of the most effective systems in the world and can reduce the risk of long-term invalidity by 50%.

Energy-absorbing frontal structure

In developing this Volvo's protective qualities, we have focused on frontal collisions at both higher speeds and with heavier vehicles. The patented frontal structure with its sizeable deformation zones in different kinds of steel will yield to help absorb crash energy. The compact power train is designed to help optimize deformation. The unique geometry of the frontal structure and longitudinal steel struts in the doors help disperse crash energy away from the front to the rear of the car, further helping to reduce the strain on the occupants. A steel cross-member under the dashboard further helps keep the cabin intact.

Side Impact Protection System (SIPS)

SIPS is a Volvo unique safety system that has been developed to help protect where occupants are most exposed to the crash forces. The steel framework of the car – including the front seats – is designed and reinforced to help displace the impact of a side-collision away from the occupants to other parts of the car body and help prevent intrusion into the cabin. The extremely strong side structure contains ultra-high strength steel to help withstand a severe side impact – even with a larger vehicle. The Inflatable Curtain (IC) for all the outboard occupants and the front seat side airbags interact with the SIPS to help provide further protection. In the rear seat, the combination of extended IC and Volvo's integrated two-stage booster cushion with progressive safety belt load limiters helps protect children who have grown out of their rearward facing child seat.



Keyless Drive with Personal Car Communicator (PCC)



HomeLink®



Power retractable door mirrors with ground lighting



Power front seats



Laminated Panoramic Roof

SAFETY

SAFETY Security

Keyless Drive with Personal Car Communicator (PCC)*

PCC is an advanced remote control that combines keyless drive with two-way communication with your Volvo. Keep the key fob with you and the car unlocks automatically as you pull the door handle. Start the engine by pressing a button on the dash, lock the car by pressing a button in the door handle. Later in the day, if you're wondering whether you've locked the car, PCC can remind you; no matter where you are. On your return to the car – within a radius of 200 to 300 feet – pressing the PCC information button will give you a current report on its status. If the alarm has been activated.

* Included in the Premier, Premier Plus and Platinum trim level. Standard on T6 and R-DESIGN.

HomeLink**

With buttons integrated in the sun visor, HomeLink® allows you to operate remote controlled home appliances – such as garage door, home alarm and exterior lighting – without leaving the car.

HomeLink is a registered trademark of Johnson Controls Technology Company.

* Included in the Premier Plus and Platinum trim level

Power retractable door mirrors with ground lighting*

At the touch of a button, these door mirrors can be folded flat against the car where they are less likely to get damaged after you've parked. They can also be set to fold or unfold automatically everytime you lock or unlock the car. The integrated ground lighting is activated with the remote control or with the PCC. Beyond enhancing security to and from your car at night, this is also convenient when getting in and out. And to facilitate parking, the door mirror on the passenger side can tilt automatically when reversing.

* Only available with Blind Spot Information System (BLIS)

Approach and Home Safe Lighting

Activated with the remote control or Personal Car Communicator, Approach Lighting provides a warm reception on a dark night. This consists of interior and side lights – ground lighting too, if you choose it. Home Safe Lighting is activated with the headlight stalk as you leave the car and it provides a similar courtesy when exiting your car. This feature includes a dipped beam from the headlight to accompany you to your door.

COMFORT

COMFORT Seats

Power front seats

Find your perfect driving position with push-button ease. The driver's seat also incorporates a memory function that stores three separate seat and door mirror settings connected to a specific remote control – a feature that's appreciated when the car has several drivers. Dual power seats are available in the Premier, Premier Plus and Platinum trim levels. Standard on T6 and R-DESIGN.

Heated seats, front and rear*

Adjustable in three settings, heated seats for the driver and front seat passenger add to comfort on those cold mornings. And to enhance comfort for friends in the rear seat, this convenience is also available for the outer rear seat positions.

* Included in the optional Climate Package

COMFORT Climate

Laminated Panoramic Roof*

This exclusive Laminated Panoramic roof will further enhance the experience of air and light for everyone inside the Volvo XC60. The front section can be opened at the push of a button, either by sliding it over the rear part, or by tilting it in the rear end. To help maintain climate comfort on sunny days, there's a power operated roller curtain. Dark tinted laminated glass increases comfort and security. It also helps protect from UV radiation. For safety reasons, the design of the panoramic roof is optimized and the two-piece glass is laminated.

* Included in the Premier, Premier Pplus and Platinum trim level. Standard on T6 and R-DESIGN

Electronic Climate Control (ECC)

Electronic Climate Control (ECC) maintains the cabin temperature you choose and can be set independently for the driver and front passenger. Further contributing to your health and comfort, Volvo's unique humidity sensor helps ensure cabin air has an appropriate level of humidity according to the outside climate.

Interior Air Quality System (IAQS)*

Volvo's IAQS continuously monitors incoming air and will, if necessary, temporarily close external air vents to shut out carbon monoxide, ground-level ozone and nitrogen dioxide. Meanwhile, an active carbon filter protects the occupants from other harmful gases and unpleasant odours. This helps to ensure that the air you breathe in the car is cleaner than that outside when driving in heavy city traffic and tunnels.

* Included in the optional Climate Package



Sun glass holder



Volvo Sensus

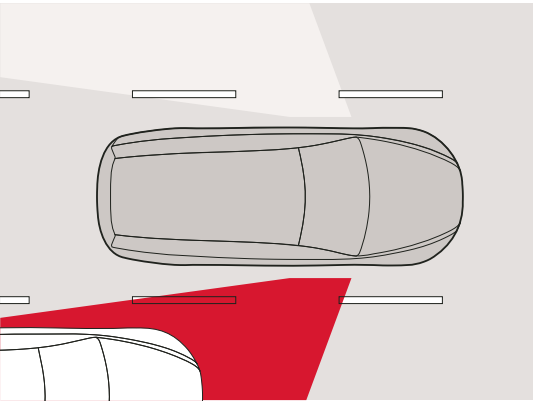

Blind Spot Information System (BLIS)

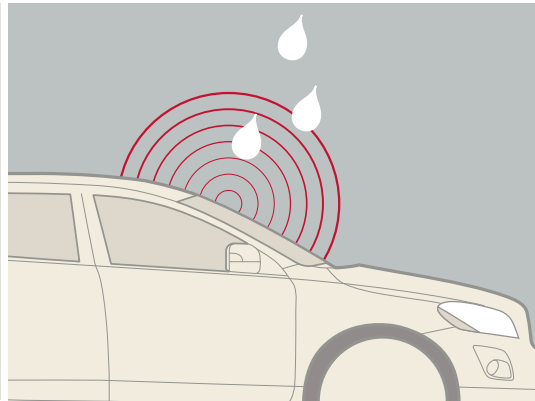

Rain sensor

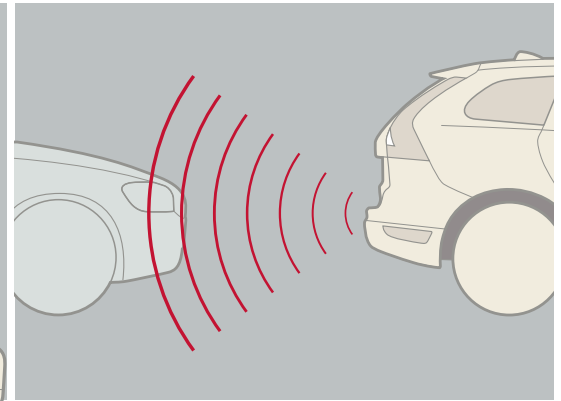

Front and Rear Park assist



Park Assist Camera



Integrated Bluetooth® handsfree system



Volvo Navigation System (VNS) with RTT (Real Time Traffic)

COMFORT

COMFORT Storage

Front center armrest, multifunctional

The central aisle of the cabin incorporates several facilities. Two cup holders are concealed by a roll-top cover. There's a handy storage space beneath the armrest, and special recesses for small items. Folding back the upper part of the armrest will provide a convenient table for the rear seat passengers. The armrest also features an AUX input and a USB port to connect your MP3 player to the car's audio system.

Sun glass holder*

Fitted in place of any of the entry grab-handles in the front, this holder keeps your glasses or sun glasses within reach. Simply press the oil-damped cover and it opens up.

* Retailer installed accessory

TECH & SOUND

TECH & SOUND Driver's Support

Volvo Sensus

Volvo's driver control interface allows you to conveniently explore the hi-tech features of your car and personalise them to suit your needs. All information is displayed on a high resolution 7" color screen. A push of the MY CAR button in the center console gives you access to all system settings such as City Safety, ACC, Collision Warning with Full Auto Brake and Pedestrian Detection, Driver Alert System, BLIS, light, door mirrors, climate, central locking and audio.

The standard 7" screen can also display the audio system, RTI navigation system, phone, and park assist camera

Everything is conveniently controlled using the ergonomic steering wheel controls – so you can keep your attention on the traffic and your hands on the steering wheel.

Blind Spot Information System (BLIS)*

BLIS uses rear-facing cameras installed in the door mirrors to keep a lookout on either side of the car. As a vehicle enters your blind spot, this function can alert you with a lamp built in to the front door post – left or right. Together with the door mirrors, BLIS helps you assess the feasibility of a lane change. BLIS is activated once the car exceeds 6 mph, and reacts to almost any type of vehicle from a motorcycle upwards, day or night.

* Optional

Rain sensor with tunnel detection

Once activated, the standard rain sensor can start the windscreen wipers as soon as it begins to rain or if water splashes onto the windscreen. For your convenience, it can also automatically adapt the intermittent windscreen-wiper function. Its sensitivity can be adjusted via a ring on the wiper stalk. and as you enter a tunnel in daylight, the optional Tunnel Detection sensor will activate your car's headlamps and turn them off when exiting the tunnel.

Front and Rear Park assist*

Activated when you engage reverse gear, rear park assist helps you when reversing into tight spaces. The audio system is turned down and a pulsating sound from the rear loudspeakers becomes a continuous tone as you approach an obstacle. Front park assist performs a similar function at the front of the vehicle – alerting you via the front loudspeakers. The remaining distance is also shown on the audio display.

* Included in the Premier Plus and Platinum trim level
Also available as an accessory

Park Assist Camera*

If the car is equipped with Volvo Navigation and park assist, the camera helps display what's going on behind your car when backing up. The system uses the navigation screen and a camera discretely located over the license plate. On-screen guiding lines provide extra assistance for smooth parking.

* Included in the Platinum trim level. Also available as an accessory.

TECH & SOUND Communication

Integrated Bluetooth® handsfree system with streaming audio

Bluetooth® technology enables a mobile phone to be connected to the infotainment system in your Volvo, wirelessly. Once configured for a mobile phone, the system automatically recognizes your phone as you enter the car. And as you climb in and out of the car, the system automatically allows you to switch freely from the phone to the handsfree system and back again.



® The Bluetooth word mark and logos are owned by the Bluetooth SIG, Inc. and any use of such marks by Volvo Car Corporation is under license. Other trademarks and trade names are those of their respective owners.

Volvo Navigation System (VNS) with RTT (Real Time Traffic)*

Volvo's GPS-based VNS navigation system is totally integrated with your car. It offers both voice guidance and graphic navigation all the way to your destination. Via TMC (Traffic Message Channel) radio data broadcasts VNS also lets you know if there's weather-related trouble on route and recommends an alternative. The VNS system is easily controlled from the steering wheel or a remote, and the screen is positioned so you can keep your attention on traffic.

* Maps do not cover all areas or all routes within an area. Also constant expansion and rebuilding of the road network mean that the digital map database is not always the latest road information. Always follow relevant regulations and road information.

* Included in the Platinum trim level. Also available as an accessory.
Requires the accessory prep cable (000445)



Rear Seat Entertainment (RSE) with dual DVD players



Three-split 40/20/40 rear seat

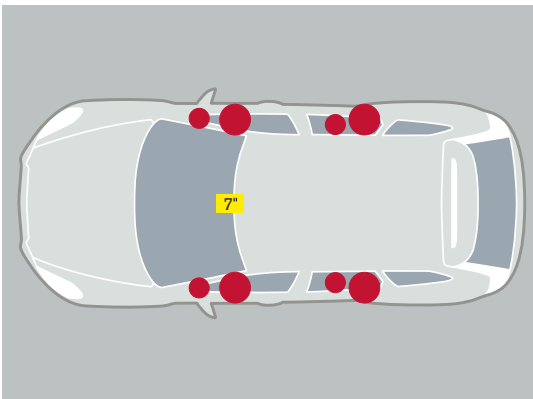

High Performance Multi Media system

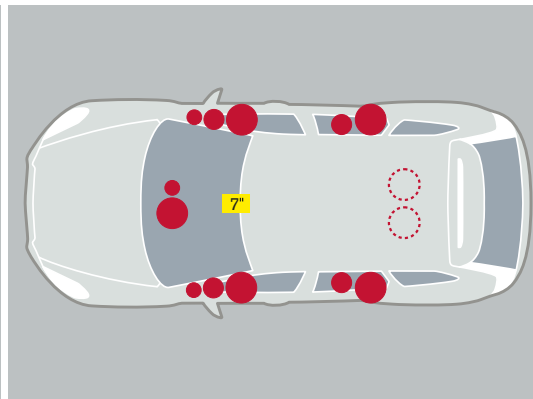

Premium Sound Multi Media system



Foldable front seat backrest



SiriusXM Satellite Radio



Grocery bag holder



Load compartment mat, reversible and foldable

TECH & SOUND

TECH & SOUND Audio/Entertainment

MP3/iPod® compatibility

There are a number of ways to enjoy MP3 music files in your Volvo. If you'd like to connect your personal MP3 player to the audio system, there's a standard auxiliary audio input in the front center armrest. Volume is conveniently controlled from the steering wheel, center console or rear seat audio console. There's also a USB port that allows you to fully integrate your iPod®, MP3 player or USB device with the audio system or utilize Bluetooth® with streaming audio capabilities. Playlists, songs and artists are clearly displayed in the center console, while your player will be charged at the same time. The audio systems also feature a MP3 and WMA compatible CD player.

iPod is a trademark of Apple Computer Inc.

Rear Seat Entertainment (RSE) with dual DVD players*

For more fun on long journeys, this easy-to-use system will entertain for hours. There are dual DVD players and dual 7-inch screens smartly integrated in the front head restraints. Each DVD player is conveniently operated by a rear seat passenger, and the screens can be adjusted in different angles to optimize image quality. The AUX sockets are within easy reach and make it possible to view a film on one screen and play games on the other. Sound is provided via the car's audio system or wireless headphones.

* Retailer installed accessory

High Performance Sound system

This is a powerful and versatile 160 W audio system featuring advanced technology such as Bluetooth® and USB/iPod® connectivity. Each of the 8 loudspeakers is fitted with a powerful

magnet and a large coil. In combination with the amplifier, this system gives excellent transient reproduction and high power – simply superb sound.

Premium Sound system*

We designed this top-of-the line audio and infotainment system to give you a superior listening and communication experience. This 650 W system features twelve high-fidelity loudspeakers that optimize the sound reproduction for the interior acoustics. Dolby® Pro Logic® II surround sound helps tailor a well-balanced audio experience for each occupant. And to give you access to advanced in-car entertainment, communication and navigation technology, this system also connects with most media formats and players.

Dolby, Pro Logic, and the double-D symbol are registered trademarks of Dolby Laboratories.

* Included in the Platinum trim level

SiriusXM Satellite Radio

Imagine driving along hearing the music you want, without having to flip through commercials, fumble with CDs or manage a playlist. Imagine hearing play-by-play action of your favorite team, no matter where you are. Or having channels and channels of comedy, talk, news, entertainment, family programming and more. Now Imagine having all of this, coast-to-coast, wherever you drive. This is the world of SiriusXM. Each Volvo equipped with Satellite radio includes a 6-month trial subscription to the "Sirius Select" package.



PACK & LOAD

PACK & LOAD Compartment

Three-split 40/20/40 rear seat

Ergonomically designed three-split rear seat provide generous support for the body during long journeys and flexibility when required. Lowering the entire center section provides ample space for loading long items. To provide multiple load configurations with a flat load floor, each of the three seats can be folded separately or together. What's more, the rear seats only take one step to maneuver.

Foldable front seat backrest

To help you carry long objects inside your Volvo, the front passenger seat backrest can be conveniently folded flat.

Power tailgate*

The tailgate can be opened automatically three ways: with the remote control, using the switch on the dashboard, or by pulling the handle. To help minimize risk of injury, only a switch in the tailgate can be used to trigger automatic closing. Also, an anti-pinch strip around the tailgate opening can detect obstructions to help avoid pinching fingers.

* Included in the Premier Plus and Platinum trim level

Grocery bag holder*

This integrated holder unfolds from the load compartment floor and keeps your shopping bags and other similar items in place.

* Included in the Premier Plus and Platinum trim level

Load compartment mat, reversible and foldable*

Allows you to maintain the elegant appearance of the load compartment even if you occasionally transport dirty loads. With folded rear seat backrests, just fold out the mat to cover the entire load compartment floor. The mat is reversible and waterproof, with color-keyed textile on one side and plastic on the other.

* Retailer installed accessory



Roof load carrying system



Square profile trailer hitch

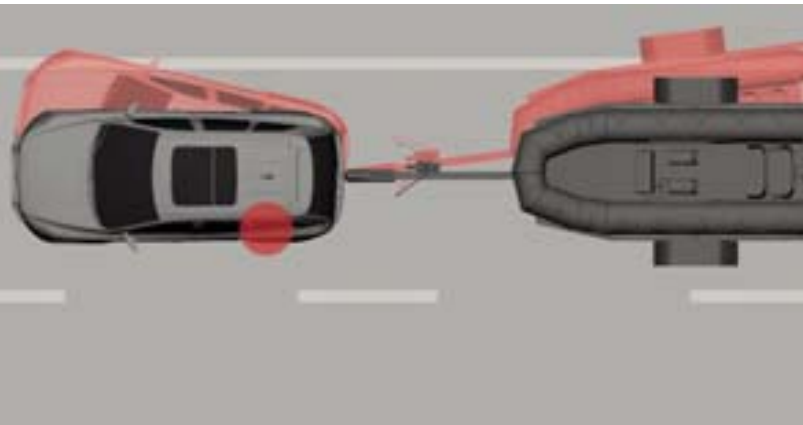

Trailer Stability Assist (TSA)

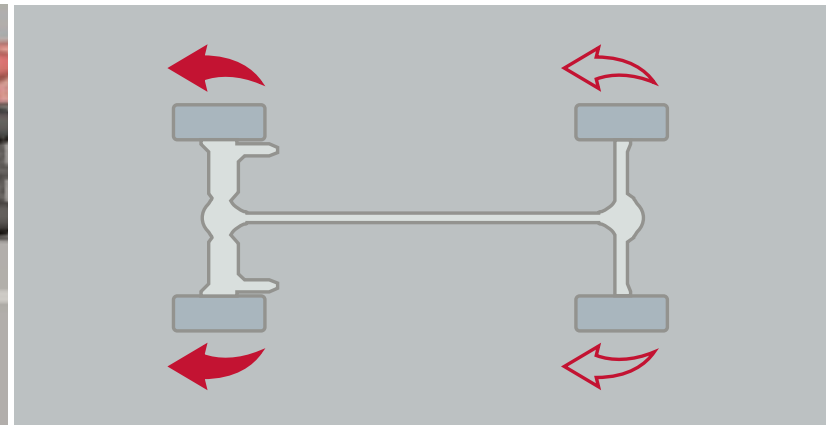

All-wheel drive with Instant Traction™

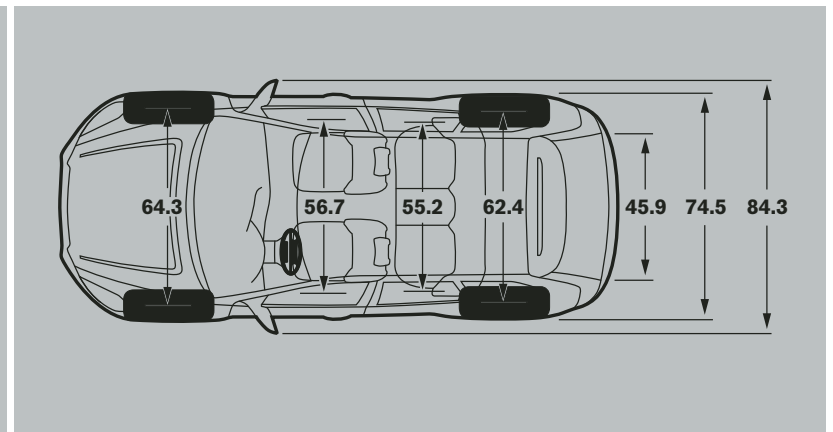
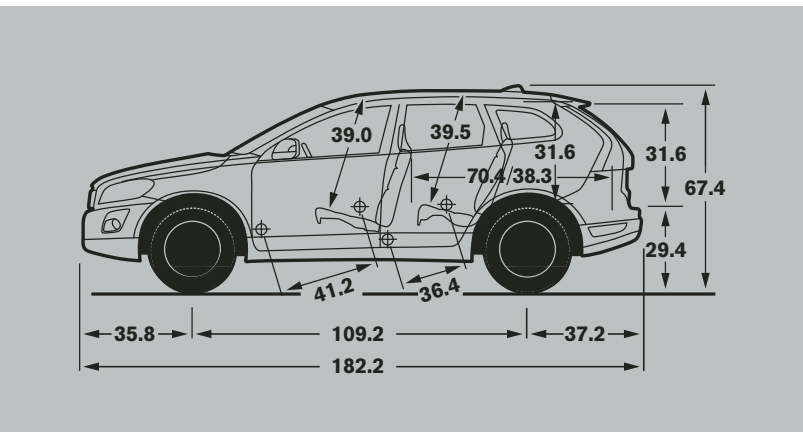

PACK & LOAD

PACK & LOAD Carrying/Towing

Roof load carrying system*

To help you fully utilize the roof of your Volvo, we've developed a range of versatile load carrying accessories. This system is dimensioned to carry up to 220 pounds. The roof rails make the load carriers easy to fit. Various load accessories – such as roof boxes and different holders for bikes, skis, surfboards and kayaks – can be attached to the load carriers to meet your needs. These accessories can be freely combined for flexibility and many are aerodynamically designed to help reduce fuel consumption and wind noise. And most of them can be locked with the same key, using Volvo's One-Key System.

Square profile trailer hitch*

This robust detachable hitch is not only great for towing but can also be used to transport bikes and skis.

* Retailer installed accessory

Trailer Stability Assist (TSA)

When towing a trailer or caravan, the Trailer Stability Assist can counteract so called snaking to help maintain stability. TSA continuously monitors oscillation tendencies and can help prevent these by braking one or more wheels to compensate. If this is not sufficient, or the driver ignores it, the braking will be on all four wheels and the engine torque will be reduced. TSA is active at speeds from 30 mph.

PERFORMANCE

PERFORMANCE Chassis/Steering

Chassis

The chassis is optimized for sporty and well-balanced handling with a high level of comfort. For the driver, an advanced multi-link rear and McPherson spring strut front suspension mounted on a rigid body with a low center of gravity translates into a feeling of being in command and in safe control. Generous ground clearance and short overhangs contribute to driveability on rough roads and even off-road. conditions change, wheels with the best grip get the most power. When a tire loses traction, power is reduced to that wheel and instantly transferred to the more sure-footed wheels.

PERFORMANCE Transmission

Six-speed Geartronic automatic transmission

For the best of two worlds, there's the six-speed Geartronic – a responsive automatic that's ideal for relaxed driving, tough conditions or towing. This also allows manual gear shifting so you can maintain a lower gear to bring up the revs or for the added assistance of engine braking. A special winter setting makes it easier to move off and maintain grip on slippery surfaces. on the T6 and R-DESIGN models, this automatic also features a sports mode for more active driving.

All wheel drive with Instant Traction™ *

The advanced Haldex AWD technology with Instant Traction™ helps increase driving stability and traction on all road surfaces. It has an electronic management system that constantly monitors the speed of the wheels, the throttle, engine torque, engine speed and the brakes. As driving conditions change, wheels with the best grip get the most power. When a tyre loses traction, power is reduced to that wheel and instantly transferred to the more sure-footed wheels.

* Standard on T6 and R-DESIGN

PERFORMANCE Engines

Six-cylinder, in-line, all-aluminum engines.

Double overhead cam-shafts, 24 valves with Variable Valve Timing (VCT). These engines also feature Variable Intake System (VIS) and Cam Profile Shifting (CPS) on the intake camshaft. Electronic engine management system. Three-way catalytic converter with heated oxygen sensor.

These highly compact, in-line, six-cylinder engines meet high expectations in terms of performance, comfort and environmental care. Their smooth running and responsive character provides a relaxed yet responsive drive at all speeds. Advanced engine technology, such as a new intake system, helps increase torque over a wide speed range and ensures power at high rpm. On the T6, twin-scroll turbocharger technology provides extremely quick turbo boost. And depending on your driving style and the situation, the intake valve train automatically switches between economy and performance modes to optimize efficiency. The engines' compact design aids safety performance in a frontal collision. The latest generation of fast response emission control technology ensures that the engines comply with stringent environmental standards such as California's ULEV II.

XC60 T6 AWD

XC60 T6 AWD R-DESIGN

Engine type: 3.0 liter in-line six-cylinder engine with Twin-scroll turbo
Max power output: 300 hp at 5600 rpm,
325 hp at 5400 R-DESIGN
Max torque: 325 lb/ft at 1500 rpm,
354 lb/ft at 3000 rpm R-DESIGN
Acceleration: 0–60 mph 6.9 sec (T6)
Top speed: 130 mph
Fuel consumption: N/A
Environmental classification: ULEV II
Transmission: Six-speed Geartronic Automatic
Fuel tank: 18.5 US Gallons (70 liters)

XC60 3.2

Engine type: 3.2-liter in-line six-cylinder engine
Max power output: 240 hp at 6200 rpm
Max torque: 236 lb/ft at 3200 rpm
Acceleration: 0–60 mph 8.6 sec
Top speed: 130 mph
Fuel consumption, MPG, mixed cycle: N/A
Environmental classification: ULEV II
Transmission: Six-speed Geartronic automatic
Fuel tank: 18.5 US Gallons (70 liters)

TAKING CARE OF YOUR OWNERSHIP NEEDS.

VOLVO LEASING AND FINANCING OFFERS.

Special offers are available to finance or lease your new Volvo product. Whether you are looking for the convenience of a lease or the pride of owning your Volvo vehicle, our nationwide network of retailers and authorized financial service providers are ready to assist you with all your financing needs. please contact your local retailer for details.

On Call roadside assistance.

Whenever you need us, we're just a phone call away. Our nationwide network of retailers and authorized service providers are ready to assist. Whether you require roadside assistance or maps and routing information for your next trip, refer to your On Call Card and dial 1-800-63-VOLVO – anytime, day or night. Your complimentary four-year membership activates the moment you become a Volvo owner.

Volvo new car warranty.

Your new car warranty provides comprehensive coverage for five years or 50,000 miles, whichever occurs first. Additional warranties cover corrosion, seat belts, the supplemental restraint system, emission systems, genuine Volvo replacement parts and genuine Volvo accessories. Should you encounter any problem with your Volvo, simply contact the nearest retailer for assistance. Where your warranty ends, Volvo Increased Protection (VIP) plans begin. To purchase the additional protection of a VIP plan, contact your local retailer.

Complimentary Factory Scheduled Maintenance.

Volvo is committed to a premium ownership experience for its customers. To further enhance your ownership experience, all 2013 model year Volvo's sold in the united states will include Complimentary Factory scheduled maintenance. This program provides scheduled maintenance coverage for the first 5 years or 50,000 miles, is designed to compliment your Volvo warranty, and will help ensure trouble free operation of your Volvo. Coverage includes factory recommended maintenance including oil and filter changes, checks and adjustments as listed in your warranty and maintenance records Information booklet, for the first five maintenance services at intervals of 10,000, 20,000, 30,000, 40,000 and 50,000 miles.

Service must be performed within 1,500 miles before or after each scheduled interval. Coverage is limited to scheduled maintenance items listed in the 2013 model year Warranty and Maintenance Records Information booklet. An authorized retailer must perform maintenance. Offer is transferable. Optional Factory Scheduled Maintenance program upgrades are also available that will allow you to customize coverage to meet your driving needs. See your Volvo retailer for details.

Volvo service for life.

Taking the concept of service to a new level.

- Two-year Parts Warranty. Including the labor when they're installed at an authorized Volvo retailer

- Complimentary Software Updates during a scheduled maintenance visit. New software required as part of repair or accessory installation is not included
- Complimentary Vehicle Diagnostics if your Volvo has a "check engine" lamp or other warning indicator illuminated. Up to an hour of computer diagnostics
- Special discounted On Call Advantage Roadside Assistance pricing. Visit your retailer for enrollment form

Volvo mobility program.

The goal of the Volvo Mobility Program is to assist persons with physical disabilities or hearing impairment. For those with exceptional transportation needs, this can be facilitated within the extraordinary comfort and safety of a specially adapted Volvo. For additional information on this program, please contact the Volvo Mobility Program Headquarters at (800) 803-5222 or visit www.volvocars.us/mobility. TTY users are invited to call 1-800-833-0312.

Personal shopper.

The Volvo Personal Shopper is dedicated to providing you with a whole new level of shopping convenience. Whether you'd like help identifying the Volvo model that best fits your lifestyle, detailed information on any Volvo model, or a comparison against the competition, Volvo is there to help. We can arrange a Guest Drive for you at your nearest Volvo Retailer. So make the most of your shopping time and call the Volvo Personal Shopper at 1-800-550-5658. (U.S. only)

VOLVO OVERSEAS DELIVERY.

Volvo Overseas Delivery offers a unique way to buy your new custom-built car as well as a unique way to see more of Europe. And when you're done traveling, bring the pleasure of driving a Volvo back home. Purchase any new Volvo as part of the Volvo Overseas Delivery Program and enjoy all this – and more:

- Attractive pricing on US models.
- Access to colors and certain features normally only available in Europe.
- 15 days of international insurance and export registration included.
- Two complimentary round-trip tickets with Scandinavian Airlines (peak season surcharge may apply).
- One free hotel night in Gothenburg, Sweden, the home of Volvo.
- An exciting Volvo Factory Tour or a visit to the new Volvo Brand Experience Center.
- An exclusive VIP delivery experience at the Volvo Factory Delivery Center.
- The opportunity to explore Europe in the comfort and safety of your own Volvo, either with one of our spectacular tours or on your own.
- Extensive complimentary home shipment services. Just leave your car with us. We'll ship it to you the convenient way while you relax and enjoy your complimentary flight back home.

Can you think of a better way of traveling overseas and making your souvenir part of an unforgettable experience? If you would like to know more, contact your local Volvo retailer, our Customer Care Center (800) 631-1667, or visit www.volvocars.us/mybagsarepacked www.facebook.com/volvooverseasdelivery

VOLVO CARS MILITARY/DIPLOMAT/ EXPATRIATE SALES. FOR YOU LIVING ABROAD.

Sometimes life abroad offers exceptional benefits. Such as buying a new tailor-made Volvo on very special and rewarding terms. Whether you are traveling for pleasure or are in a professional, diplomatic or military post outside your home country, turn to Volvo for a great deal. For US Military personnel posted overseas our authorized military agents outside the US offer:

- Great savings compared with Stateside pricing.
- Professional assistance with all legal formalities and paperwork.
- Four-year warranty coverage also outside the US (US and Canadian specifications)
- US specifications – built to meet legal requirements in all US states.
- No US import duty with PCS orders, for US military personnel taking delivery overseas.
- Included shipping & Marine Insurance, delivery to an authorized Volvo retailer of your choice in the USA. US diplomats & military personnel stationed abroad for more than 140 days & non-US diplomats (depending on status) are normally exempted from customs import duty.
- Delivery to a Volvo military agent close to your base or assignment overseas.
- Five years valid Volvo Home Shipment from authorized drop-off points in Europe to an authorized US Volvo retailer of your choice included.
- More than 20 drop-off points in Europe.
- The option of VIP factory delivery in Sweden or delivery to selected major cities in Europe.
- The option of our special Cruise & Collect package with Stena Line ferries (German market).
- The benefit of the Volvo Assistance Europe scheme at no extra cost.

Taking advantage of the savings, benefits and convenience of Volvo's international programs is easy. Volvo Cars Military Sales, Volvo Cars Diplomat Sales and Volvo Cars Expatriate Sales are professional and global organizations with one goal – to make it advantageous and convenient for you to buy your new car when living abroad. www.military.volvocars.com www.diplomat.volvocars.com

While in the us, Military personnel with PCS orders, Diplomats & Expatriates please contact your local Volvo retailer, or our Customer Care Center (800) 631-1667 or visit www.volvocars.us/mybagsarepacked

WELCOME TO THE CLUB. THE VOLVO XC60 MERCHANDISE COLLECTION.

This smart collection of lifestyle accessories captures the driving spirit of your new Volvo and reflects the best of modern Scandinavian design. The signature items below are a select few. Find more keepsakes, gifts and apparel at your local Volvo showroom and at www.volvocars.us



Silver diamond tumbler



Fossil grey dial watch



Vintage crew sweatshirt



Portable speaker case



Barriga dome keyring



Workzone lunch cooler



Black barrel ceramic mug



Organic black T-shirt



VOLVO XC60

Design the Volvo
that's really you at
www.volvocars.us



www.twitter.com/VolvoCarsUS



www.facebook.com/VolvoCarsUS



www.youtube.com/VolvoCarsUS

www.volvocars.us

Specifications, features, and equipment shown in this catalog are based upon the latest information available at the time of publication. Volvo Cars of North America, LLC reserves the right to make changes at any time, without notice, to colors, specifications, accessories, materials, and models. For additional information, please contact your authorized Volvo retailer. © 2012 Volvo Cars of North America, LLC. Printed in USA on 100% recyclable paper. **MY13B**

