

VOLVO XC70

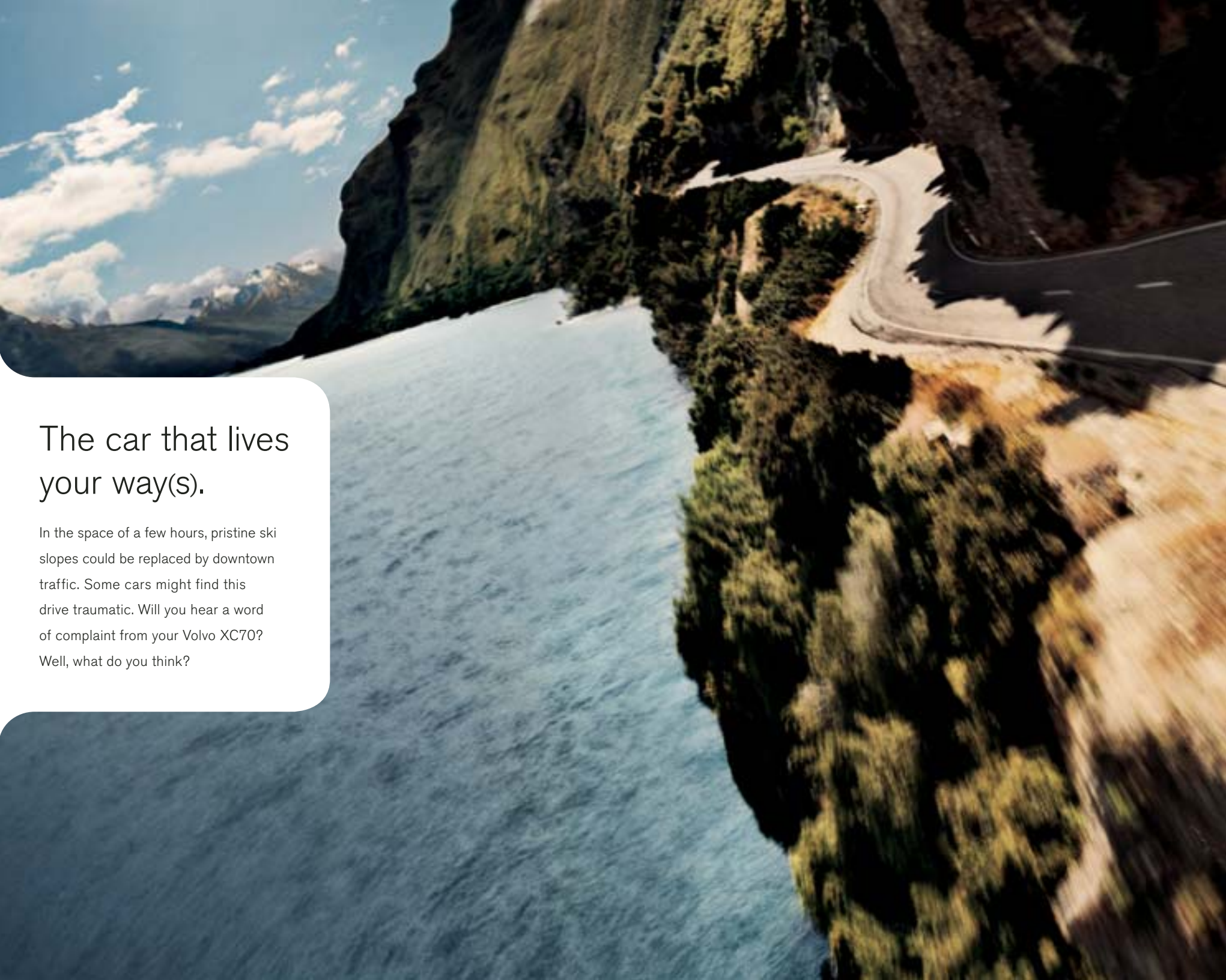

An aerial, high-angle photograph of a winding asphalt road that curves along the edge of a steep, forested cliff. The cliffside is covered in dense green trees and shrubs. Below the cliff, the deep blue ocean stretches towards the horizon. In the background, a range of mountains with patches of snow is visible under a bright blue sky with scattered white clouds. The overall scene conveys a sense of adventure and scenic beauty.

The car that lives your way(s).

In the space of a few hours, pristine ski slopes could be replaced by downtown traffic. Some cars might find this drive traumatic. Will you hear a word of complaint from your Volvo XC70? Well, what do you think?





A couple is walking on a city street during the golden hour of sunset. The woman is wearing sunglasses and a dark jacket, carrying a large red bag. The man is wearing a light-colored coat. They are walking towards the right. In the background, other pedestrians are walking, and a car is visible. The scene is bathed in warm, golden light, creating long shadows on the cobblestone pavement.

At home where you are.

Wherever life – and living it to the full – takes you, the Volvo XC70 leads the way. Think power, refinement, versatility and style in any situation, any time. There was a time when your choice of car had to reflect your lifestyle. Say goodbye to those times.

Life is better lived together.

Volvo. for life



Come alive.

No matter how much it changes, this is one view you'll never grow tired of. Inside the Volvo XC70, intuitive design and facilitating features take you to a place where complexity is simplified and ergonomics and comfort live in harmony. Step inside and come alive.



Volvo Navigation System (VNS) with RTT (Real Time Traffic)*

Volvo's GPS-based VNS navigation system is totally integrated with your car. It offers both voice guidance and graphic navigation all the way to your destination. Via TMC (Traffic Message Channel) radio data broadcasts VNS also lets you know if there's weather or traffic-related trouble on route and recommends an alternative. The VNS system is easily controlled from the steering wheel or a remote, and the screen is positioned so you can keep your attention on traffic. Volvo's Navigation System includes Map Care which provides two map data updates at no charge.

*Maps do not cover all areas or all routes within an area. Also constant expansion and rebuilding of the road network mean that the digital map database is not always the latest road information. Always follow relevant regulations and road information.

Optional, requires Premium Package



Rear Seat Entertainment (RSE) dual screen*

With Volvo's new generation DVD-based RSE dual screen, the rear seat passengers can enjoy a film or play a game – together or separately. Two 8-inch wide-screen displays are integrated in the front seat head restraints and provide excellent image quality. Cordless headphones keep things calm in the cabin and you can listen to the music or program of your choice. Via an AUX input, you can also connect external devices such as an iPod®, MP3 player, extra DVD player or a digital camera. The RSE system is an integrated part of the car. It matches the interior perfectly and is available with all upholstery.

*Optional, requires Premium Package



Integrated Bluetooth® handsfree system

Bluetooth® technology enables a mobile phone to be connected to the infotainment system in your Volvo – wirelessly. Once configured for a mobile phone, the system automatically recognizes your phone as you enter the car. You then operate your phone using the buttons in the steering wheel. As you climb in and out of the car, the system automatically allows you to switch freely from the phone to the handsfree system and back again.

 The Bluetooth word mark and logos are owned by the Bluetooth SIG, Inc. and any use of such marks by Volvo Car Corporation is under license. Other trademarks and trade names are those of their respective owners.





Power liberates.

The turbo engine in the XC70 T6 packs 281 hp of pure breakaway power. The naturally-aspirated XC70 3.2 provides an agile 238 hp. Both engines are mated to the six-speed Geartronic automatic transmission and feature, Haldex AWD all-wheel drive.



Play it safe.

There are many reasons Volvo is synonymous with outstanding safety. The optional Collision Avoidance Package offers you technology that leads the way in terms of accident prevention. It includes Collision Warning with Auto Brake, which is a great example of this. Consider the fact that it also features Driver Alert Control, Lane Departure Warning, Distance Alert and Adaptive Cruise Control, you might find it hard to believe you ever considered traveling any other way.

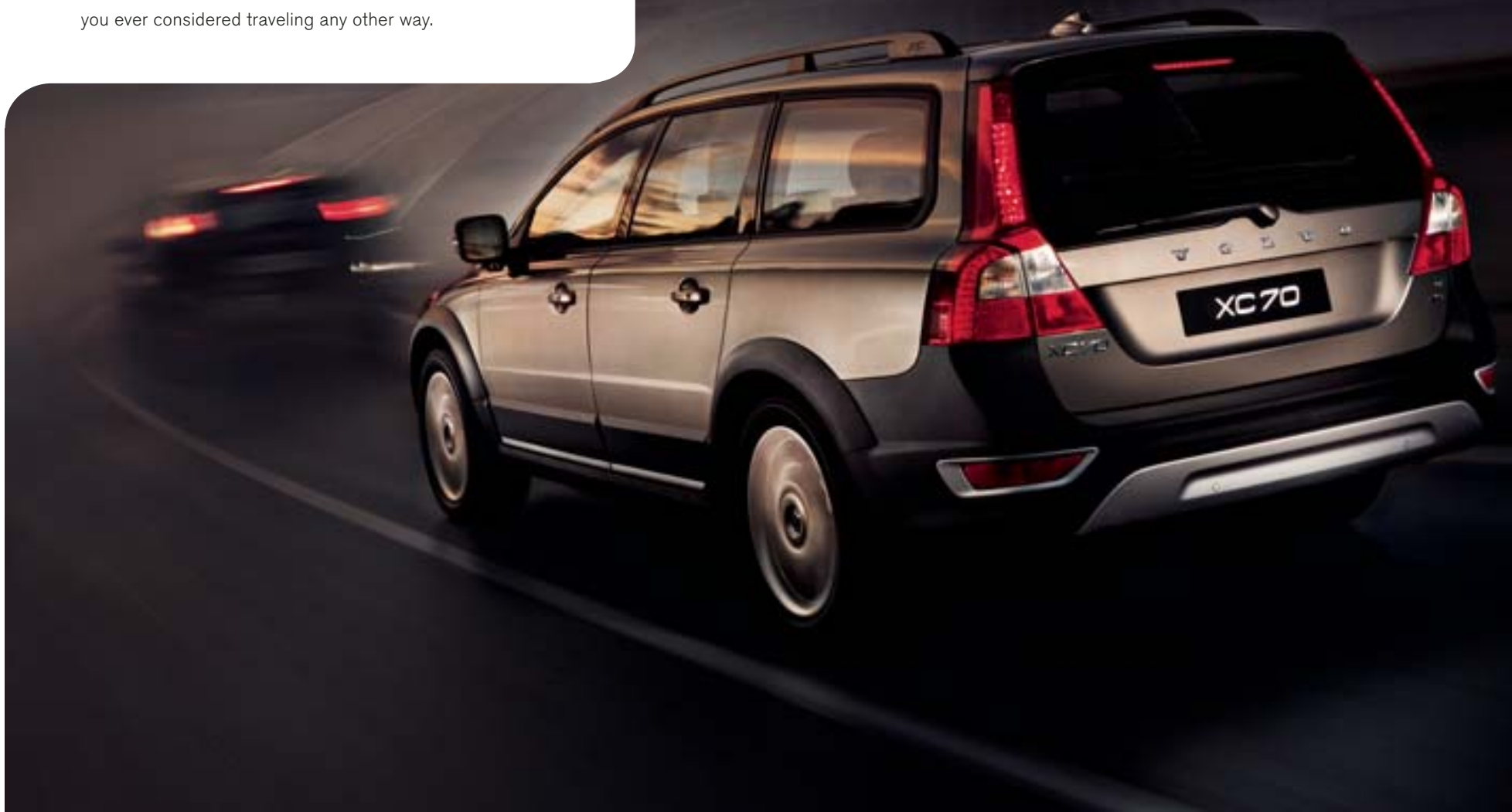

Life engineering.

Versatility. A word you hear quite often in the context of cars but one that takes on a whole new meaning in the case of the Volvo XC70. Especially when considering loading. Take the Volvo XC70's 40/20/40 split rear seats for example. The flexibility they deliver in terms of combining cargo and passengers let's you load up without compromising comfort or safety. They also leave a lot of room for something equally important – life. Or perhaps we should say 'lives'.





40/20/40 split rear seat

The rear seats feature 40/20/40 splits that provide two distinct seats with a solid armrest in the middle. This armrest can also be raised to provide a middle seat. Lowering the entire center section provides ample space for loading long items. To provide multiple load configurations with a flat load floor, each seat can be folded separately or together. What's more, the rear seats only take one step to maneuver.



Going downhill was never this uplifting.

Hill Descent Control is one of the Volvo XC70's outstanding features. By simply pushing a button, it offers smooth, controlled and safe descents on steep, rough roads. The system controls braking on each wheel, allowing you to concentrate fully on steering. Away from the wilderness, Hill Descent Control is also useful when descending a steep boat ramp.





Believing is hearing.

What's the most attractive feature of the XC70's Dynaudio Premium Sound System*? Is it the twelve-speaker system from renowned Danish sound specialist, Dynaudio? Perhaps it's the Dolby® Pro Logic® II surround sound. Or how about the 5x130W digital class D amplifier? Maybe it's something simpler. Like the fact that wherever you sit in the XC70, music sounds just exactly the way it should. Your way.

*Available in the optional Technology Package



Dynaudio loudspeakers

The twelve high-end loudspeakers by the Danish sound specialist Dynaudio in the Premium Sound system are powered by a 5x130 W digital amplifier. There are three separate drivers – woofer, midrange and tweeter – in each front door. In the rear doors there is a similar set-up with a woofer and tweeter and there's an available 260-watt subwoofer you can feel. Each speaker has its own crossover filter to harmonize with the others. The latest generation Dolby® Pro Logic® II surround sound uses the center loudspeakers (woofer and tweeter) and a sound processor to recreate authentic sound with a strong sense of presence for everyone in the car. The digital class D amplifier features new technology to provide extremely high efficiency, enabling it to generate the most audio power from the least amount of current.

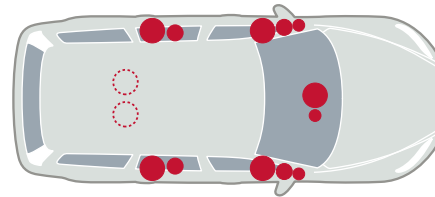

Dynaudio Premium Sound System (optional)

This is our top-of-the line audio system designed for dynamic clarity with the entire sound spectrum. This system features twelve loud-speakers by Danish sound specialist Dynaudio. In addition, Dolby® Pro Logic® II Surround helps tailor a well-balanced audio experience for each occupant. Premium Sound includes:

- In-dash 6-CD changer
- SIRIUS Satellite Radio
- 5x130 W digital class D amplifier
- Dolby® Pro Logic® II Surround
- 12 Premium Sound loudspeakers by Dynaudio
- MP3 and WMA compatible CD player
- AUX input

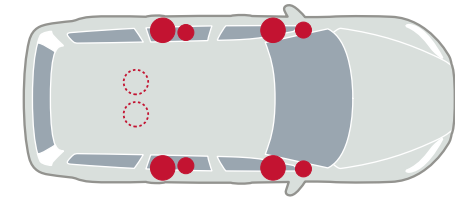

High Performance (standard)

This is a powerfully versatile system. Each loudspeaker is fitted with a more powerful magnet and a larger coil. In combination with the amplifier, this system promotes excellent transient reproduction and high power – quite simply superb sound. This High Performance system includes:

- In-dash CD
- 4x40 W amplifier
- 8 High Performance loudspeakers
- MP3 and WMA compatible CD player
- AUX input



Volvo satellite radio

Satellite radio is now available for your Volvo. Volvo has joined forces with Sirius to offer an integrated satellite solution that is sure to provide endless listening enjoyment.

Now and again we like to reduce pulse rates.





When you leave your XC70, you might find that you pause for a moment. More out of reflection than concern, might we add. Consider the fact that features such as a remote alarm, Personal Car Communicator* and Home Safe Lighting place this car in a security class of its own – whether you're inside the car or a hundred miles away. With the PCC, the XC70 is even equipped with a heartbeat sensor, which alerts you to the presence of any intruders in the cabin by sending a message to the remote key. After you've considered all this, you can happily go on your way and let us take care of security.

* Optional



Safety comes naturally.

It's in the genes – an uncompromising ambition to both protect and celebrate life. It's human nature. And it's what makes a Volvo a Volvo. For decades, we've created cars that both encourage people to enjoy life and offer protection in the event of an accident. In fact, thousands of people all over the world can say they're still alive because of a Volvo. This is not by coincidence. Our founders stated that safety is, and will always be, at the heart of what we do. As a result, Volvo is recognized the world over for our passion to provide the safest cars on the road.

The protective character of a Volvo also encompasses the world we share. As far back as 1972, Volvo was the first car manufacturer to acknowledge the environmental downside of cars. Since then, we've been committed to reducing the environmental impact of the cars we make and how we make them. Therefore, choosing a Volvo will never be something you do just for yourself. Not that you can't, but our cars will always consider the well-being of more than one. Even if those people happen to be outside your car or are part of future generations. It's just the way we are.

Innovations for life.

- In 1959, Nils Bohlin, a Volvo safety engineer, invented the three-point seat belt. So important is this invention that it is considered to be one of the most life-saving technical innovations in the history of mankind.
- In 1976, Volvo Cars was the first car manufacturer to introduce the three-way catalytic converter with an oxygen sensor for exhaust emission control. Today virtually all gasoline-powered cars are equipped with this ingenious component – just as indispensable for the environment as the three-point seat belt is for safety.

These are only two examples of Volvo's most important safety and environment innovations. You'll find a lot more on www.volvocars.com/corporation

"Cars are driven by people. Therefore, the guiding principle behind everything we make at Volvo is – and must remain – safety."

*Assar Gabrielsson and Gustaf Larson,
founders of Volvo*



After 36,000 crashes, you begin to know what you're doing.

The best way to learn what really happens before, during and after a car crash, is to be there. Since 1970, Volvo's Accident Research Team has investigated accidents involving Volvo cars on Swedish roads. Today, our own statistical database contains over 36,000 accidents with more than 60,000 occupants.

Our accident researchers are on stand-by 24/7. If there's an accident involving a newer Volvo car within 60 miles of Göteborg, our researchers are instantly alerted by the rescue team. In addition to studies on the scene of the accident, our researchers also investigate what happened before the crash to understand how to improve the driver's ability to avoid a collision.

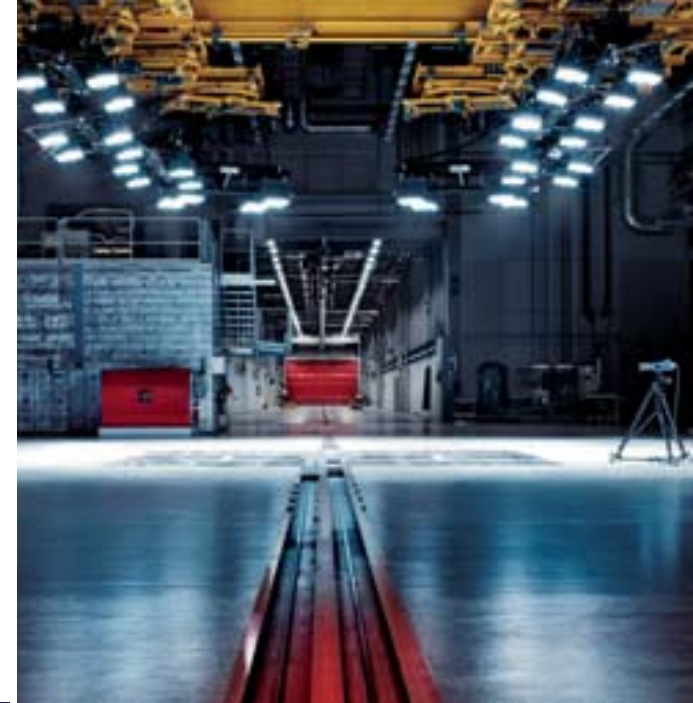

Volvo Cars Safety Center – the world's most advanced crash laboratory

Based on the findings from our accident research, we can recreate a variety of real-life traffic situations and crashes. Beyond numerous virtual crash tests in super-computers, we perform around 450 crashes each year. We crash test car-to-car at different speeds and with other kinds of vehicles and road obstacles. We perform frontal impacts, rear impacts, side impacts and roll-over tests and test cars off-road as well as against genuine Swedish granite rock-face – we can even simulate impacts with wild animals.

If you make it here, you make it anywhere

Other car manufacturers come to Sweden for final car testing under harsh and capricious conditions. For us it's home. Our own proving ground Hällered with its 34 miles of test tracks includes different road types from all over the world. Here we scrutinize our cars' ability to support their drivers in all imaginable and unimaginable situations during thousands of test miles – not to mention the distances driven on ordinary Swedish roads.



Advanced technology to support the human factor.

After all, we're only human. That's why we build cars that help support you in different situations, with technology that expands the human senses and helps you to focus on driving. Still, technology will never take the responsibility away from you as driver. Final decisions are always in your hands. But if these technologies help make you more alert and relaxed as driver, they will also contribute to the overall safety of those in and around your Volvo.

Collision Warning with Auto Brake* for highway driving is Volvo's radar and camera based technology that can warn you if you're too close to a vehicle in front of you and – if a collision can't be avoided – can activate the brakes to help reduce the effects of a crash.

Driver Alert Control (DAC)* is a unique technology designed for highway driving and can remind you if you're losing concentration.

Lane Departure Warning (LDW)* monitors your car's position on the road and helps alert you if you unintentionally are crossing a lane marker at speeds over 40 mph.

Dynamic Stability and Traction Control (DSTC) helps you maintain traction in a wide range of situations and prevent the car from skidding.

All-wheel drive with Instant Traction™ continuously distributes power to the wheels with the best traction for reassuring stability in a wide range of conditions.

Adaptive Cruise Control (ACC) with Distance Alert is designed for smooth traffic flow and can be activated at speeds over 19 mph. Just select the desired speed and the minimum time gap to the vehicle in front. When the radar sensor detects a slower vehicle in front, the speed automatically adapts to that vehicle. If ACC is disengaged and a vehicle in front comes too close, Distance Alert activates a red warning light in the lower section of the windscreen to help you keep a proper distance.

*Included in the optional Collision Avoidance Package

Blind Spot Information System (BLIS) (optional) helps to detect vehicles entering the blind spot on both sides of your car.

Dual Xenon with Active Bending Lights** expand your vision range by about 230% when you're driving in the dark and provide considerably improved illumination around bends.

Emergency Brake Light (EBL) senses a panic braking maneuver and causes the brake lights and an additional taillight on each side of the vehicle to illuminate to help alert traffic approaching from behind.

Hydraulic Brake Assist (HBA) ensures optimal braking power to help you stop the car in the shortest possible distance.

Ready Alert Brakes (RAB) anticipate an emergency braking to further help reduce the braking distance.

Intelligent Driver Information System (IDIS) can help reduce your workload in stressful situations.

**Included in the optional Technology Package

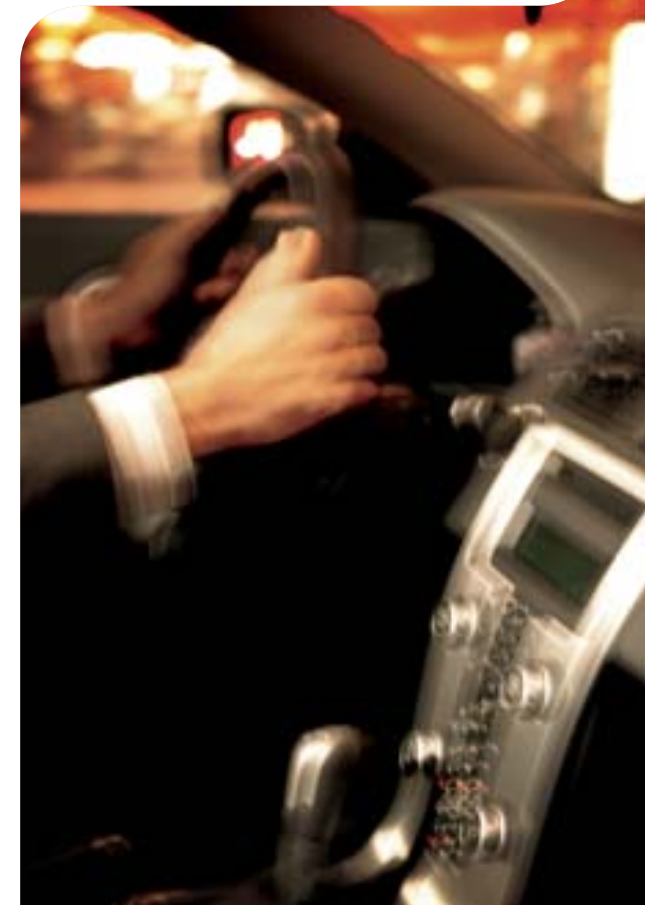

Did you know that:

- a third of all reported accidents are rear impact – and in more than 50% of these accidents the driver doesn't brake at all.
- up to 90% of all traffic accidents are caused by driver distraction.
- gas discharge light technology (Xenon) helps you gain 148 ft of illumination when driving in the dark.



Our engineers spent more than 80 years designing this car.

You're looking at one of the safest cars in the world. Not because this car displays the highest number of airbags in the industry (it probably doesn't), but because of how well the different safety technologies interact to keep the occupants out of harm's way. What's more, what you see is the result of the collected efforts from generations of dedicated Volvo safety engineers. So if you share our passion for safety, this may be the most exciting image in the whole brochure.

In a frontal collision the patented frontal structure will yield to help absorb crash energy, while longitudinal steel struts in the doors helps disperse crash energy away from the front to the rear of the car. The compact power train is designed to help optimize deformation. Inside the car, seat belts interact with the collapsible steering column and multi-stage airbags to help keep the occupants out of harm's way. A lower cross member helps protect occupants in an oncoming car with lower positioned bumpers.



In a roll-over the extremely sturdy safety cage and reinforced roof structure will help protect the occupants while the seat belts help keep them restrained in their seats. If the car first has been hit from the side, the Inflatable Curtain (IC) deploys to help provide head protection and help keep the occupants inside the cabin.

In a side impact Volvo's unique Side Impact Protection System (SIPS) helps protect the occupants. The extremely strong door and side structure is designed to help withstand a severe side impact – even with a larger vehicle. The dual-chamber side airbags in the front seats help protect the chest and hip, while the Inflatable Curtain (IC) adds head protection.

In a rear impact the rear deformation zones will help absorb crash energy. The fuel tank is designed to remain well protected in front of the rear axle. The head restraints help protect the neck and spine, and Volvo's unique Whiplash Protection System (WHIPS) cradles the front seat occupants in a controlled manner to help prevent whiplash injuries.



Maximize your experience. Not your carbon footprint.

We believe it's more fun to drive a car that cares both for people and the environment – be it outside or inside the vehicle. Utilizing advanced engine technology and emission control, the Volvo engines are designed to combine high performance with low environmental impact. This caring attitude continues inside your Volvo. Here you and your passengers can experience one of the automotive industry's cleanest and healthiest cabin environments. It's as enjoyable as it's responsible. Just as you would expect of a Volvo.





Emission controls

All Volvo engines comply with stringent international environmental requirements. Advanced emission control eliminates between 95 and 99% of carbon monoxide, hydrocarbons and nitrogen oxides from engine exhaust gases. The catalytic converter is positioned to provide optimum exhaust conversion sooner after cold starting.

Low emission interior

To ensure that you and your passengers are not exposed to harmful emissions or unpleasant odors, we test individual upholstery and interior trim items as well as complete interiors in the Volvo Environmental Laboratory in Sweden. All upholstery materials and interior textiles also comply with Oeko-Tex Standard 100 – an international benchmark for human ecological safety of textiles. All leathers are tanned by a process that only uses vegetable or synthetic substances instead of chromium. In addition, several interior details made of metal are tested for contact allergies – they even meet the same nickel leakage requirements as jewelry.

Clean cabin air

A cabin air filter removes dust, pollen and other particles from the incoming air. Volvo's Interior Air Quality System (IAQS)* continuously monitors incoming air and can shut out carbon monoxide, ground-level ozone and nitrogen dioxide. This helps to ensure that the air you breathe in the cabin is cleaner than that outside the car when driving in heavy city traffic and tunnels.

* Included in the optional Convenience Package

DRIVE

Factory-installed options.

The sense of quality and care – and knowing that you get the Volvo that suits your lifestyle. Customize your car with the options that best meet your demands and desires, and you'll soon be behind the wheel of your individually tailored Volvo XC70.



1 Personal Car Communicator (PCC)*

PCC is an advanced remote control that combines keyless drive with two-way communication with your Volvo. Keep the PCC with you and the car unlocks automatically on your arrival. Start the engine by pressing a button on the dash, lock the car by pressing a button in the door handle. Later in the day, if you're wondering whether you've locked the car, PCC can remind you; no matter where you are. On your return to the car – within a radius of 195 to 330 ft – pressing the PCC information button will give you a current report on its status. If the alarm has been activated, the onboard heartbeat sensor will give you advanced warning if there's somebody in your car and an opportunity to evaluate the situation safely.

2 Blind Spot Information System (BLIS)*

BLIS is designed to help the driver keep a lookout on either side of the car. As a vehicle enters your blind spot, this function can alert you with an indicator light built in to the front door pillar – left or right. Together with the door mirrors, BLIS helps you assess the feasibility of a lane change. BLIS is activated once the car exceeds 6 mph, and reacts to almost any type of vehicle from a motorcycle upwards, day or night.

*Optional

3 Sirius satellite radio

Satellite radio is now available for your Volvo. Volvo has joined forces with Sirius to offer an integrated satellite solution that is sure to provide endless listening enjoyment.

4 Volvo Navigation System (VNS) with RTT (Real Time Traffic)*

Volvo's GPS-based VNS navigation system is totally integrated with your car. It offers both voice guidance and graphic navigation all the way to your destination. Via TMC (Traffic Message Channel) radio data broadcasts VNS also lets you know if there's weather-related trouble on route and recommends an alternative. The VNS system is easily controlled from the steering wheel or a remote, and the screen is positioned so you can keep your attention on traffic. Volvo's Navigation System includes Map Care which provides two map data updates at no charge.

*Maps do not cover all areas or all routes within an area. Also constant expansion and rebuilding of the road network mean that the digital map database is not always the latest road information. Always follow relevant regulations and road information.

5 Minos Alloy wheels

7.5x18" Silver Bright, Optional T6

6 Sargas Alloy wheels

7.5x17" Silver Bright, Standard T6, Optional 3.2

7 Two-stage integrated booster cushions (33-80 lbs)

These integrated booster cushions help ensure that children sit comfortably and safely. They position children at the correct height for the seat belt and adjust to two heights to accommodate children of different sizes, so smaller children can be seated higher to enjoy a more comfortable ride. And as the children grow, seat height can be adjusted accordingly. This optimizes seat belt geometry, and will – together with the built-in progressive seat belt load limiter – help reduce the strain on the child's neck and chest in an impact. The booster cushions conveniently fold up from the outboard rear seats and are easily folded into the rear seat cushion when they're not needed.

8 Rear Seat Entertainment (RSE) dual screen

With Volvo's new generation DVD-based RSE dual screen, the rear seat passengers can enjoy a film or play a game – together or separately. Two 8-inch wide-screen displays are integrated in the front seat head restraints and provide excellent image quality. Cordless headphones keep things calm in the cabin and you can listen to the music or program of your choice. Via an AUX input, you can also connect external devices such as an iPod®, MP3 player, extra DVD player or a digital camera. The RSE system is an integrated part of the car. It matches the interior perfectly and is available with all upholstery.

Volvo's accessories help you make your Volvo XC70 even more suited to your personal needs. They are the only ones that have been tested to meet Volvo's exacting safety, quality and environmental requirements. You can also rest assured they're a perfect match to the technology and design of your Volvo.

Accessories.



For Driving Freedom

- Moon roof wind deflector
- Park assist, front and rear
- Parking assistance camera
- Portable navigation system

For Your Entertainment

- 6 Disc in dash CD changer
- Rear Seat Entertainment System with Dual DVD player
- Satellite Radio
- Volvo USB/iPod music Interface

For Precious Cargo

- Booster cushion and backrest
- Child activity bag
- Child mirror
- Padded neck cushion
- Rear center armrest table
- Sun screen, cargo area
- Sun screen, rear doors

For Your Leisure

- Ashtray, front and rear
- Bike carrier, roof mounted
- Business bag organizer
- Canoe/Kayak carrier, roof mounted
- Cargo box, roof mounted
- Cargo management system
- Dirt cover, rear bumper
- Floor mats, rubber
- Grocery bag holders
- Integrated cooler/hotbox
- Load basket, roof mounted

- Luggage compartment mats
- Net pocket, side panel cargo compartment
- Net, luggage compartment floor
- Portable electric cooler/hotbox
- Protective grille steel
- Rear seat guard
- Roof mounted "Load Bar" carrying system
- Seat cushions, rear cargo area
- Ski carriers, roof mounted
- Snowboard carrier, roof mounted
- Sun glasses holder
- Surfboard carrier, roof mounted
- Trailer hitch mounted bike carrier
- Trailer hitch mounted load basket
- Trailer hitch mounted ski carrier
- Trailer hitch step
- Trailer hitch, 2" Square profile
- Floor mirrors
- Tunnel mat, second row seats

For Your Looks

- Aluminum wheels
- Chrome wheels
- Footboard, moldings, illuminated
- Interior décor panel kits
- License plate frames
- Locking lug nuts
- Roof spoiler
- Side scuff plate
- Valve stem caps
- Wood steering wheel

For Unexpected Situations

- Car cover
- Electric engine heater
- First aid kit
- Jumper cables
- Leather care kit
- Mud flaps, front and rear
- Snow chains
- Warning triangle

Interior selection.



Leather Offblack upholstery (F100)
Modern wood trim center console and door panel inserts



Sundby Textile/T-Tec Offblack upholstery (F500)
Dark fineline trim center console and door panel inserts



Dark Fineline trim
Standard 3.2

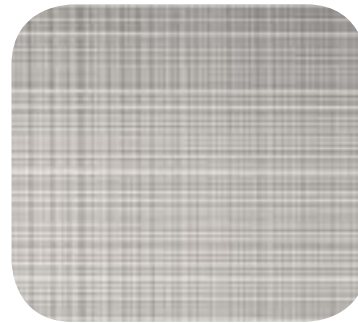

Cross brushed aluminum trim
Standard T6



Modern wood trim
Included in Premium Package

There are two different interior color themes to choose from – Offblack and Sandstone Beige. The dashboard and other interior details are color coordinated with the upholstery. For extra contrast, the Sandstone Beige interior offers a brown upholstery option. The front center armrest and interior door panels are color coordinated with the seats and upholstered in matching material.



Leather Sandstone Beige upholstery (F112)
Modern wood trim center console and door panel inserts



Sundby Textile/T-Tec Mocca Brown upholstery (F514)
Dark fineline trim center console and door panel inserts



Leather-clad steering wheel,
Offblack



Leather-clad gear knob
Offblack, Geartronic



Leather-clad gear knob
Sandstone Beige, Geartronic



Leather-clad steering wheel,
Sandstone Beige

Exterior design.



Side scuff plate*

The matt aluminum finish side scuff plates add an extra touch of attitude to the Volvo XC70 – perfectly matching the design of the sill and other XC70 exterior styling details.



Minos 7.5x18" Silver Bright
Optional T6



Sargas 7.5x17" Silver Bright
Standard T6, Optional 3.2



Cecino 7x16" Silver Stone
Standard 3.2

*Retailer installed accessory

Aluminum crossbars*

An aerodynamic design element that complements the roof rails and the design of your Volvo. These aluminum crossbars also allow you to exploit the roof's load-carrying capacity to the full.



Roof spoiler*

The stylish roof spoiler enhances the sporty lines of your Volvo wagon and is color-coordinated with the body.

Standard features.

SAFETY	XC70 3.2 AWD	XC70 T6 AWD
ABS Anti-lock Brakes with EBA	●	●
Anti-submarine seats	●	●
Cargo security cover	●	●
Daytime running lights (halogen semi-sealed with replaceable bulb)	●	●
Driver and front passenger supplemental restraint system—multi-threshold air bags	●	●
Dynamic Stability and Traction Control (DSTC)	●	●
Electric Parking Brake	●	●
Hill Decent Control	●	●
IDIS Intelligent Driver Information System	●	●
Illuminated side marker lights/turn signal indicators	●	●
Immobilizer, encrypted ignition key	●	●
Inflatable side curtain (IC)	●	●
ISOFIX baby/child seat attachment system	●	●
Rear fog light with auto-off	●	●
Safe approach and home safe lighting	●	●
Seat belts: five, 3-point inertia-reel belts with automatic pretensioners; front belts have height adjustment	●	●
Seat belt reminder	●	●
Security system	●	●
Side impact air bags for driver and front passenger (SIPS bags II™)	●	●
Side impact protection system (SIPS)	●	●
Top-tether child seat anchorage capability	●	●
Tire Pressure Monitoring System (TPMS)	●	●
Whiplash protection seating system (WHIPS)	●	●
INTERIOR		
Auto Dimming Rearview Mirror	●	●
Bluetooth® handsfree system	●	●
Central power door locks with remote control, tailgate and fuel filler door locks	●	●
Cruise control	●	●
Cup holders	●	●
Dual-zone electronic climate control (ECC)	●	●
Five padded head restraints	●	●
Four reading lights	●	●
Front 12-volt power outlet	●	●
Front center armrest	●	●
Front door-panel storage pockets	●	●
Front seat-back storage pockets	●	●
High Performance Audio System with In-dash CD 8 speakers	●	N/A
High Performance Audio System with In-dash 6 CD changer, 8 speakers	N/A	●
Illuminated lockable glove compartment	●	●
Illuminated vanity mirrors in driver/front passenger sun visors	●	●
Interior cabin light delay	●	●
Leather-clad steering wheel	●	●
Leather-clad gear lever knob	●	●
Luggage/cargo area lights	●	●
Outside temperature gauge	●	●
Pollen filter	○	○

Power-adjustable driver seat, 8-way with 3-position memory and lumbar support	●	●
Power windows with driver and passenger auto up/down with anti-trap feature	●	●
Rear seat ventilation outlets on B-pillar	●	●
Rear window defroster with automatic timer	●	●
Tilt/telescopic steering wheel with illuminated cruise and audio controls	●	●
Two entry lights (in front door footwells)	●	●
Watch Dial Instruments	N/A	●
XC Seat and door panel stitching	●	●
XC Floor and cargo mats	●	●
40/20/40 split-folding rear seat	●	●
EXTERIOR		
Dual Exhaust End Pipes	N/A	●
Front and rear skid plates	●	●
Front fog lights	●	●
Power-adjustable heated exterior rearview mirrors	●	●
XC Body trim	●	●
XC Grille	●	●
XC Roof rails	●	●
16" Cecino alloy wheels	●	N/A
17" Sargas alloy wheels	○	●

● = Standard ○ = Option N/A = Not available

The Bluetooth word mark and logos are owned by the Bluetooth SIG, Inc. and any use of such marks by Volvo Car Corporation is under license. Other trademarks and trade names are those of their respective owners.

Factory options.

EXTERIOR	XC70 3.2 AWD	XC70 T6 AWD
Metallic paint	○	○
BLIS (Blind Spot Information System)	○	○
18" Minos alloy wheels	N/A	○
Dual outboard two-stage child booster seats and power child locks	○	○
PCC (Personal Car Communicator)	○	○
Satellite radio prep Sirius™	○	○
Volvo dual-screen RSE (Rear seat Entertainment)*	○	○
VNS (Volvo Navigation System)*	○	○

○ = Option *Requires Premium package

Packages.

CLIMATE PACKAGE

In a Volvo you're always prepared to deal with the ever-changing forces of nature. And to increase comfort when driving in cold, rain or snow – simply add the Climate Package.

- Heated front seats
- Heated rear seats*
- Heated windshield washer nozzles
- Headlight washers
- Rain sensor

*Not available together with two stage booster cushions



CONVENIENCE PACKAGE

The wide range of considerate and practical features makes life with your Volvo a truly enjoyable experience. And by adding the Convenience Package, you expand your freedom even more.

- Grocery bag holder, cargo area
- Sunglass Holder
- Humidity sensor for ECC System
- IAQS (Interior Air Quality System)
- Tinted rear windows
- Park assist, front and rear
- Power operated tailgate
- Private locking
- 12 volt outlet, cargo area

Premium Package

A Volvo offers you long, relaxed drives and more spirit in your daily life. The Premium Package will provide you with some necessities for that extra ambience and convenience.

- Audio dimming mirror with compass
- Modern wood inlays
- Homelink™
- Leather seating surfaces
- Power glass moonroof
- Power passenger seat

TECHNOLOGY PACKAGE

Wherever the road may take you, adding the Technology Package to your Volvo helps you to see the twists and turns and keeps you entertained along the way.

- Dual Xenon with Active Bending Lights
- Sirius™ Satellite Radio
- Rear seat headphone jacks and audio controls
- Dynaudio Premium Sound System*

*Includes MP3 and WMA compatible in-dash, 6-CD player, 5x130W digital class D amplifier, Dolby Pro Logic II Surround, 12 speakers

COLLISION AVOIDANCE PACKAGE*

This package of Collision Avoidance Driver Support Systems is designed to help assist a driver in avoiding potential accidents caused by driver distraction. This unique package offers five support systems.

- Adaptive Cruise Control
- Collision Warning with Auto Brake
- Distance Alert
- Lane Departure Warning
- Driver Alert Control

*Requires Premium package

Volvo XC70 specifications.

ENGINE

Six-cylinder ,in-line, all-aluminum engines.

Double overhead cam-shafts, 24 valves with Variable Valve Timing (VCT). These engines also feature Variable Intake System (VIS) and Cam Profile Shifting (CPS) on the intake camshaft. Electronic engine management system. Three-way catalytic converter with heated oxygen sensor.

These highly compact, in-line, six-cylinder engines meet high expectations in terms of performance, comfort and environmental care. Their smooth running and responsive character provides a relaxed yet responsive drive at all speeds. Advanced engine technology, such as a new intake system, helps increase torque over a wide speed range and ensures power at high rpm. On the T6, twin-scroll turbocharger technology provides extremely quick turbo boost. And depending on your driving style and the situation, the intake valve train automatically switches between economy and performance modes to optimize efficiency. The engines' compact design aids safety performance in a frontal collision. The latest generation of fast response emission control technology ensures that the engines comply with stringent environmental standards such as California's ULEV II.

Volvo XC70 T6 AWD (281 hp)

Engine type: 3.0-liter in-line six-cylinder turbo chared engine
Max power output: 281 hp at 5600 rpm
Max torque: 295 ft./lbs. at 1500 – 4800 rpm
Acceleration: 0-60 mph N/A
Top speed: N/A
Fuel consumption, MPG, mixed cycle: N/A
Environmental classification: ULEV II
Transmission: Six-speed Geartronic automatic

Volvo XC70 3.2 AWD (235 hp)

Engine type: 3.2-liter in-line six-cylinder engine
Max power output: 235 hp at 6200 rpm
Max torque: 236 ft./lbs. at 3200 rpm
Acceleration: 0-60 mph N/A
Top speed: N/A
Fuel consumption, MPG, mixed cycle: N/A
Environmental classification: ULEV II
Transmission: Six-speed Geartronic automatic

DRIVELINE

Electronically controlled all-wheel drive (AWD) with Instant Traction™. A six-speed Geartronic automatic (allowing manual shifting). Power is continuously distributed to all four wheels by Volvo's pre-charged electronically controlled AWD with Instant Traction™. This minimizes wheel spin for immediate acceleration and reassuring stability in all conditions. The six-speed Geartronic—a responsive automatic that's ideal for relaxed driving, tough conditions or towing. This also allows manual gear shifting so you can maintain a lower gear to bring up engine speed, or for the added assistance of engine braking. A special winter setting makes it easier to move off and maintain grip on slippery surfaces. The standard Hill Descent Control (HDC) offers a smooth and controlled hill descent on steep, rough roads using the brake system to control each wheel's speed.

CHASSIS

Front suspension with spring struts (McPherson), anti-dive and anti-lift function. Active multi-link independent rear suspension. Anti-roll bars front and rear. DSTC (Dynamic Stability and Traction Control).

The Volvo XC70's all-road capability is based on generous ground clearance 8.2 inches, a low center of gravity and an advanced chassis. The rigid body promotes optimal suspension function and well-balanced handling with a high level of comfort. The front and rear suspensions also interact to provide smooth braking and steering. The DSTC stability system provides assistance if either of the drive wheels begins to lose traction or if a skid is imminent.

STEERING

Power-assisted hydraulic rack and pinion steering. Tilt and telescopic steering wheel column. 2.8 turns lock to lock.

Behind the wheel, you can enjoy steering that's both responsive and reassuring at all speeds. The optional speed dependent power steering gives progressively less power assistance the faster you drive. Higher steering precision and enhanced road feedback are easily enjoyed benefits. At lower speeds, added power assistance makes the car even easier to maneuver, for instance when parking.

BRAKES

Power-assisted anti-lock disc brakes (ABS), ventilated discs front. OHB (Optimized Hydraulic Brakes). HBA (Hydraulic Brake Assist). RAB (Ready Alert Brakes). FBS (Fading Brake Support). EBD (Electronic Brake Distribution) between the front and rear brakes. Diagonal-split braking system. Power Parking Brake (PPB).

Generously dimensioned anti-lock disc brakes and optimized hydraulics help to ensure a short stopping distance in all situations. Furthermore, they withstand tough use without fading. HBA helps you use your brakes to the full in an emergency situation, while RAB anticipates severe braking and prepares for it by moving the brake pads closer to the discs. FBS automatically compensates for the higher pedal forces required after long periods of heavy braking. EBD distributes the braking effect between the front and rear wheels to achieve optimal results according to load and driving conditions. The Power Parking Brake (PPB) makes moving off from steep gradients easier. Once depressed, the PPB control lever automatically releases as the car pulls away. It can even be set to engage automatically as you extract the key.

Fuel tank

18.5 US Gallons

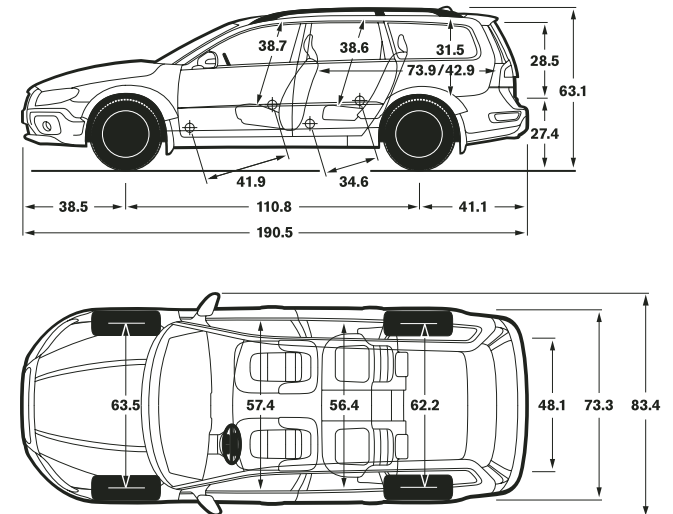

Meet the family.

S



Volvo S40 The compact and energetic sedan.



Volvo S60 The sports sedan worth getting passionate about.



Volvo S80 The premier sedan, meticulously engineered for superior driving comfort.

V



Volvo V50 The Sportswagon – flexible, compact and full of zest.



Volvo V70 The genuine family wagon – highly competitive yet comfortably versatile.

XC



The new Volvo XC60 A sporty coupe and a capable all-roader fused into a Swedish crossover experience.



Volvo XC70 The rugged yet stylish all-roader.



Volvo XC90 The versatile SUV that takes you anywhere with grace.

C



Volvo C30 The compact and charismatic SportsCoupe.



Volvo C70 A convertible when you want it.



Volvo C70 A coupe when you need it to be.

To live life is to care about it.

Every moment in a Volvo is a moment designed to celebrate life. A life full of twists and turns, ups and downs; the little things as well as the big ones. Of course, to live life to its fullest isn't just about you; caring for others is important as well.

For more than eighty years we have helped save lives on roads around the world. Nevertheless, when it comes to improving automotive safety, we will never be satisfied. And while we're seeking new solutions, our existing safety systems are preventing many accidents from happening and providing some real protection when they do.

Our passion for life means looking after our children's children, too. Which is why we try to balance the needs of our company with those of society. With this bigger picture in mind, we develop engines and technology that have less impact on mother earth. This approach also explains why we pay so much attention to your immediate environment – in the car. Simply put, we care about you – and the whole circle of life.

Taking care of your ownership needs.

It's a simple idea; one point of contact for all your car ownership needs, whether it's finding the right financing or who to contact in an emergency. Get the most out of owning your Volvo.

Volvo Car Finance North America

If you purchase or lease your Volvo through Volvo Car Finance North America, you can take advantage of services designed to make financing simple and convenient. Quick Debit, for instance, enables you to have your monthly payment automatically debited from a designated bank account. For more information, call 1-800-770-8234 or visit www.volvofinance.com

On Call roadside assistance

Whenever you need us, we're just a phone call away. Our nationwide network of retailers and authorized service providers are ready to assist. Whether you require roadside assistance or maps and routing information for your next trip, refer to your On Call Card and dial 1-800-63-VOLVO – anytime, day or night. Your complimentary four-year membership activates the moment you become a Volvo owner.

Volvo new car warranty

Your new car warranty provides comprehensive coverage for four years or 50,000 miles, whichever occurs first. Additional warranties cover corrosion, seat belts, the supplemental restraint system, emission systems, genuine Volvo replacement parts and genuine Volvo accessories. Should you encounter any problem with your Volvo, simply contact the nearest retailer for assistance. Where your warranty ends, Volvo Increased Protection (VIP) plans begin. To purchase the additional protection of a VIP plan, contact your local retailer.

Complimentary Factory Scheduled Maintenance

Volvo is committed to a premium ownership experience for its customers. To further enhance your ownership experience, all 2009 model year Volvo's sold new through Volvo retailers in the United States will include Complimentary Factory Scheduled Maintenance. This program provides scheduled maintenance coverage for the first 3 years or 36,000 miles, is designed to compliment your Volvo warranty, and will help ensure trouble free operation of your Volvo. Coverage includes factory recommended maintenance including oil and filter changes, checks and adjustments as listed in your Warranty and Maintenance Records Information booklet, for the first four maintenance services at intervals of 7,500, 15,000, 22,500 and 30,000 miles

Service must be performed within 1,500 miles before or after each scheduled interval. Coverage is limited to scheduled maintenance items listed in the 2009 model year Warranty and Maintenance Records Information booklet. Normal wear items such as brake pads and wiper blades are not covered under the Complimentary Factory Scheduled Maintenance. An authorized retailer must perform maintenance. Offer is transferable.

Optional Factory Scheduled Maintenance program upgrades are also available that will allow you to customize coverage to meet your driving needs. See your Volvo retailer for details.

Volvo genuine service

The best way to ensure superior performance year after year is to bring your Volvo to your authorized retailer for regular maintenance. Our service advisors and factory-trained technicians are uniquely qualified to maintain your automobile. With the aid of advanced Volvo diagnostics, they follow all prescribed factory maintenance outlined in your service interval manual. Genuine Volvo Service is our ongoing commitment to you: to keep your Volvo performing smoothly long after other cars have given up.

Volvo mobility program

The goal of the Volvo Mobility Program is to assist persons with physical disabilities or hearing impairment achieve independence. For those with exceptional transportation needs, freedom can be facilitated within the extraordinary comfort and safety of a specially adapted Volvo. For additional information on this program, please contact the Volvo Mobility Program Headquarters at (800) 803-5222 or visit www.volvocars.us/mobility. TTY users are invited to call 1-800-833-0312.

Personal shopper

The Volvo Personal Shopper is dedicated to providing you with a whole new level of shopping convenience. Whether you'd like help identifying the Volvo model that best fits your lifestyle, detailed information on any Volvo model, or a comparison against the competition, Volvo is there to help. We can arrange a Guest Drive for you at your nearest Volvo Retailer. So make the most of your shopping time and call the Volvo Personal Shopper at 1-800-550-5658. (U.S. only)

Volvo Overseas Delivery.

Volvo Overseas Delivery offers a unique way to buy your new custom-built car as well as a unique way to see more of Europe. And when you're done traveling, bring the pleasure of driving a Volvo back home. Purchase any new Volvo as part of the Volvo Overseas Delivery Program and enjoy all this – and more:

- Attractive pricing on US models.
- Two complimentary round-trip tickets with Scandinavian Airlines.
- One free hotel night in Gothenburg, Sweden, the home of Volvo.
- An exciting Volvo Factory Tour or a visit to the new Volvo Brand Experience Center.
- An exclusive VIP delivery experience at the Volvo Factory Delivery Center.
- The opportunity to explore Europe in the comfort and safety of your own Volvo, either with one of our spectacular tours or on your own.
- Extensive complimentary home shipment services. Just leave your car with us. We'll ship it to you the convenient way while you relax and enjoy your complimentary flight back home.

Can you think of a better way of traveling overseas and making your souvenir part of an unforgettable experience?

If you would like to know more, contact your local Volvo retailer, our Customer Care Center (800) 631-1667, or visit www.volvocars.us/mybagsarepacked

A world of colors.



614 Ice White



477 Electric Silver metallic*



472 Oyster Grey metallic*



454 Ruby Red metallic*



493 Caper Green metallic*



466 Barents Blue metallic¹



452 Black Sapphire metallic*



019 Black Stone

* Metallic paint is an option.

Please note: It is not possible to reproduce exact original shades in this brochure. Ask your Volvo retailer to show you samples. As part of our commitment to the environment, the paper used in this brochure is recycled, and color choices were printed directly on the page. This eliminates the need for chemically treated color chips. A small thing perhaps, but then, every little bit helps.

Volvo. for life

VOLVO
Volvo Car Corporation



Mixed Sources
Product group from well-managed
forests, controlled sources and
recycled wood or fibre

Cert no. SGS-COC-003959
www.fsc.org
© 1996 Forest Stewardship Council

WWW.VOLVOCARS.US

Specifications, features, and equipment shown in this catalog are based upon the latest information available at the time of publication. Volvo Cars of North America, LLC reserves the right to make changes at any time, without notice, to colors, specifications, accessories, materials, and models. For additional information, please contact your authorized Volvo retailer.

© 2008 Volvo Cars of North America, LLC. Printed in USA. **MY09G**