

Designed to ensure the safety of all passengers in the cabin

Front SRS air bags enhance safety



Front SRS air bags for the driver and front seat passenger deploy in the event of a strong front impact to minimise injury to both driver and front passenger.

*SRS stands for Supplemental Restraint System.
 *The SRS air bags are supplementary devices to the seat belts. The seat belts must be worn at all times.
 *The front SRS air bags will not deploy in cases of minor impact.
 *In the photo shown, the SRS air bags were intentionally deployed to show their function, and the front passenger seat was set to a reclined position.

Powerful braking performance

Disc brakes (273 mm rotors) ensure outstanding stopping performance. The EBD (Electronic Brake force Distribution) and ABS (Anti-lock Braking System) with brake assist distribute the braking force optimally to the four wheels.

*ABS brake control is not possible when the tyres have exceeded their performance limit. Also, the control distance cannot be shortened.

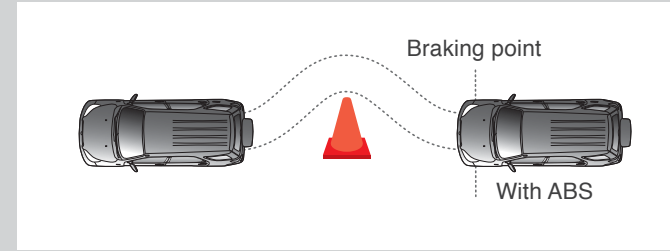

Advanced crash-safety body

To protect occupants in an accident, the cabin has been made extra-rigid and crushable structures have been used in the body's front and rear sections to absorb impact. TERIOS takes crash-safety design a step further with a structure that disperses the impact energy from a collision throughout the body frame.



Three-point ELR front seat belts equipped with pretensioners and force-limiters

In the event of an accident, the pretensioner instantly winds up the seat belt to remove any slack and the force-limiter adjusts the amount of pressure the seat belt applies to the passenger's chests, which both help to mitigate the injuries to the passengers.

Please check with your dealer concerning standard and optional equipment.

Body colours



Silver Mica Metallic (1E7)



Grey Metallic (S37)



Champagne Metallic (T23)



Maroon Mica (R56)



Black Metallic (X12)



White (W09)

Specifications

ITEM	Engine		1.5 L			
	Drive		2WD		4WD	
	Transmission		5 M/T	4 A/T		5 M/T
	Grade		DX	DX	SX	DX SX
Overall length	With soft spare tyre cover	mm	—	4385	—	4385
	With semi-hard spare tyre cover	mm	4425	—	4425	— 4425
Overall width		mm	1695			
Overall height	Without roof rail	mm	—		1695	—
	With roof rail	mm	1745		—	1745
Interior length		mm	2440			
Interior width		mm	1385			
Interior height		mm	1240			
Wheelbase		mm	2685			
Track	Front	mm	1445			
	Rear	mm	1460			
Min. road clearance		mm	200			
Min. turning circle	Kerb to kerb	m	10.2			
	Wall to wall	m	10.6			
Kerb weight		kg	1190	1200	1210	1230 1260
Gross vehicle weight		kg	1800			
Seating capacity		persons	Fr : 2 2nd : 3 3rd : 2			
Engine type	1.5 L 3SZ-VE		Petrol, inline 4-cylinder, DOHC, 16-valve, DVVT			
Total displacement		cc	1495			
Bore x stroke		mm	72 x 91.8			
Compression ratio			10.0			
Max. output		kW/rpm	77/6000			
Max. torque		N·m/rpm	140/4400			
Fuel system			EFI (Electronic Fuel Injection)			
Fuel tank capacity		litres	50			
Steering type			Rack & pinion			
Transmission	5 M/T		Forward 5-speed manual, all synchromesh			
	4 A/T		Forward 4-speed full automatic			
Transmission gear ratio	5 M/T		1st : 3.769 2nd : 2.045 3rd : 1.376 4th : 1.000 5th : 0.838 Rev. : 4.128			
	4 A/T		1st : 2.731 2nd : 1.526 3rd : 1.000 4th : 0.696 Rev. : 2.290			
Final reduction ratio			5.571	5.857	5.571	
Brake	Front		Disc brakes with booster			
	Rear		Drum brakes, leading and trailing			
Parking brake			Mechanically operating on rear wheels			
Suspension	Front		MacPherson-struts with coil springs			
	Rear		5-link rigid axle with coil springs			
Tyres			215/65R16			
Max. speed		km/h	160	155		
Acceleration	0-100 km/h	sec.	12.8	15.3	13.5	
	0-400 m	sec.	18.4	19.7	18.9	

Note: Daihatsu reserves the right to make changes at any time, without notice, in prices, colours, materials, equipment, specifications and models, and also to discontinue models. This publication is for international usage, and some specifications and illustrations do not necessarily conform with the models sold in your market.

Dimensions

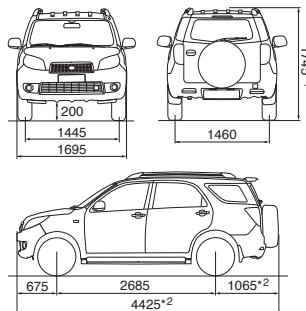

*1: With roof rail
 *2: With semi-hard spare tyre cover
 Unit: mm



Broaden your horizons with an SUV



TERIOS

7seater

Innovation for Tomorrow

2638-00601

DAIHATSU MOTOR CO., LTD.
 1-1, DAIHATSU-CHO, KANDA, OSAKA, 563-8651, JAPAN
www.daihatsu.com

TERIOS *7seater*



With an exterior combining sophisticated style with the dynamism of an SUV, the TERIOS fits perfectly whether you're out in nature or in the heart of the city. Outstanding performance makes driving exciting, on road and off. The interior accommodates seven in comfort at all seating positions. Whether you're driving or just along for the ride, the TERIOS will keep you satisfied.

TERIOS 7seater



Outstanding functionality and comfort come together in one incredible vehicle.



Second- and third-row seats can easily be arranged to accommodate various combinations of passengers and luggage.

Second-row seat



The second-row seat makes it easy to get into and out of the vehicle.

The second-row seat can be stowed with a single touch for easy access to the third-row seat. The seat can also be stowed from the third-row seat, ensuring that getting out of the TERIOS is easy.

Third-row seat



The third-row seat can also be stowed to make more room for luggage.

Stowing the third-row seat increases room for luggage to 320 litres (VDA). Don't worry if you suddenly need to fit more in—an easy, two-step process makes stowing the seat a quick and painless affair.



Third-row seatbacks are designed to accommodate a wide variety of vehicle uses.

The third-row seatbacks can be folded down separately to enlarge the cargo space.

Combining quality with functionality

Designed for maximum driver and passenger convenience and comfort, the TERIOS's modern, sporty interior excels in ease of use.



Illuminated lamps are used in the photograph to illustrate their functions.

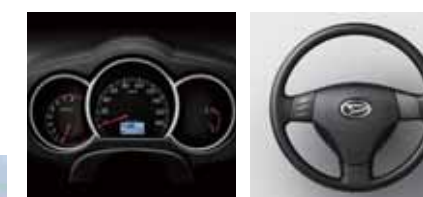

Triple meters Urethane steering wheel (with air bag and audio controls)



5 M/T gearshift 4 A/T gearshift lever



Audio system and clock Dual air conditioner

Appealing package delivers comfort whether you're driving or riding.

Features a long cabin design that accommodates seven adults while preserving ease of driving.

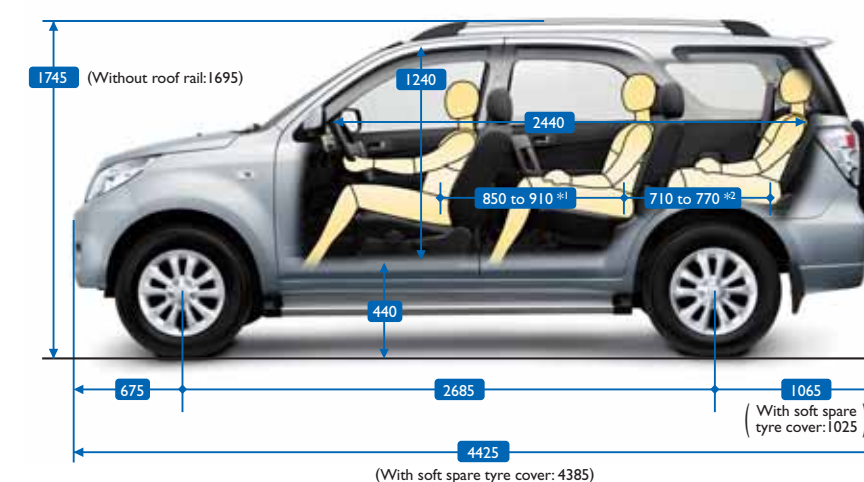

*1: Distance between front-seat and second-row seat occupants
 *2: Distance between second-row seat and third-row seat occupants

Spacious front seats

The front seats boast room to spare so that passenger and driver can ride in comfort without bumping elbows, even with adults in both seats.

Wide track for increased stability

The tyres have been moved toward the outside of the vehicle's body for a wider track, creating a combination of driving stability and powerful style.

High eye-point for a better field of view

A high hip-point gives the driver a wide, 36.7° vertical viewing angle. The resulting unobstructed field of view enhances vehicle safety.



*3: Distance between front-seat occupants

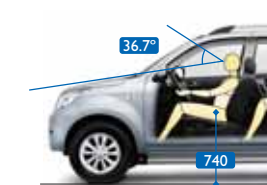

(Unit: mm)

Level of Performance and Safety that makes TERIOS a Pleasure to Drive

1.5-litre DVVT petrol engine with power to spare.
 1.5-litre DVVT engine of the TERIOS has more than enough power to deliver a spirited, satisfying ride. With maximum output of 77/6000 (kW/rpm) and maximum torque of 140/4400 (N·m/rpm), this engine supplies ample torque at low to mid-rpm and is also able to provide smooth, responsive acceleration at high rpm. You can enjoy an exciting ride whether you're traveling off-road, driving in the city, or cruising at high speeds.

Full-time 4WD system with centre differential lock for superb off-road drivability.

Boasting full-time 4WD and a centre differential lock, TERIOS delivers superb drivability on rough roads, quick acceleration from a standing position, and outstanding high-speed stability. The centre differential prevents occurrence of the "tight corner braking phenomenon."^{**} In thick mud or on a deeply rutted road, just touch a button to switch on the differential lock. This connects the front and rear wheels directly, giving the vehicle better traction.

**A condition in which the difference in rotational speeds between the front wheels and rear wheels causes a braking effect.

How the full-time 4WD system with centre differential lock works

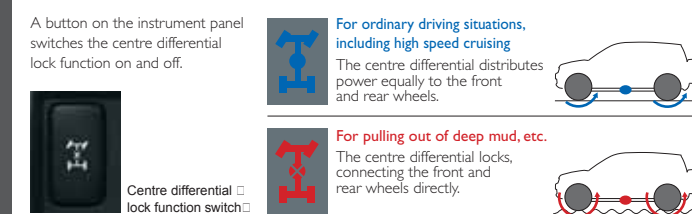

Comfort-optimised suspension

The suspension that supports the TERIOS's driving stability was developed through repeated test-driving on a variety of road surfaces. The result is a suspension system that minimises fatigue as much as possible on long-distance drives and also improves both the comfort of the ride and driving stability.

Built for driving on rough terrain

The front and rear overhangs have been made as short as possible and the ample road clearance give the TERIOS large approach and departure angles. This reduces the damage to the bumpers and undercover when driving in places with high obstacles, such as large stones or when climbing up a rocky hill, etc.

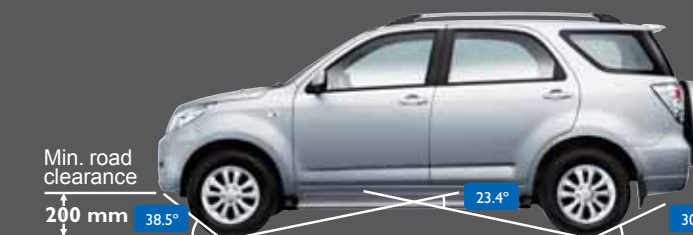

Please check with your dealer concerning standard and optional equipment.

With an exterior combining sophisticated style with the dynamism of an SUV, the TERIOS fits perfectly whether you're out in nature or in the heart of the city. Outstanding performance makes driving exciting, on road and off. The interior accommodates seven in comfort at all seating positions. Whether you're driving or just along for the ride, the TERIOS will keep you satisfied.